

FC1036



**2 IN 1**  
TRANSFORMS



**COLLECT 5 MODELS**  
TO COMBINE RELOADED BERSERK

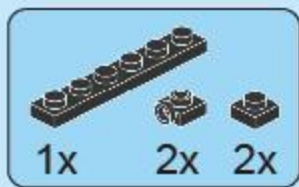

A1

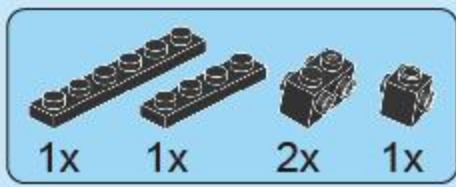
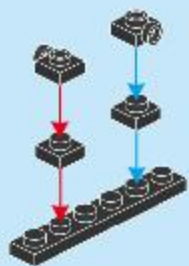

A2

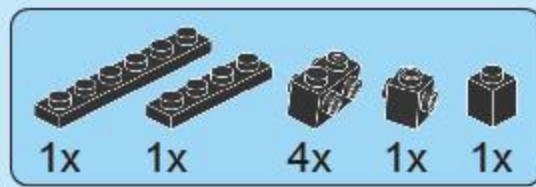
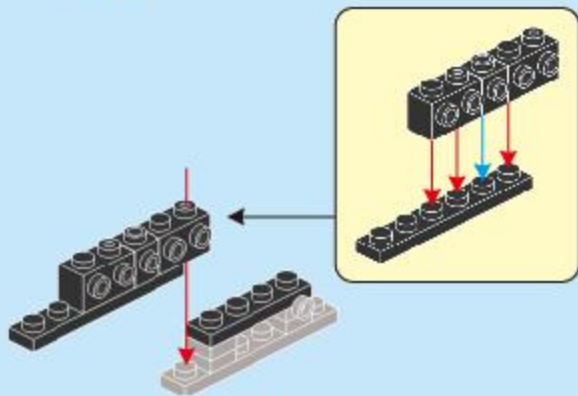

A3

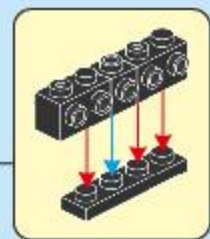
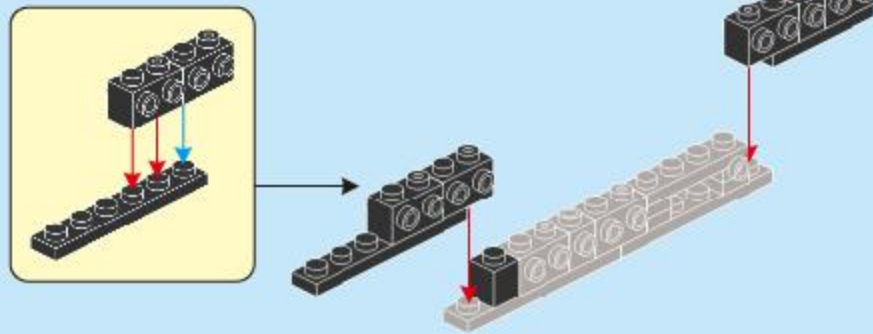

A4

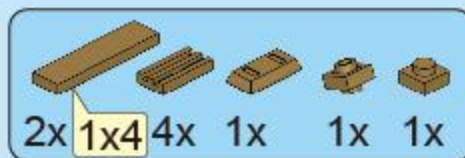
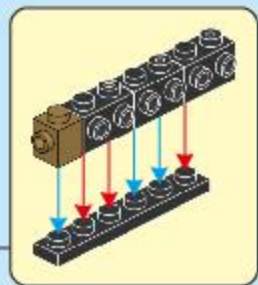
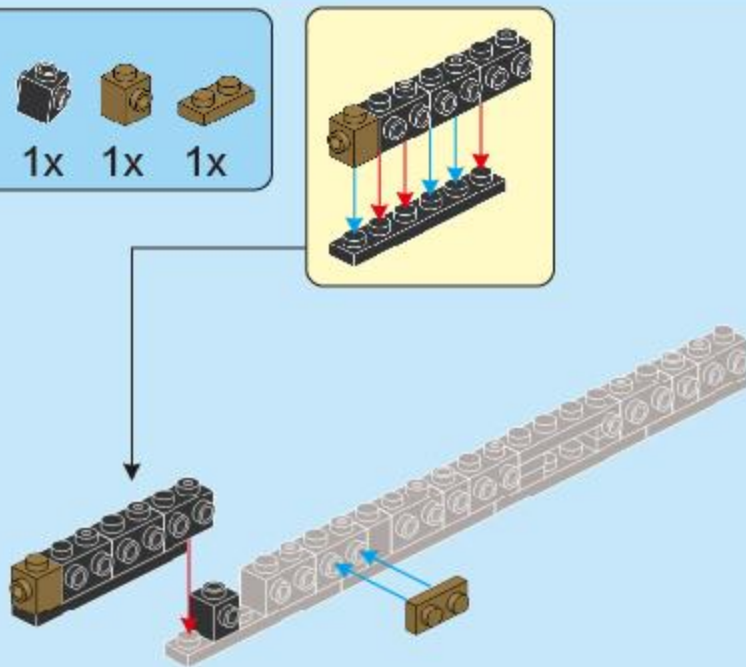

A5

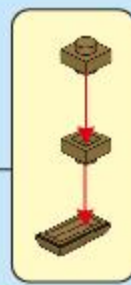
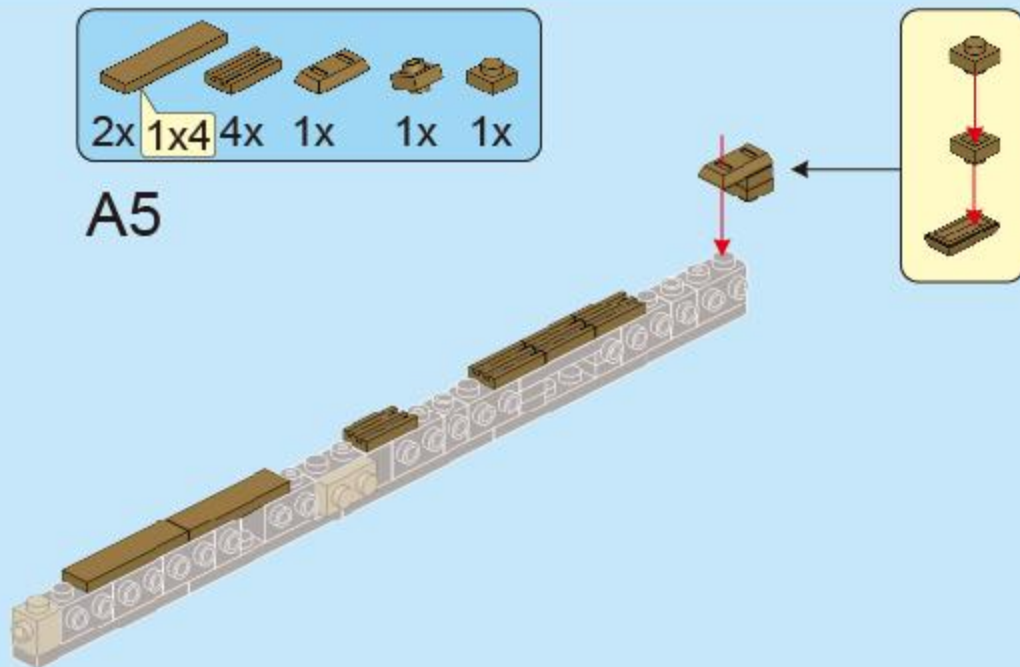

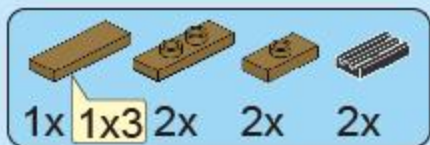

A6

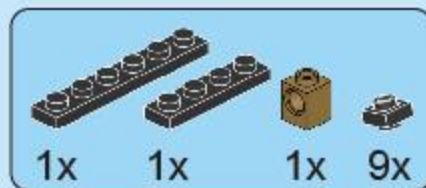
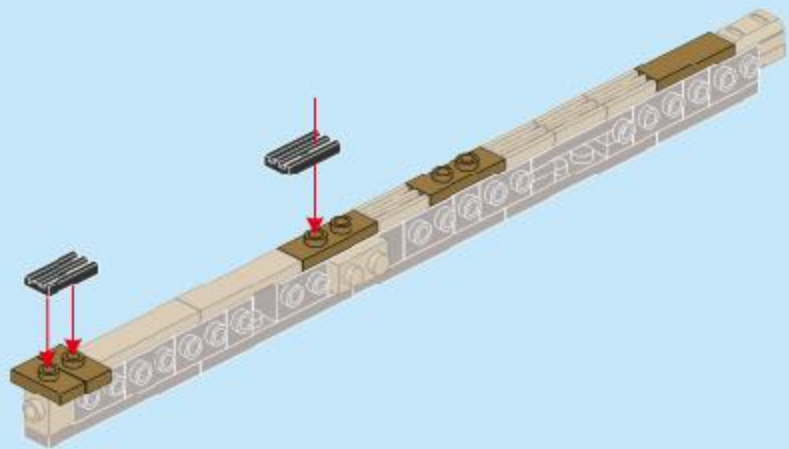

A7

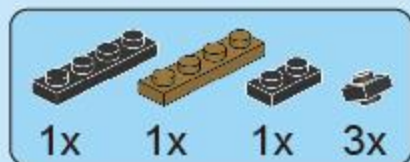
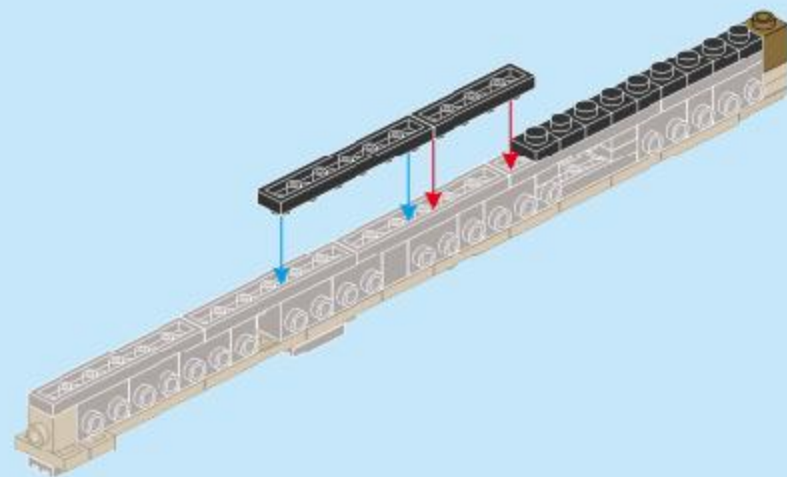

A8

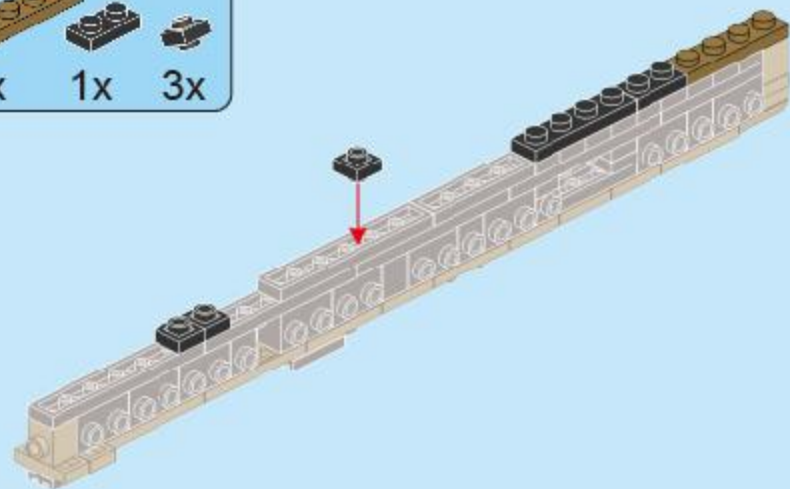

A9

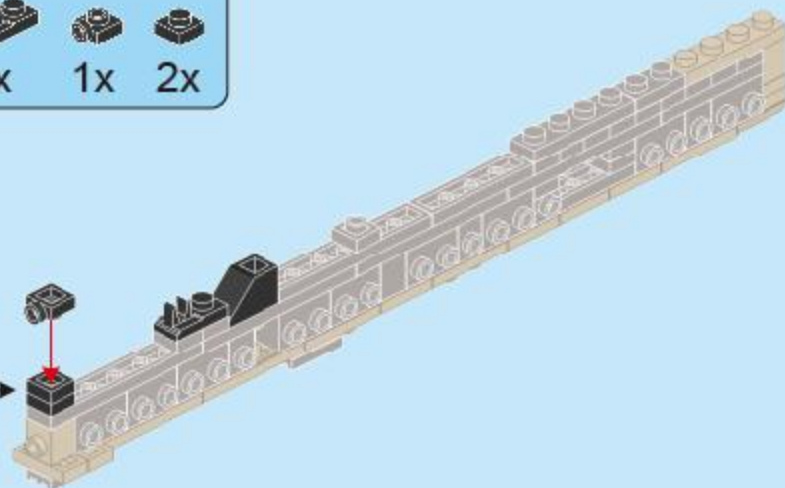

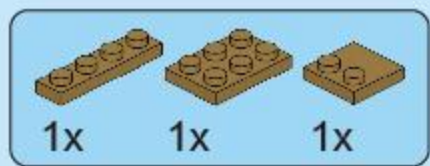

A10

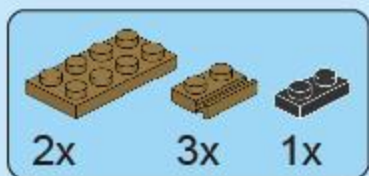
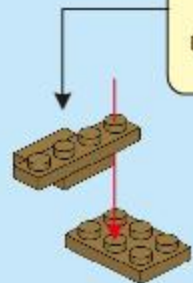
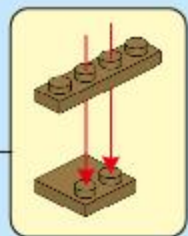

A11

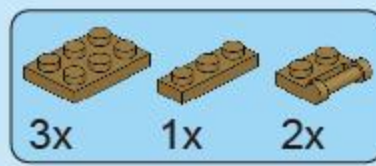
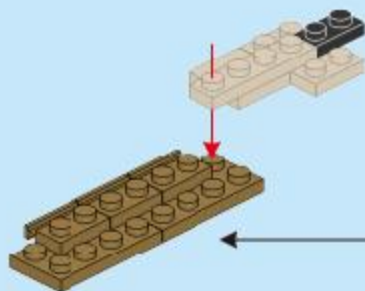
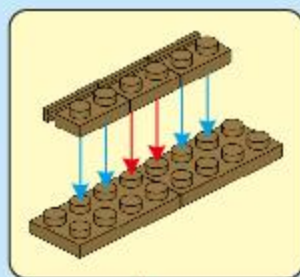

A12

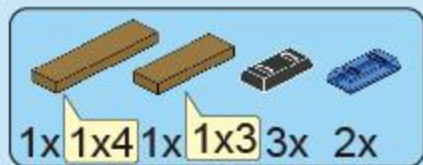
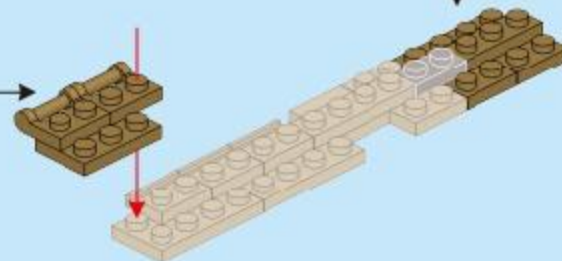
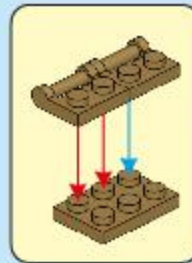
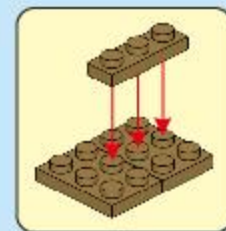

A13

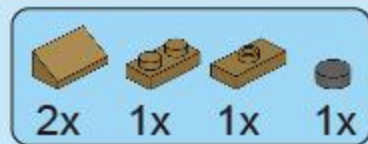
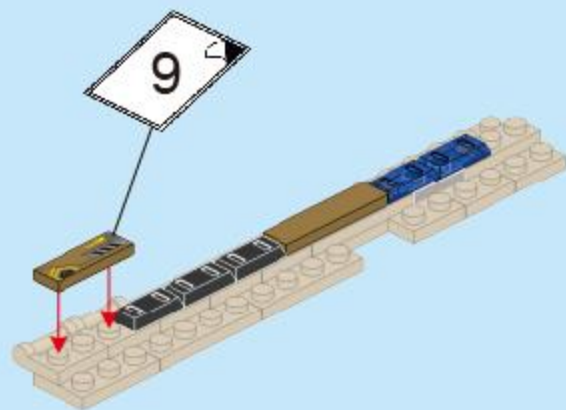

A14

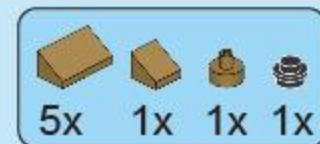
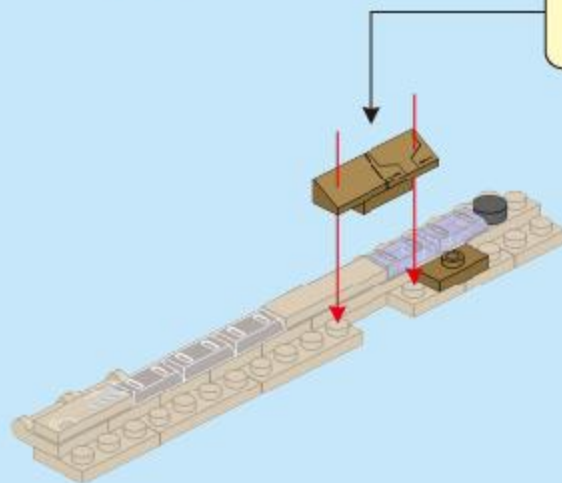
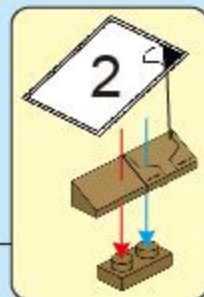

A15

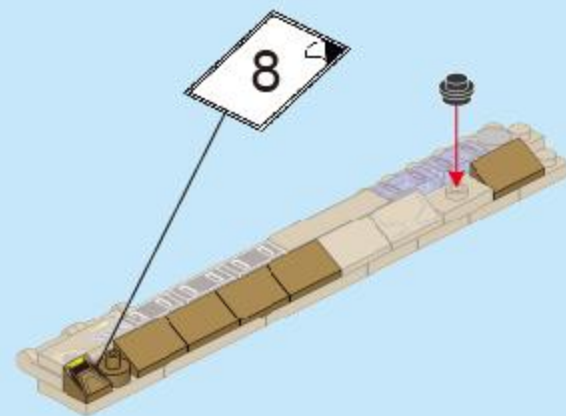

A16

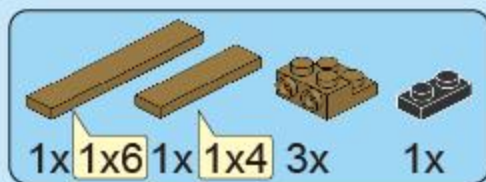
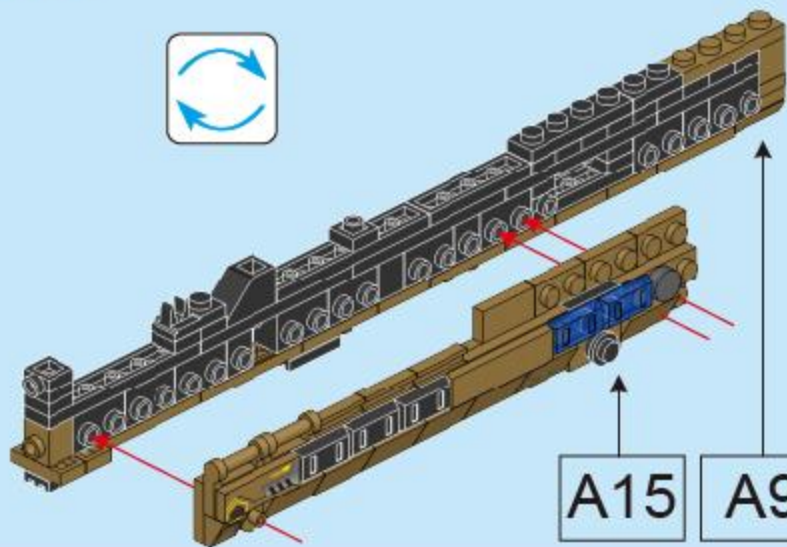

A17

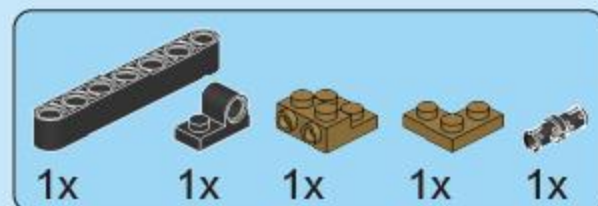
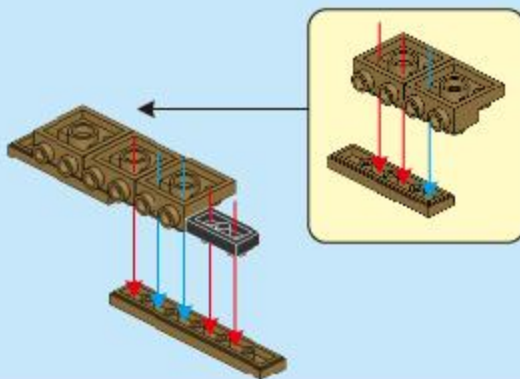

A18

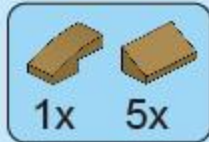
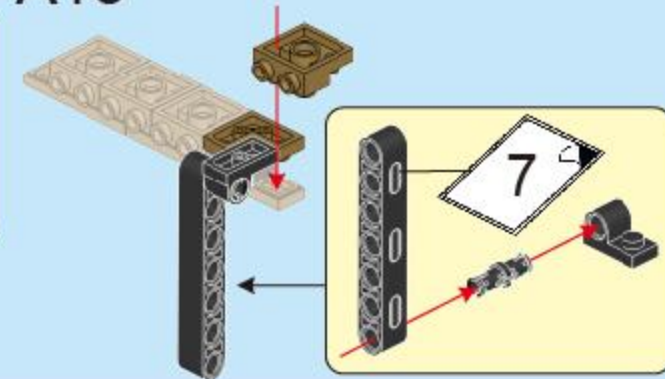

A20



A16

A19

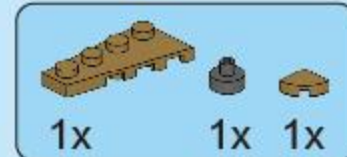

A21

A19

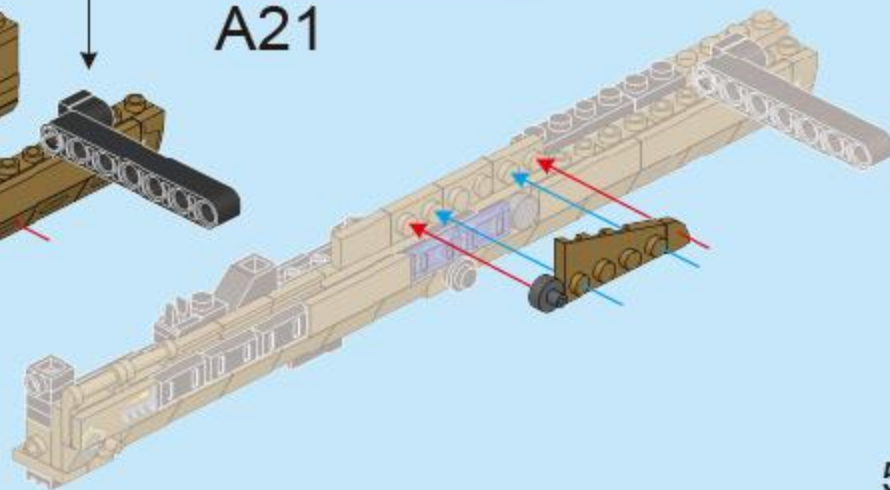
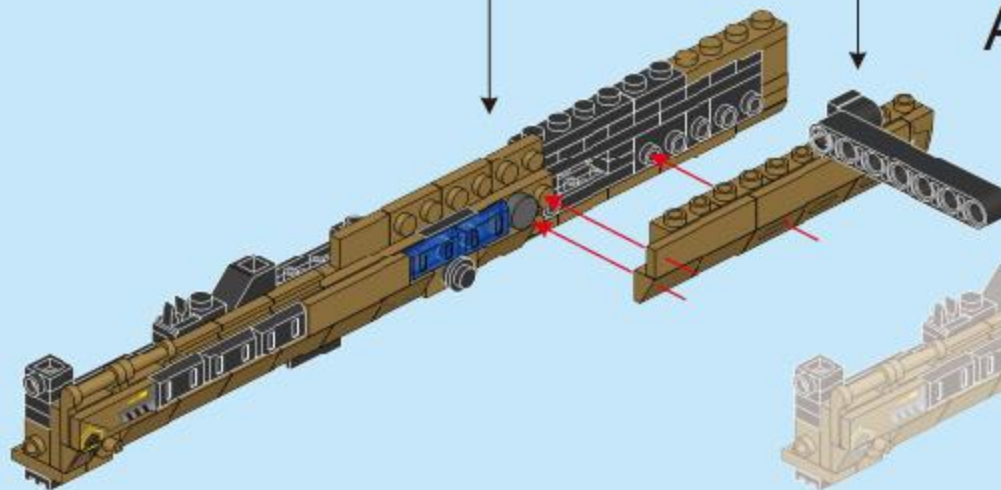
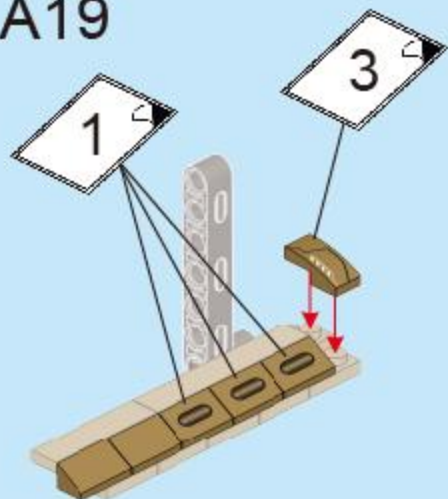

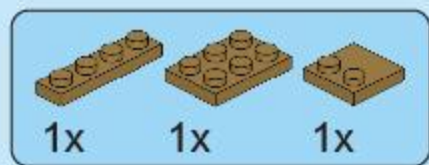

A22

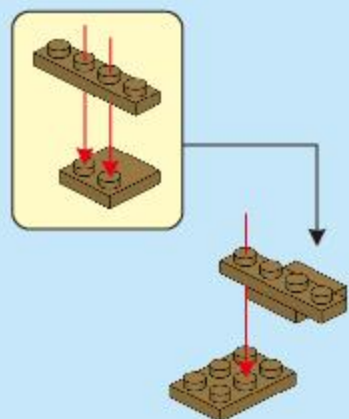

A23

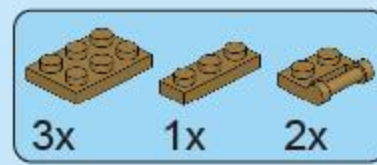
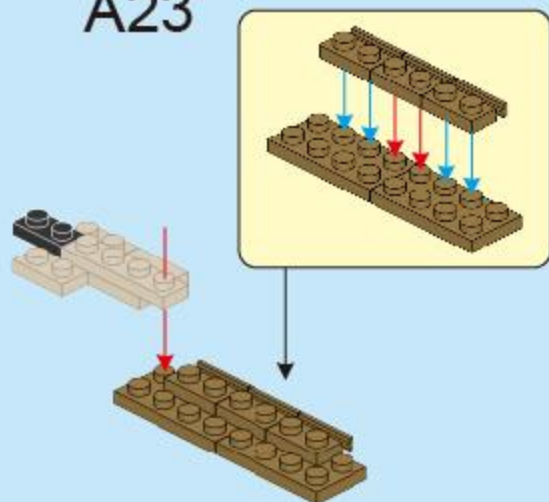

A24

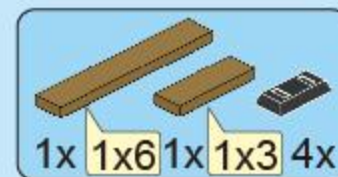
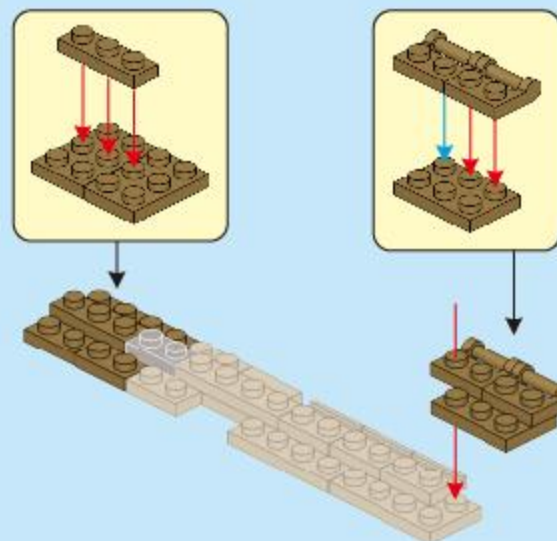

A25

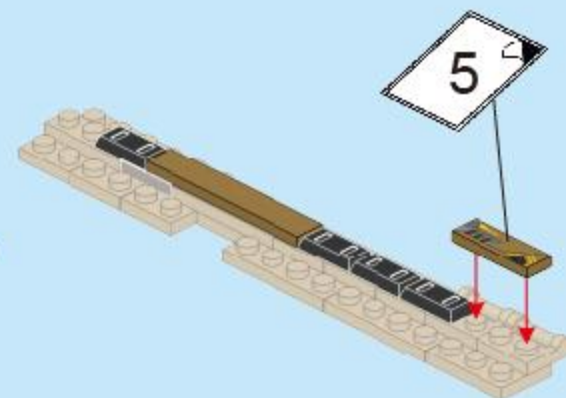

A26

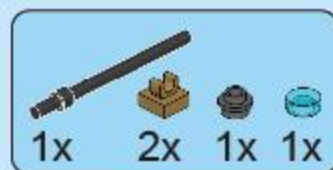
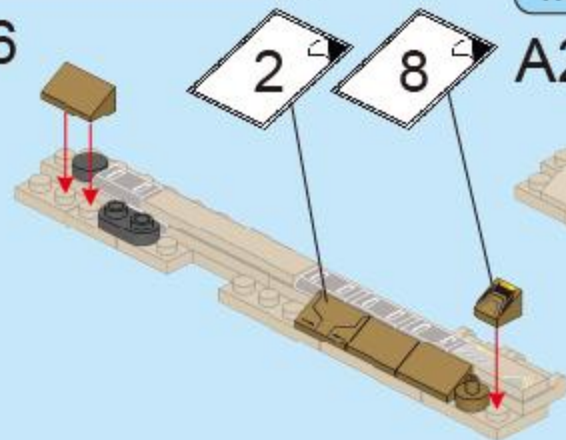

A27

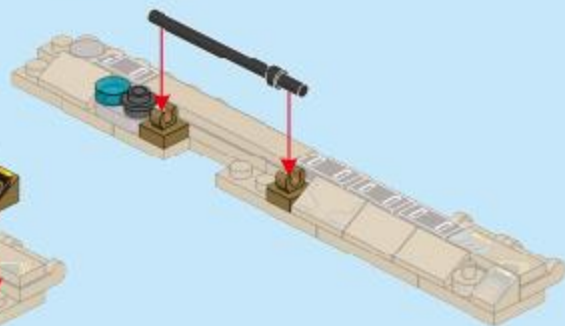

A28

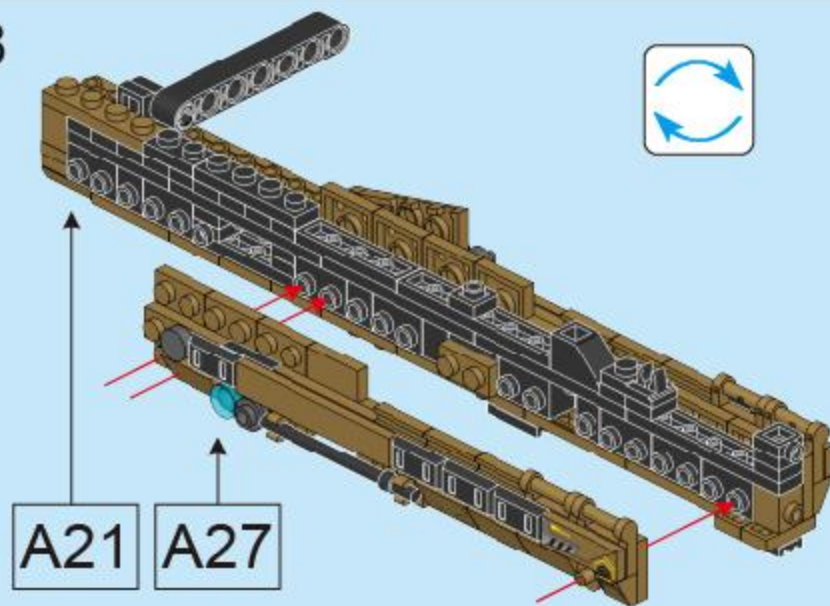

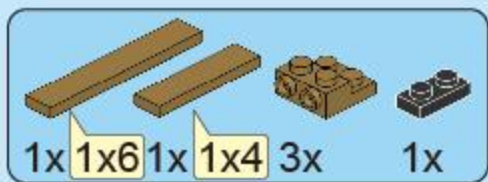

A29

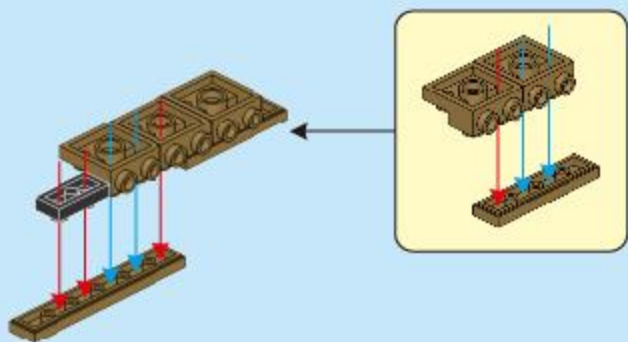

A30

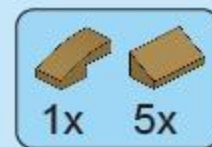
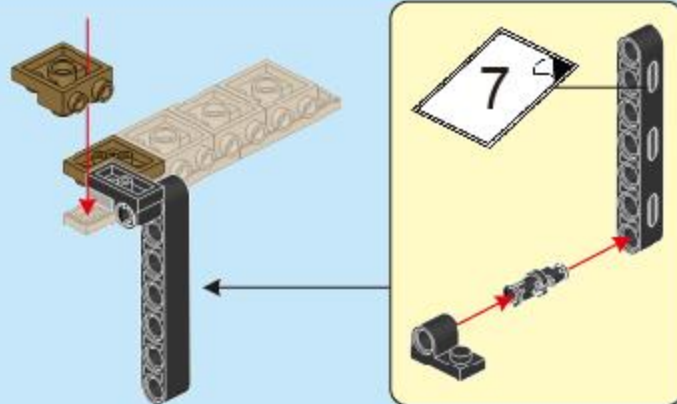

A31

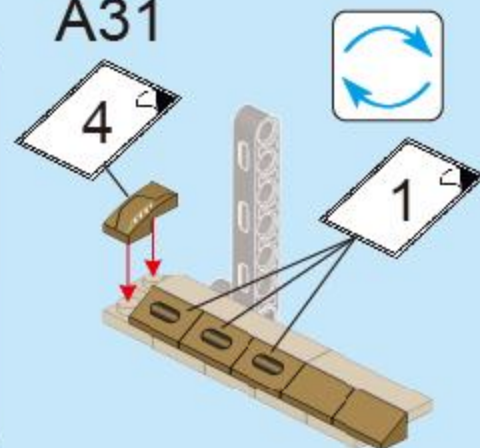

A32

A31

A28

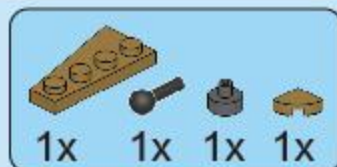
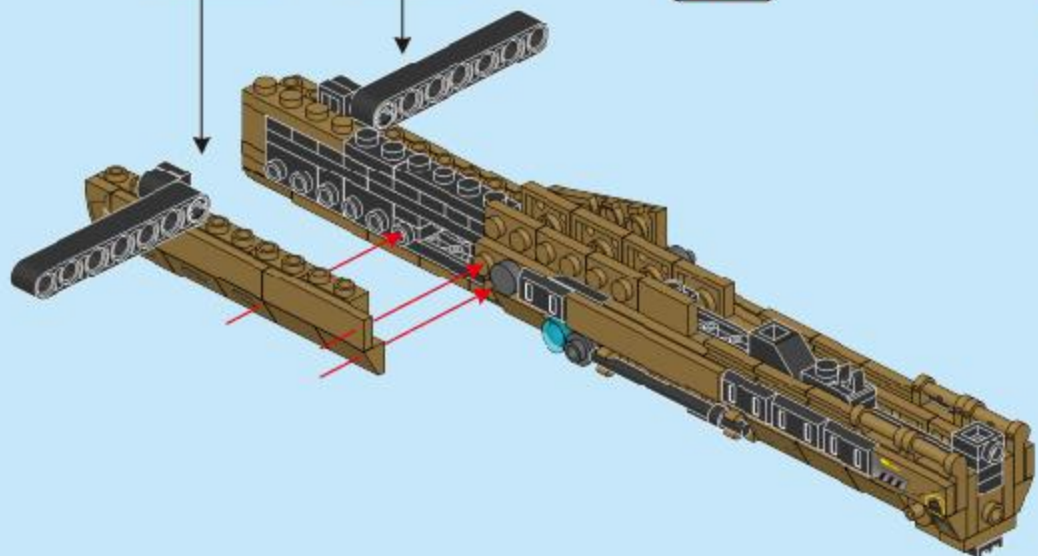

A33

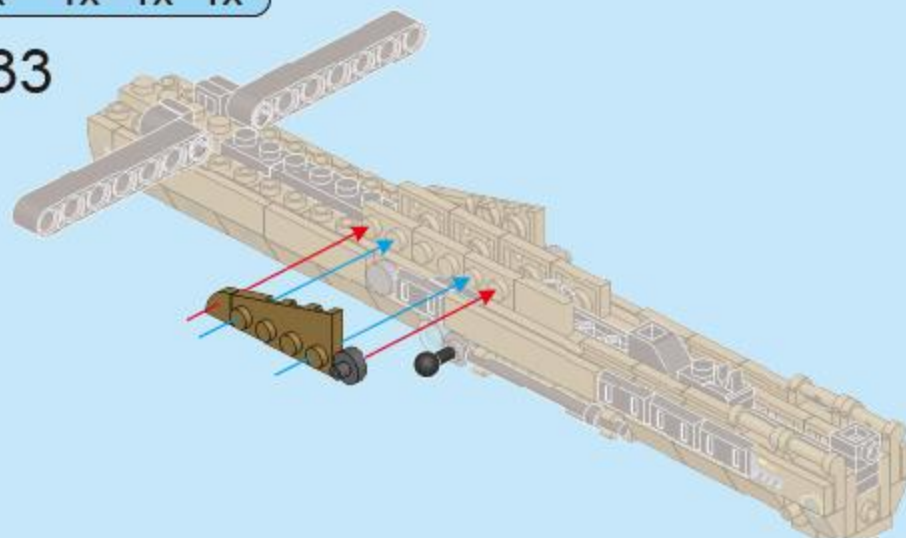



A34

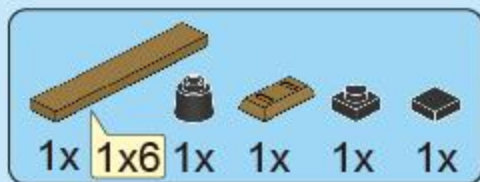
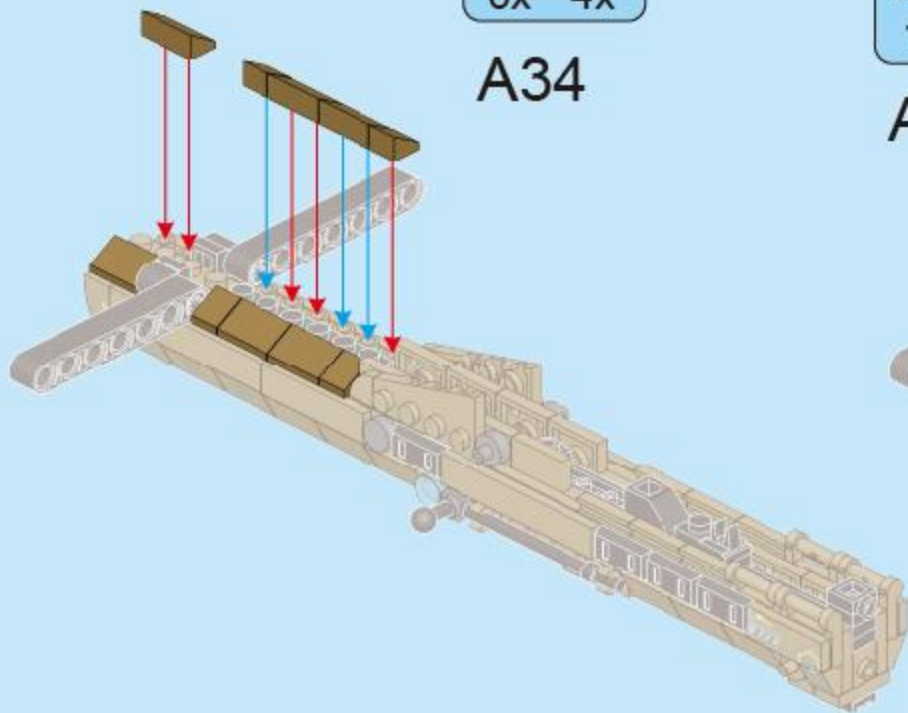

A35

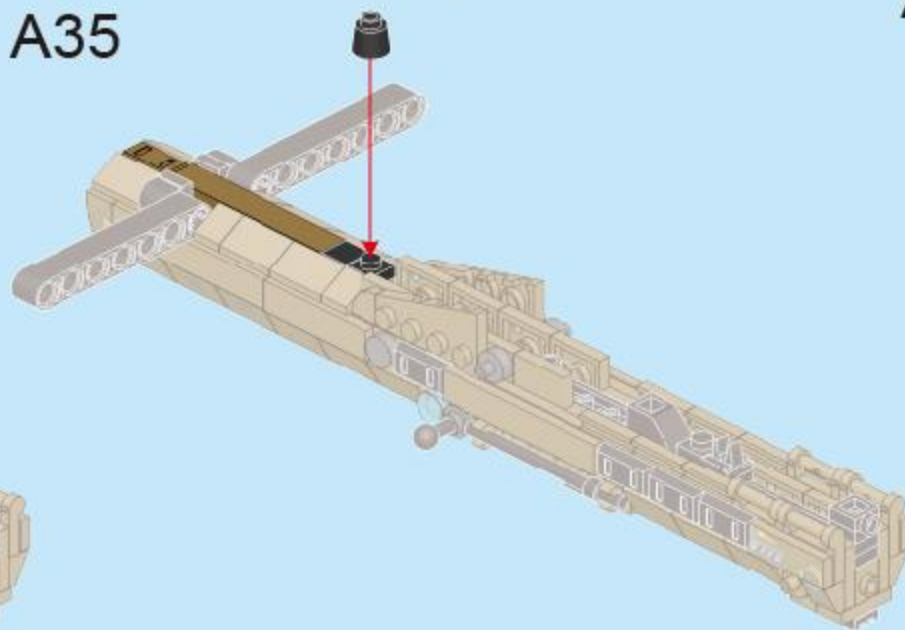

A36



A37

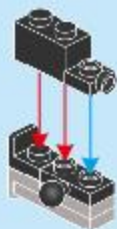

A38

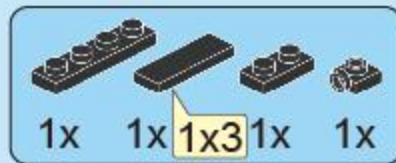
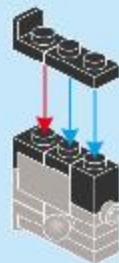

A39

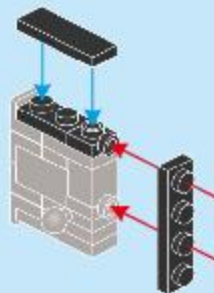

A40

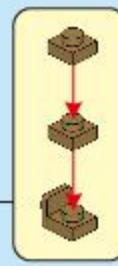
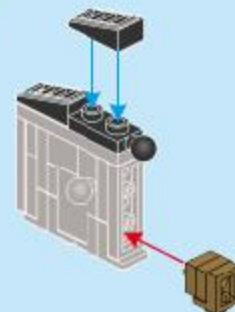



A41

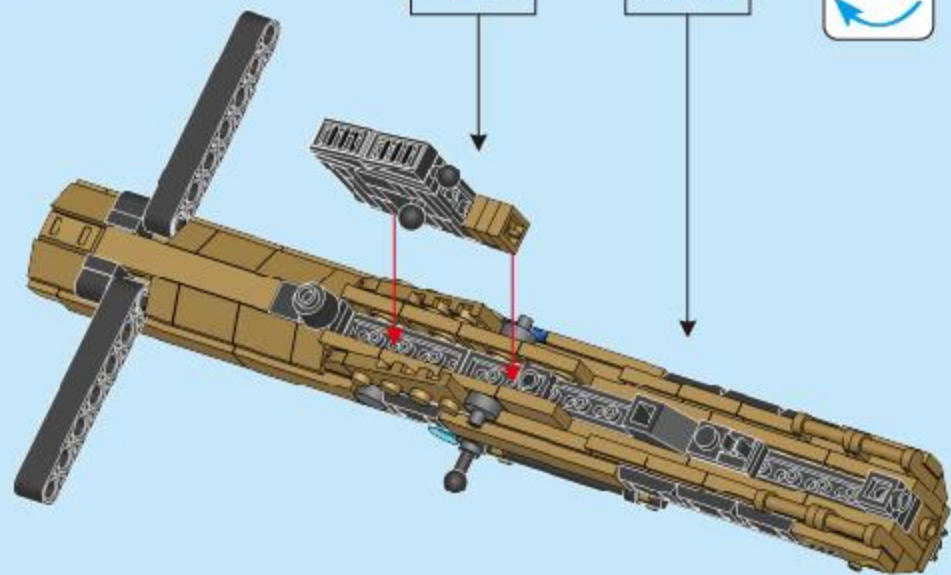

A40

A35

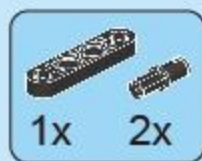

A42

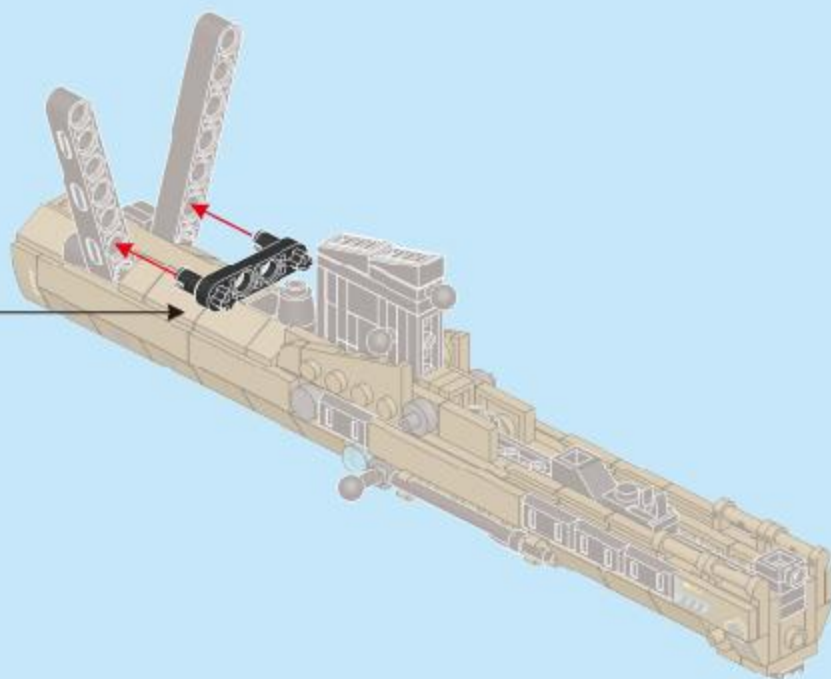
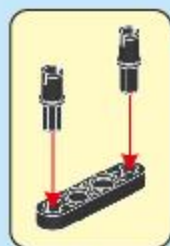

A43

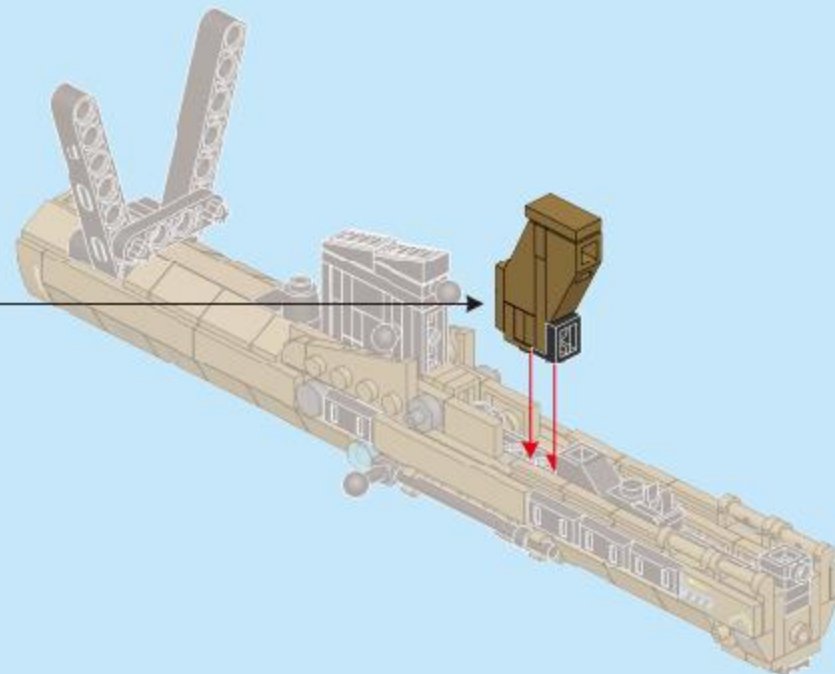
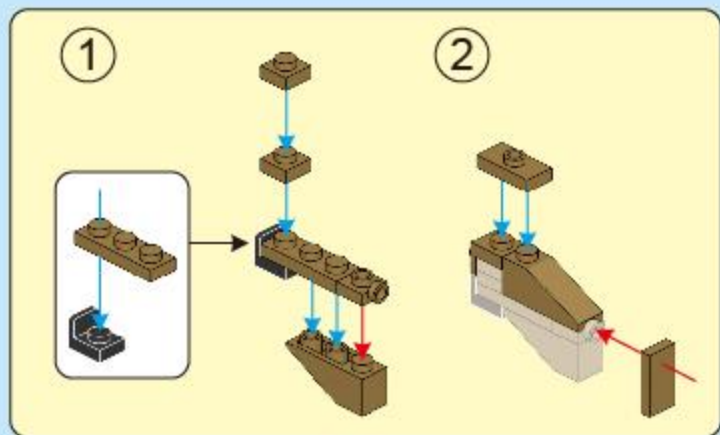



A44

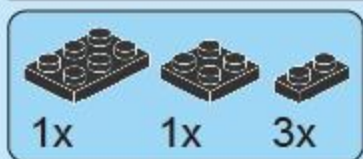
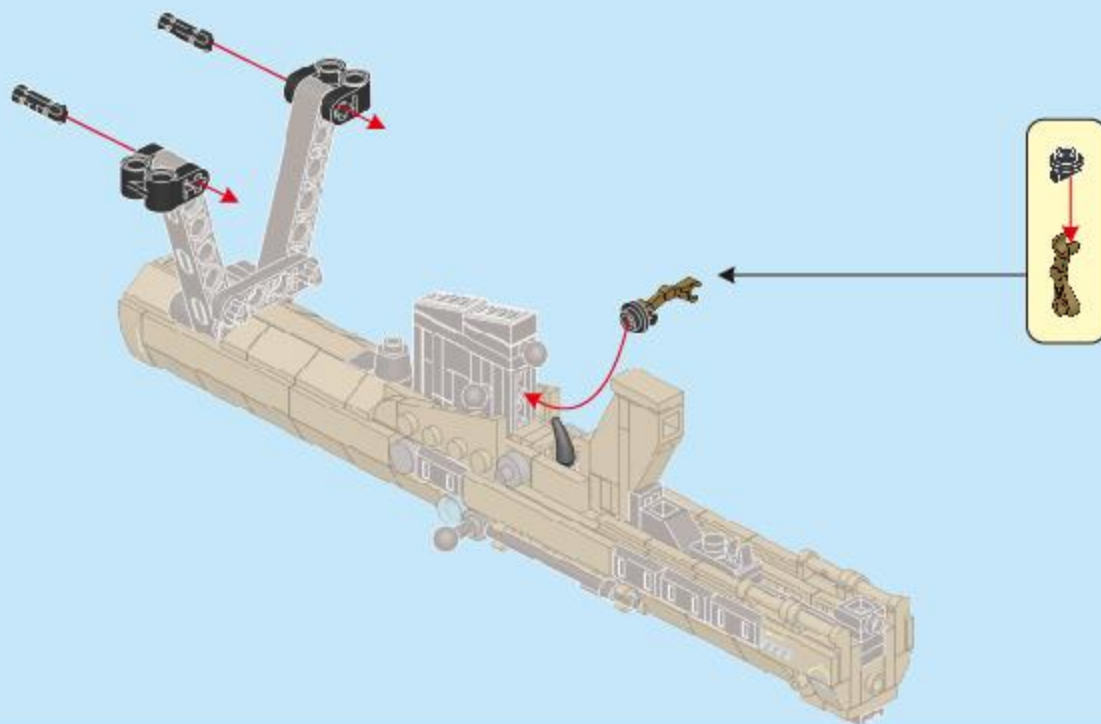

A45

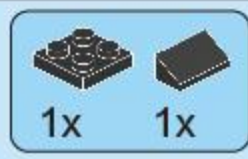
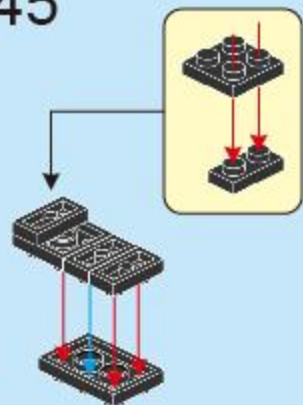

A46

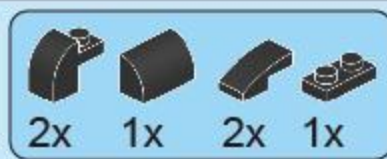
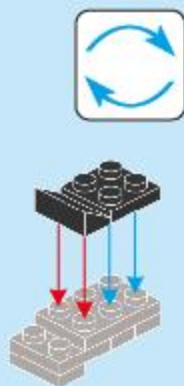

A47

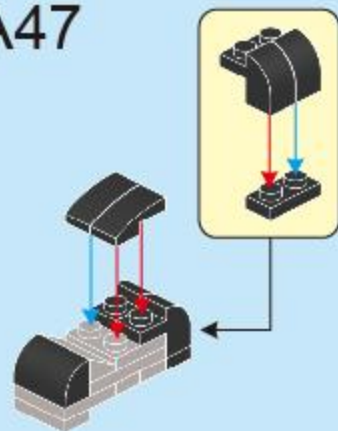

A48

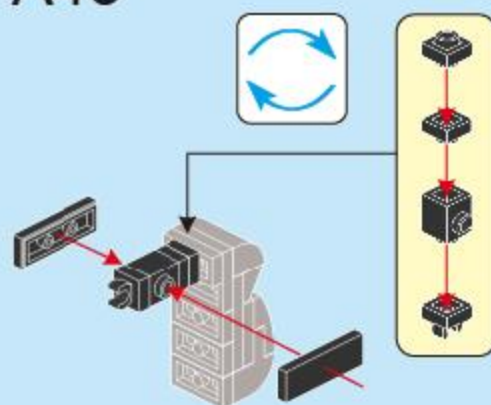

A49

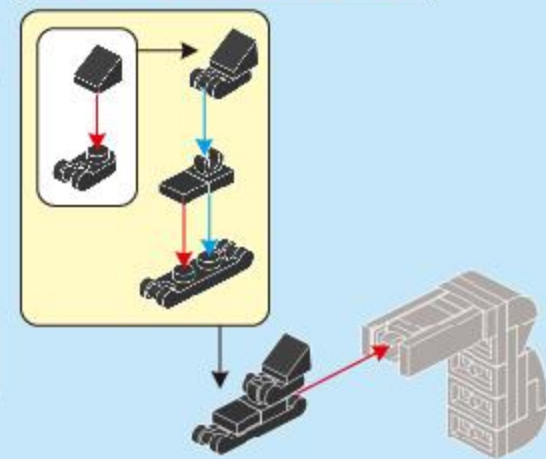

A50

①

A44

A49

②

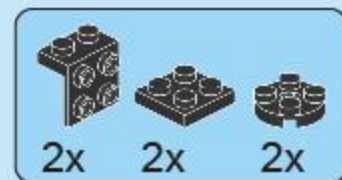
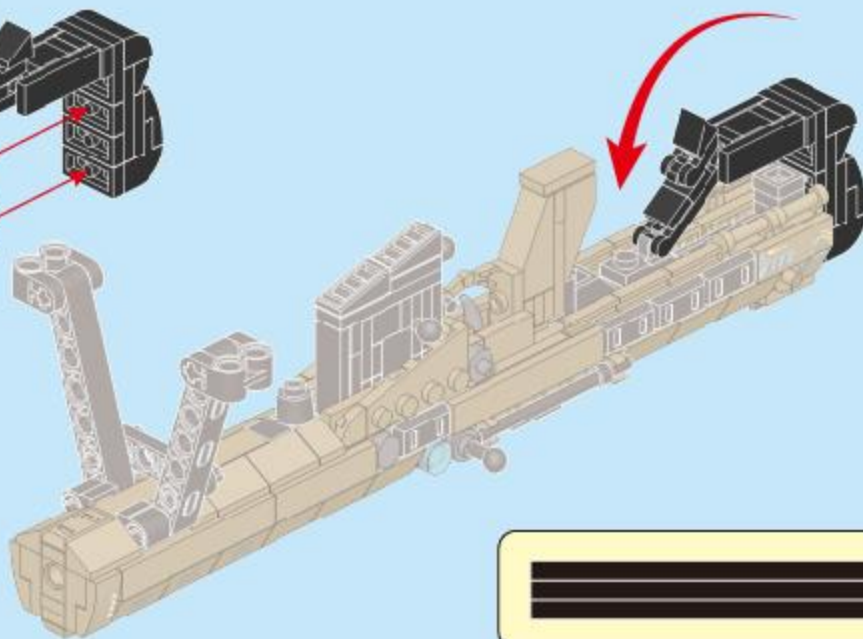
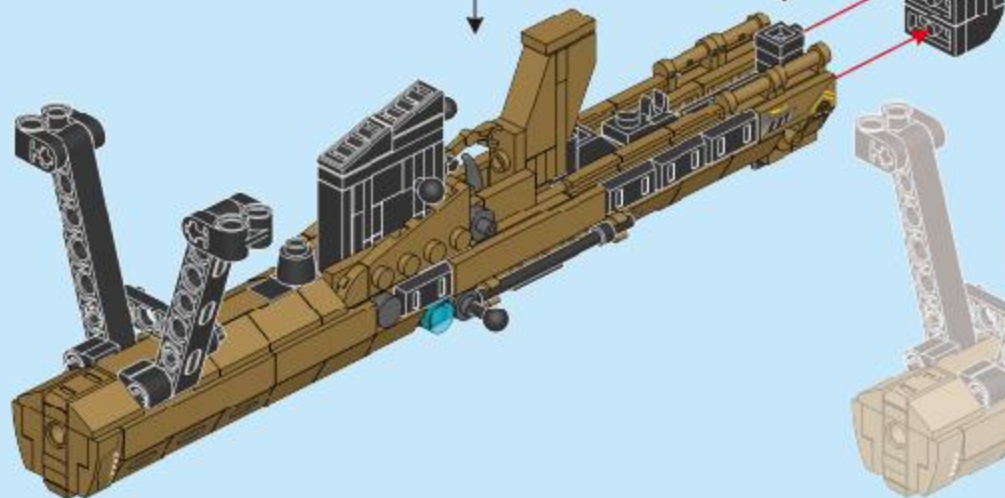

A51

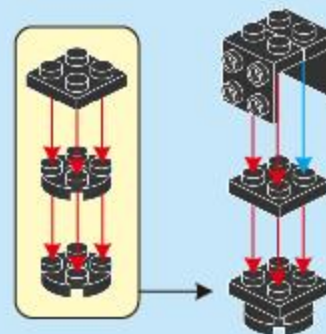

A52

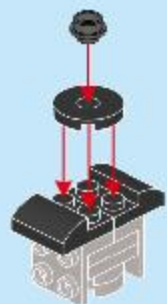

A53

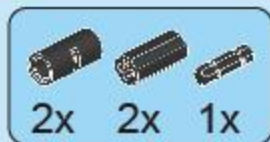
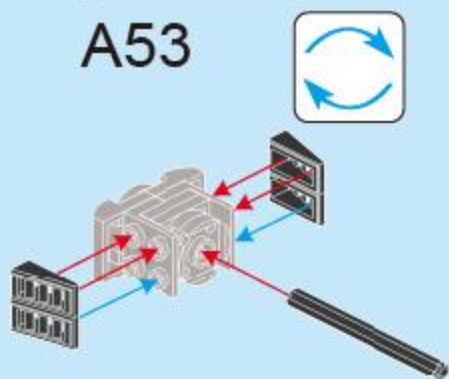

A54

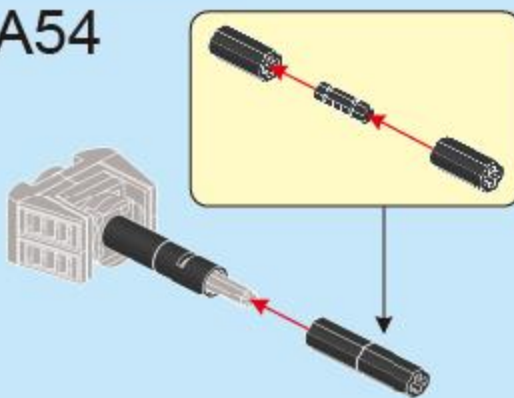

A55

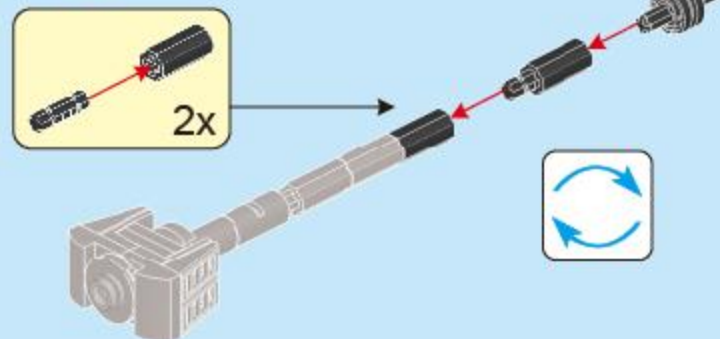



A56

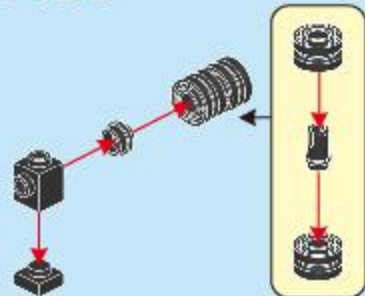

A57

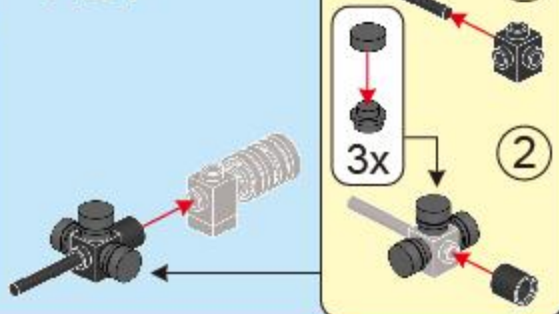

A58

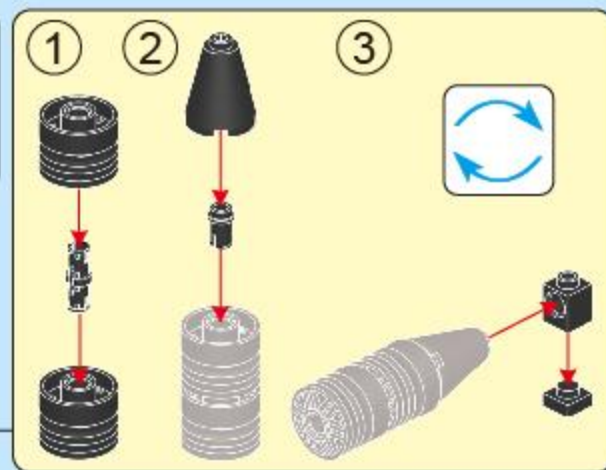
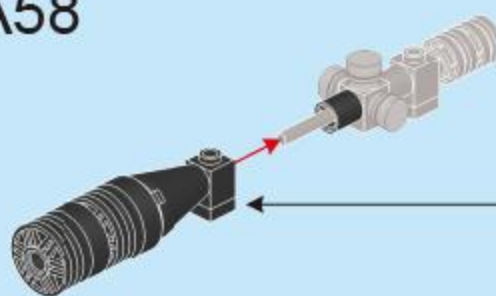

A59

A55

A58

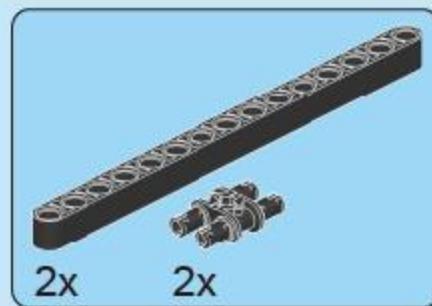
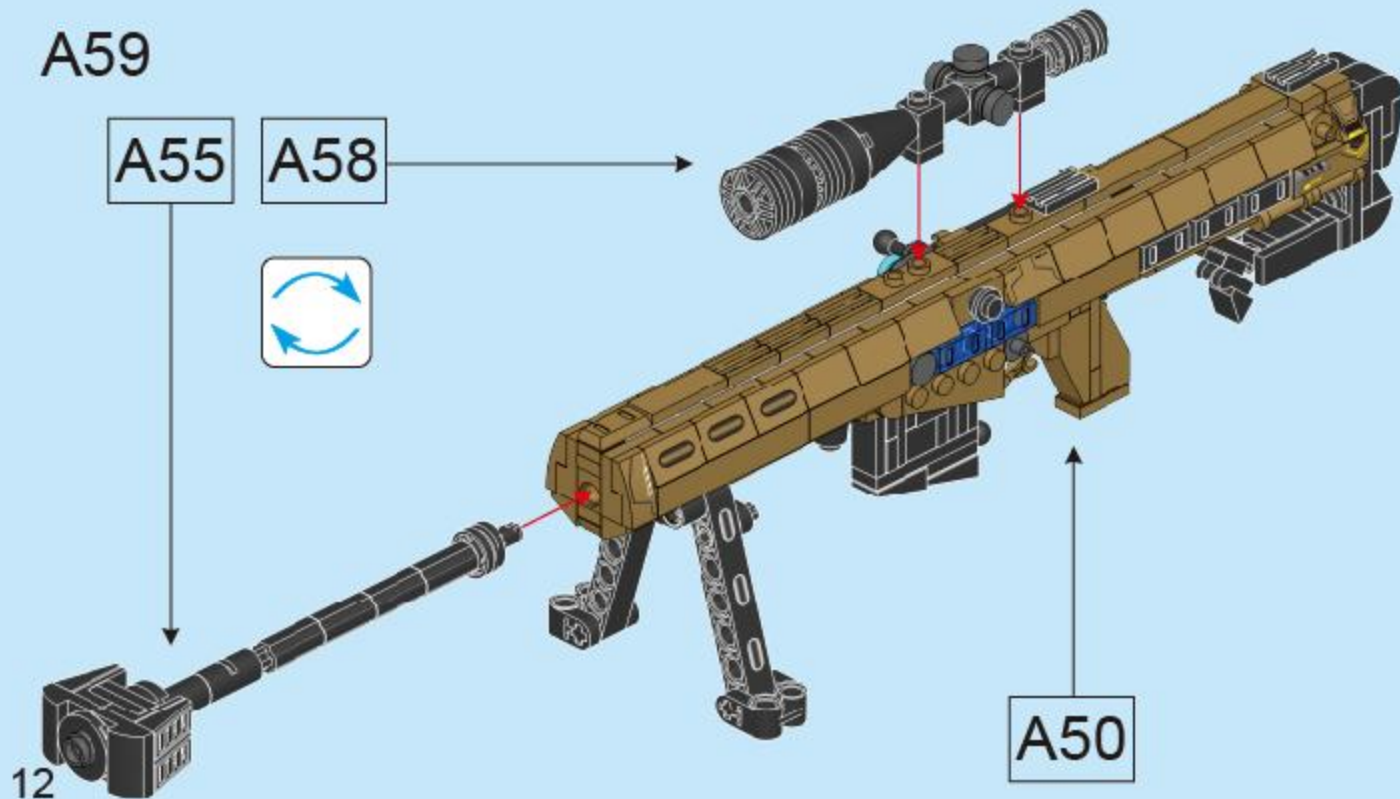

A60

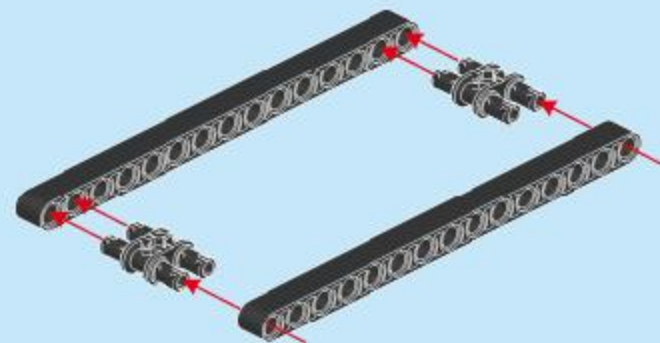

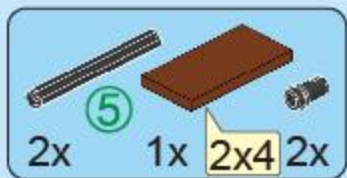

A61

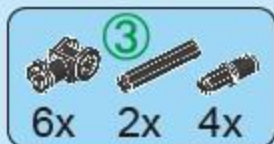
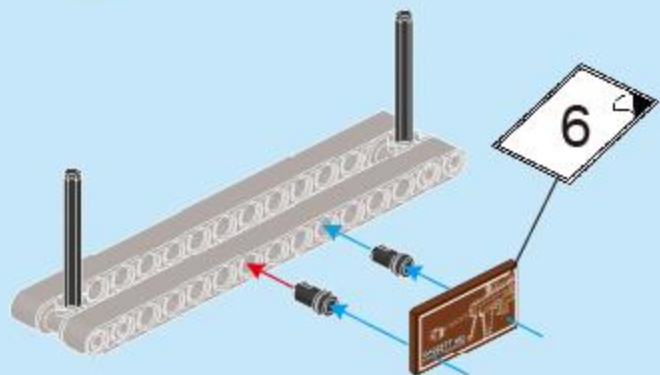

A62

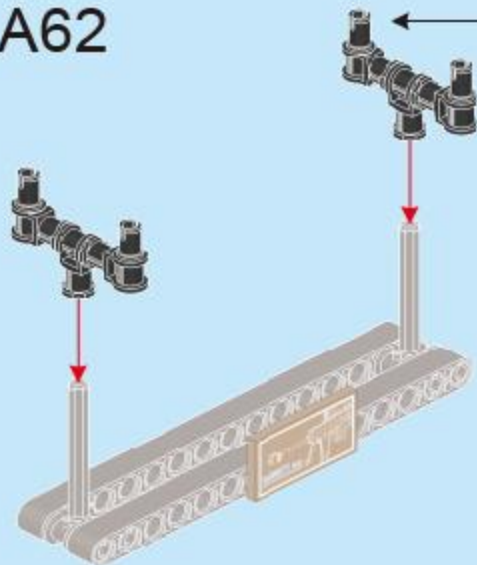
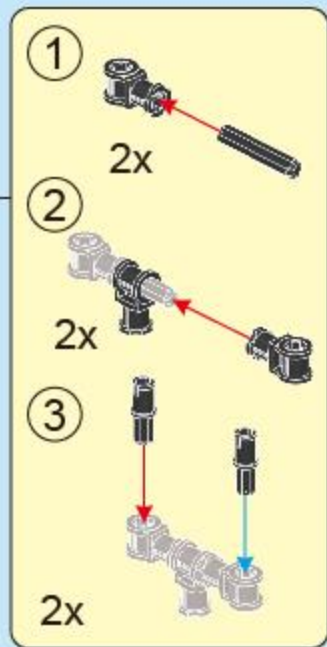

A63

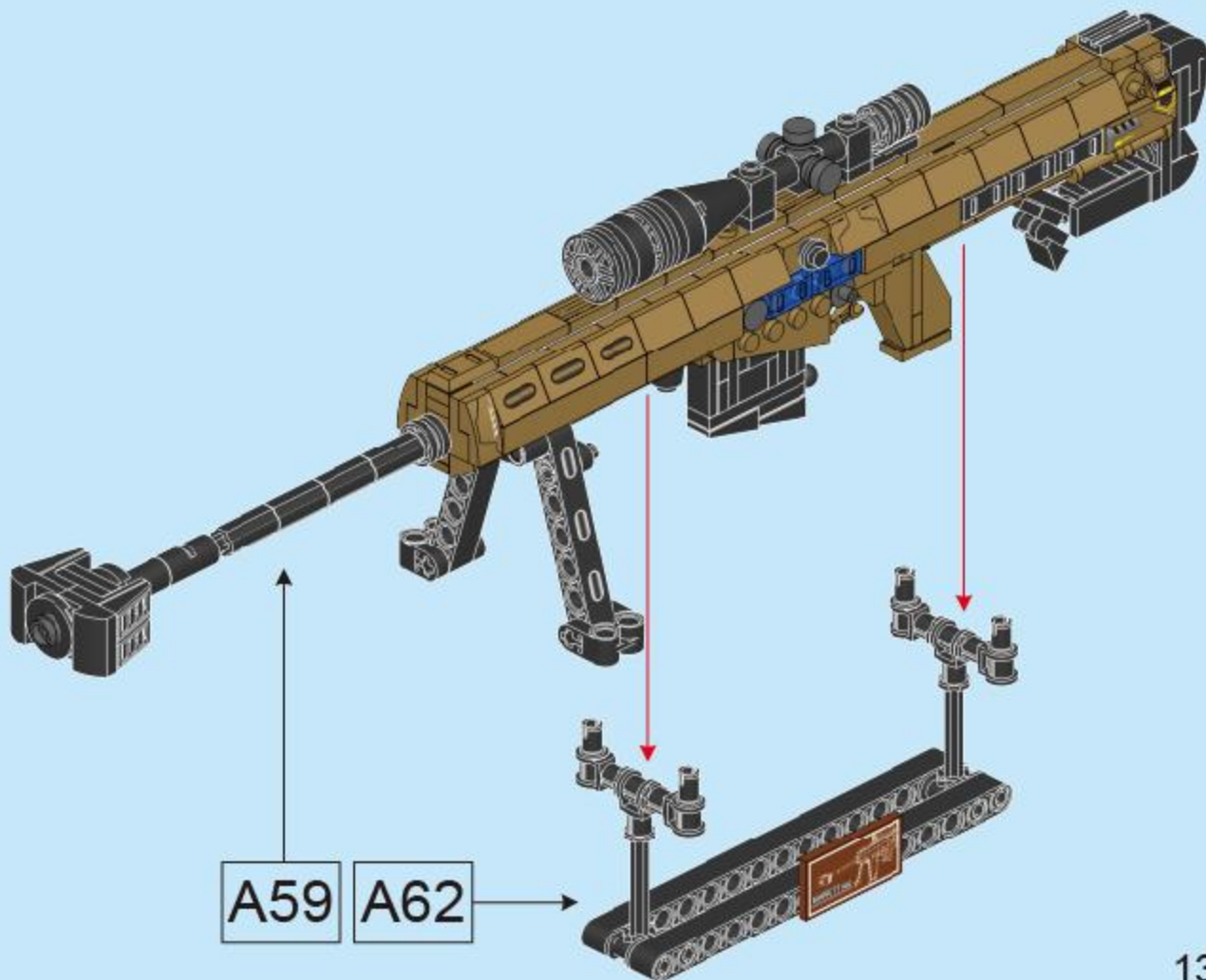
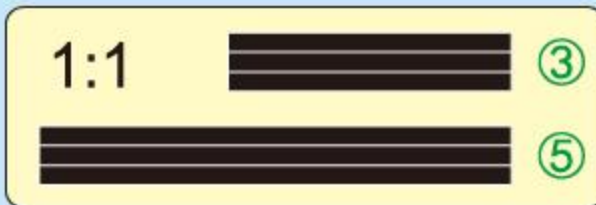

A

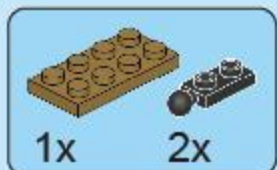

B1



B2

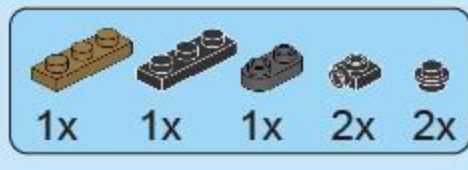

B3

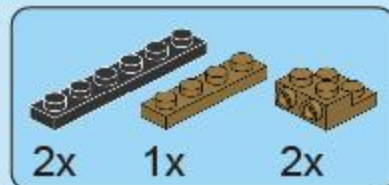

B4

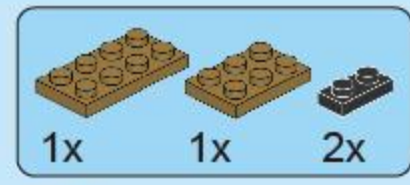

B5

14

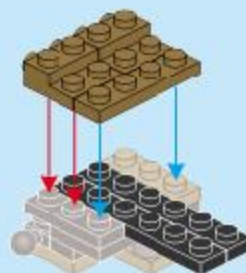
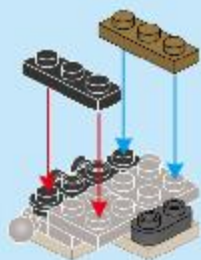
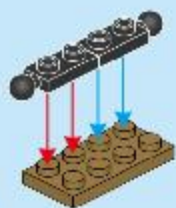

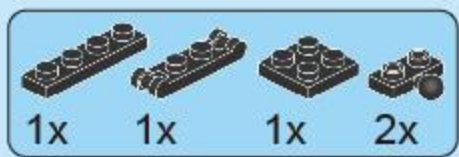

B6

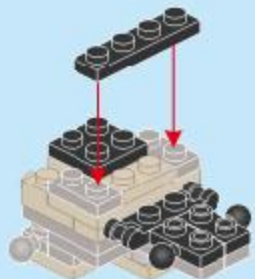

B7

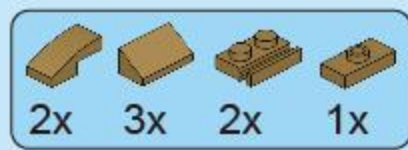
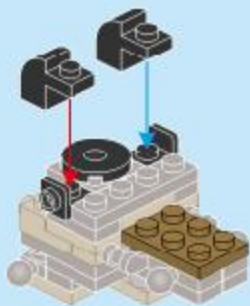

B8

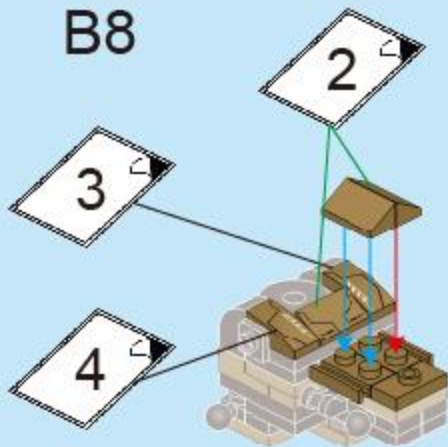

B9

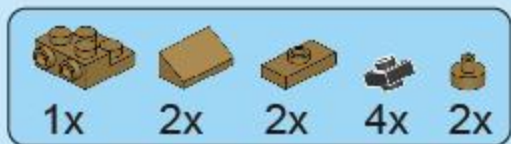
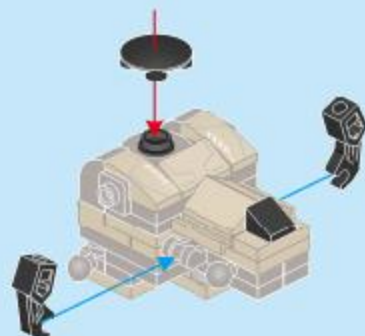

B10

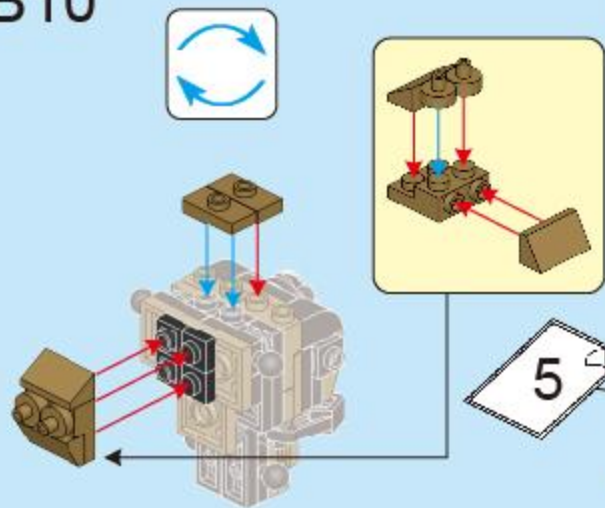

B11

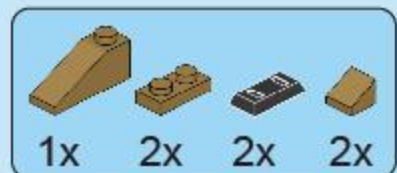
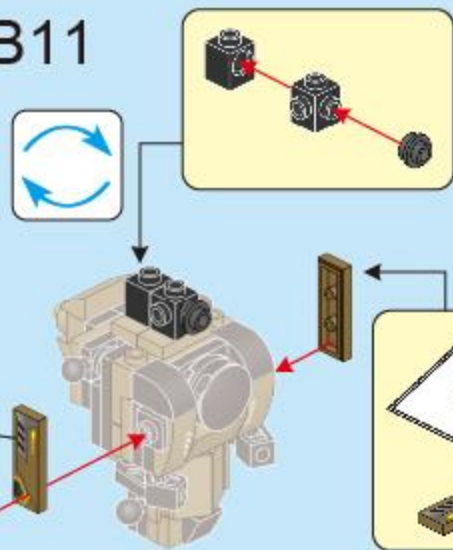

B12

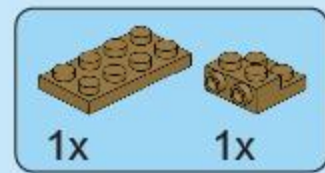
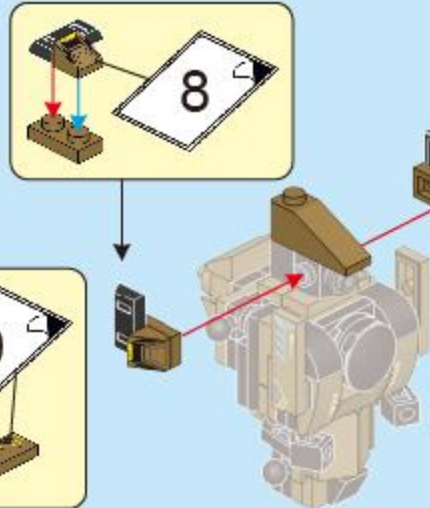

B13

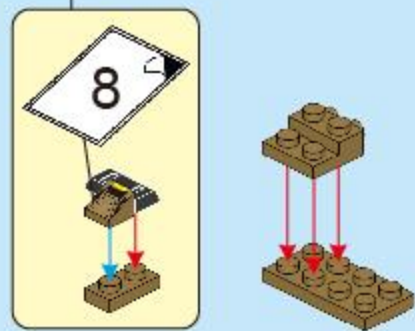



B14

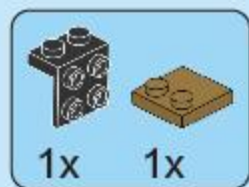

B15

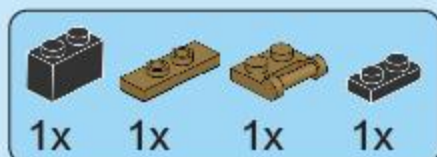

B16



B17



B18

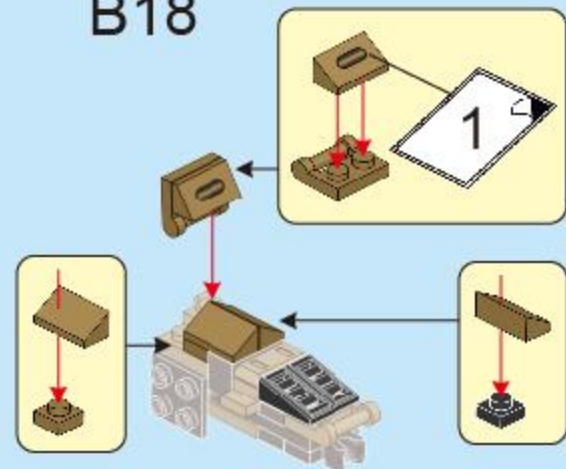
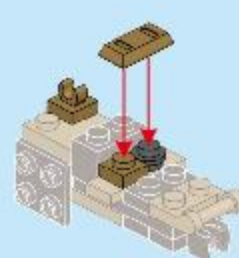
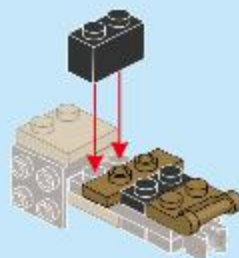
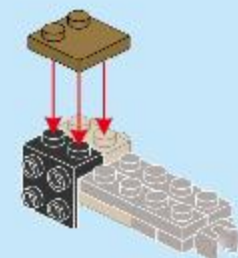
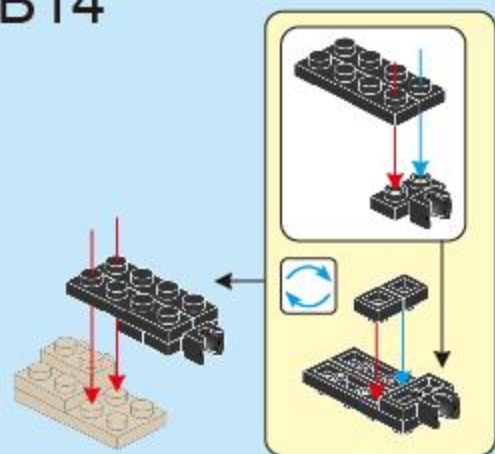

B19

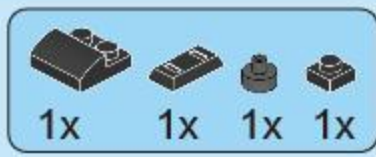

B20

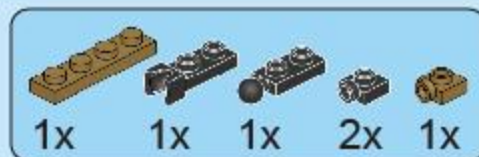

B21

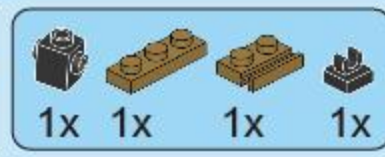

B22



B23

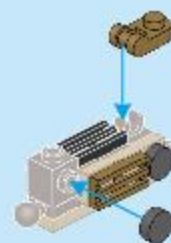
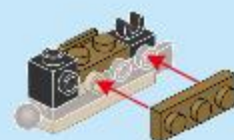
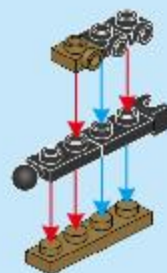
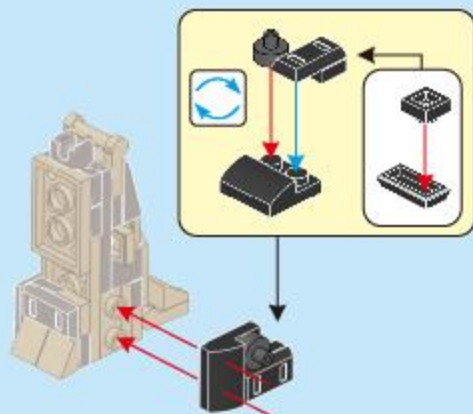
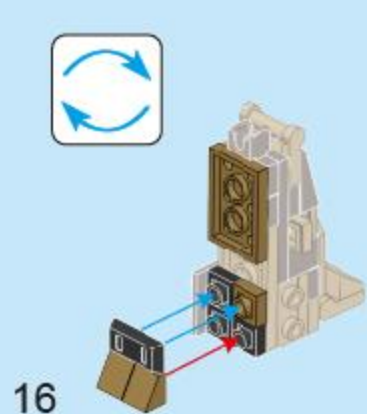



B24

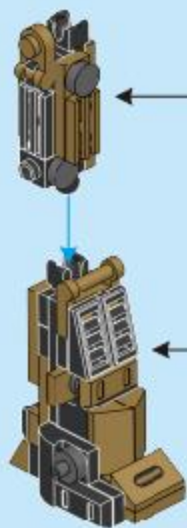

B23



B20

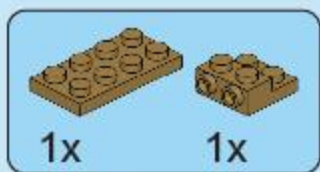

B25

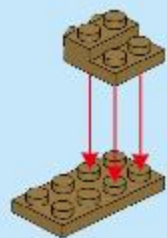

B26

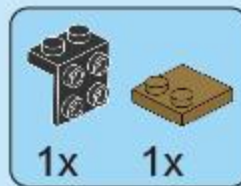
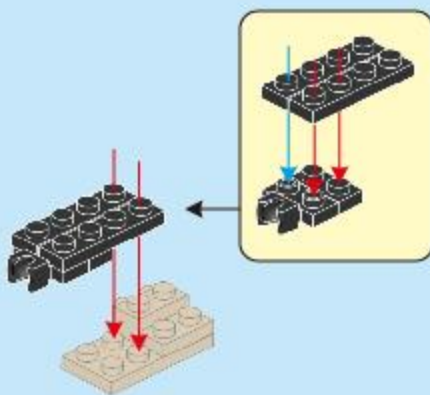

B27

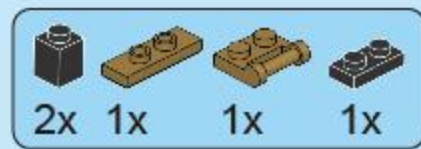

B28

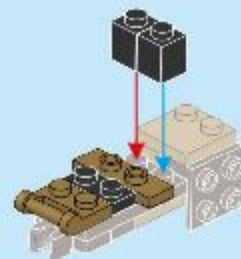

B29

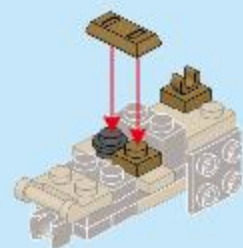

B30

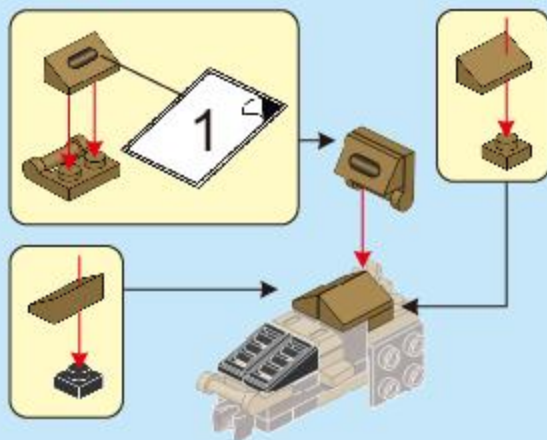

B31

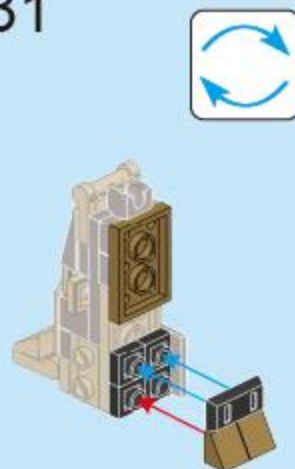

B32

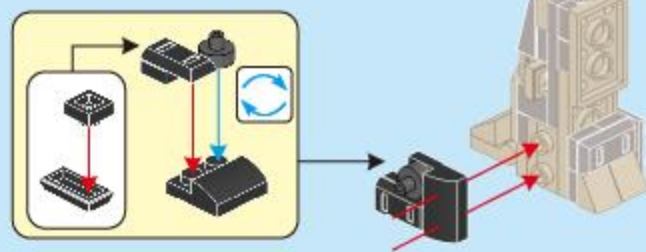

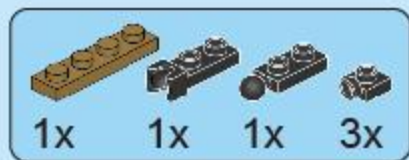

B33

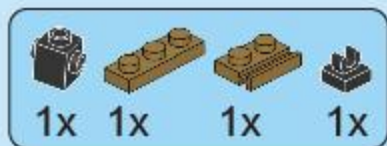
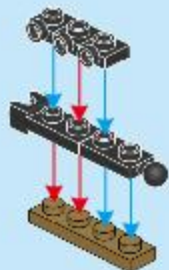

B34

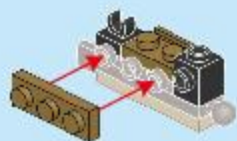

B35

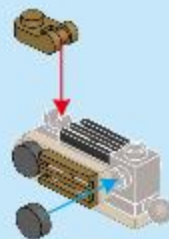

B36

B35



B32

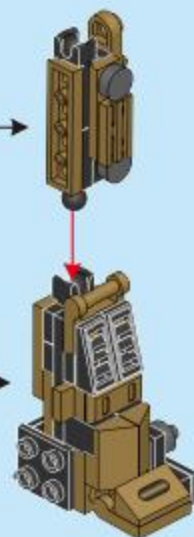

B37

B12

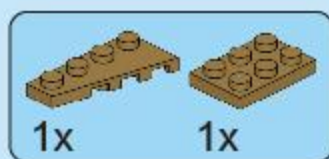
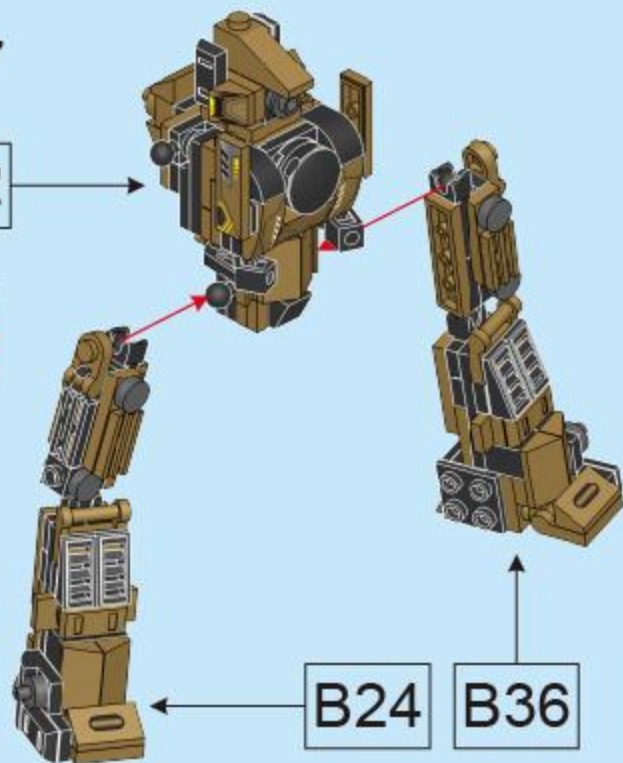

B38

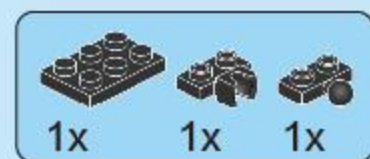
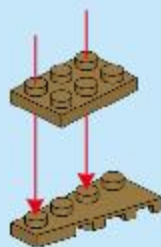

B39

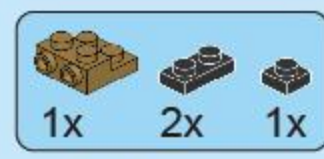
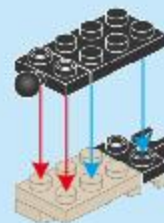

B40



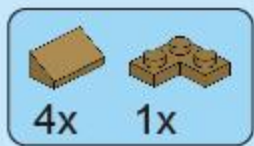

B41

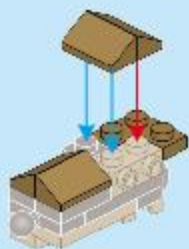

B42

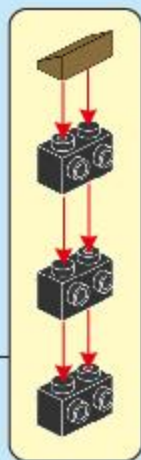
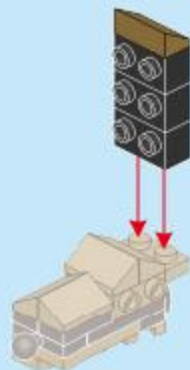

B43

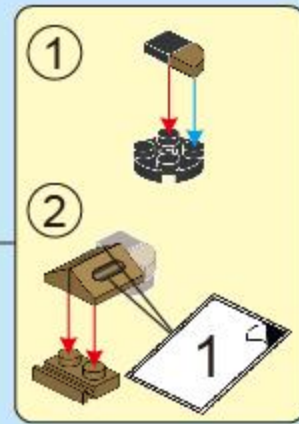

B44

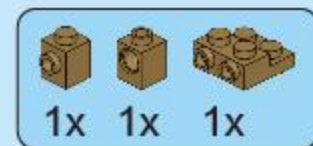
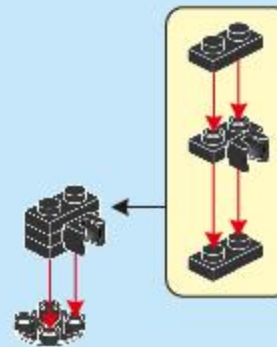

B45

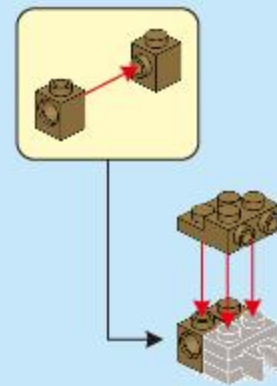

B46

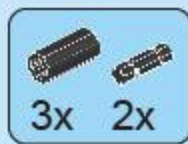
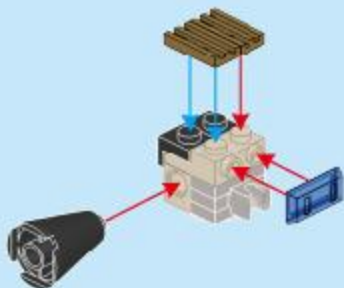

B47

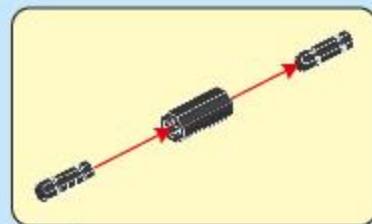

B48



B49



B50



B46

B43

B49

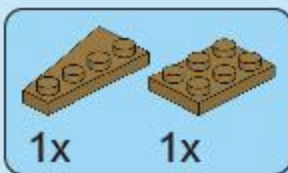

B51



B52

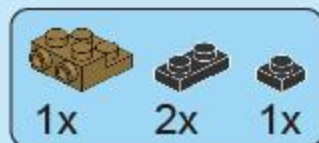

B53

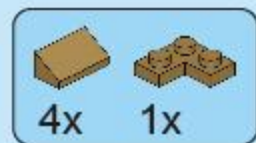

B54

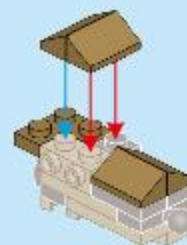
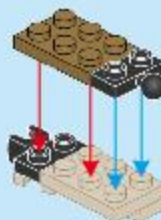
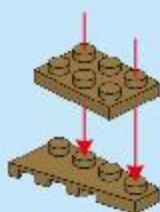
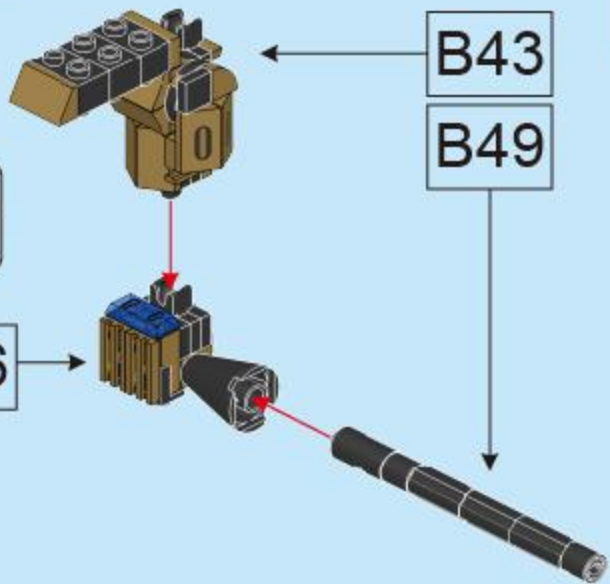

B55

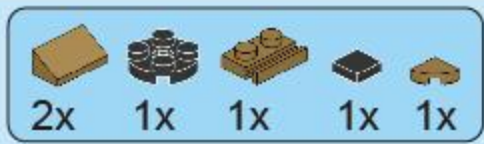
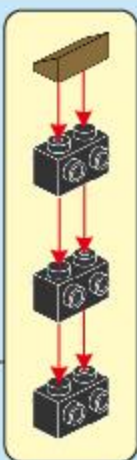

B56

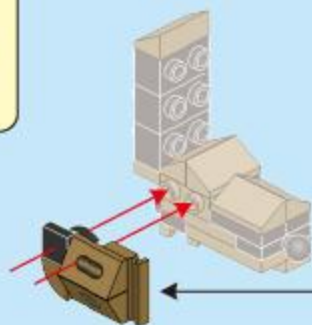

B57

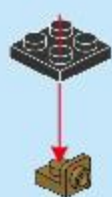

B58

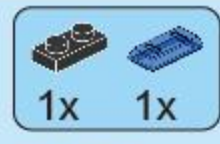

B59

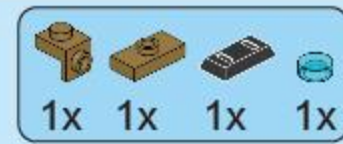

B60

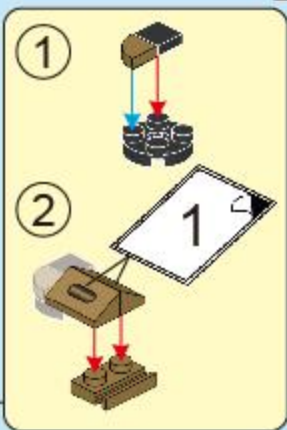
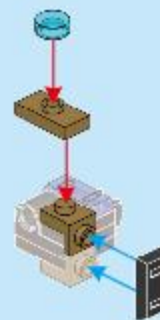



B61

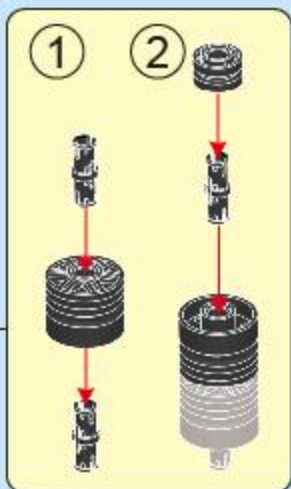
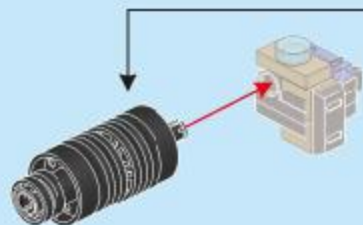

B63



B37

B62

B

B62



B56



B61



B50

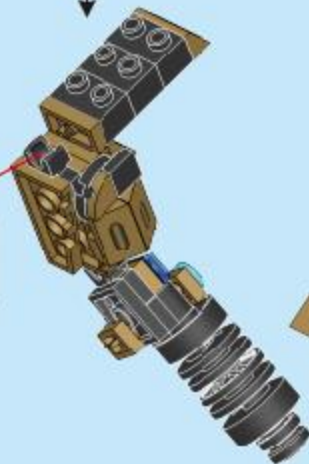
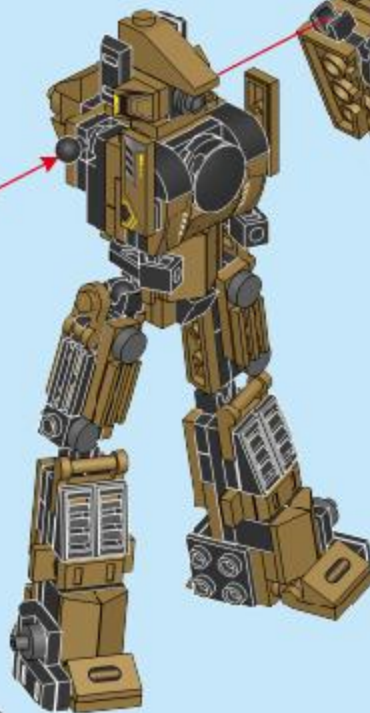

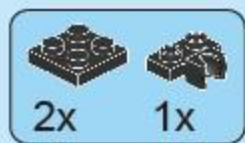

C1

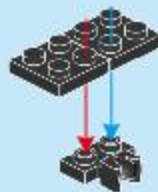

C2

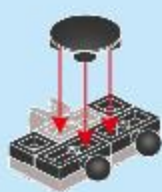

C3

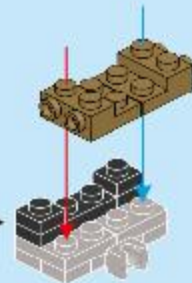

C4



C5

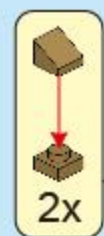

C6

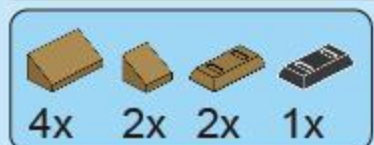

C7

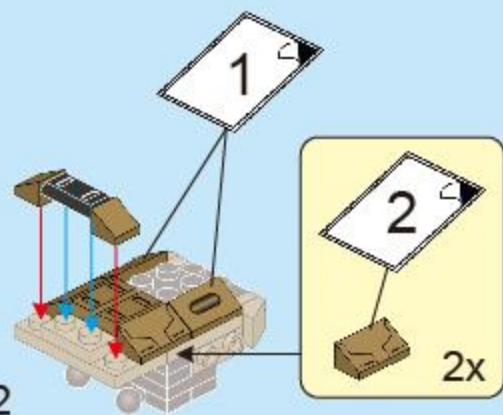

22



C8

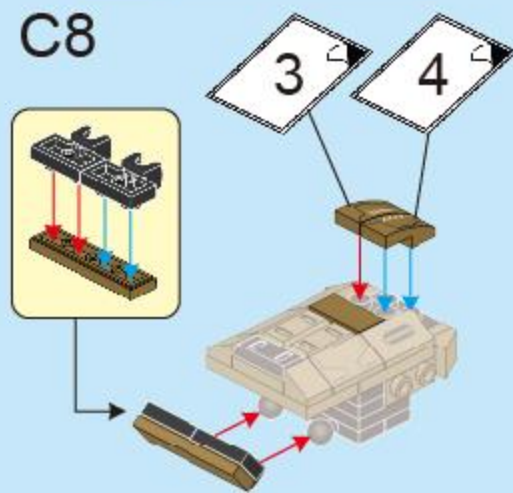

C9

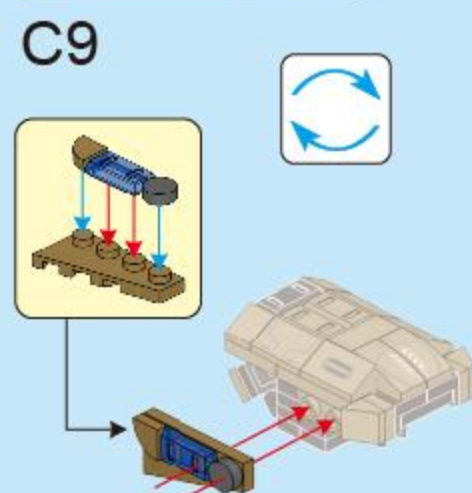

C10

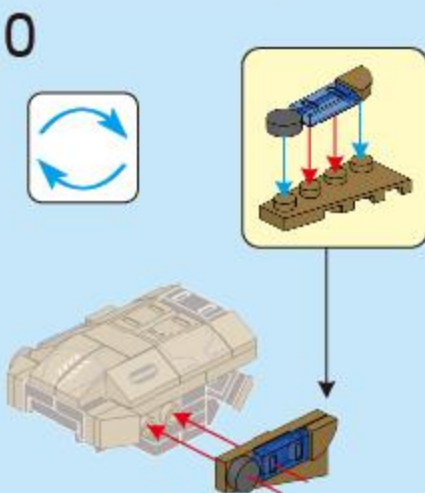

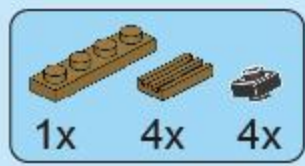

C11

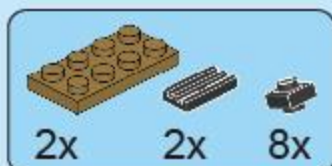
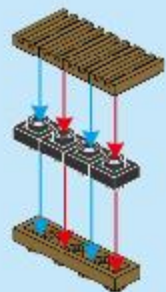

C12

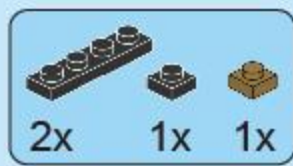
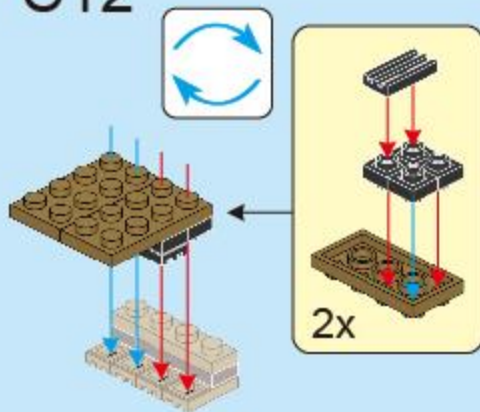

C13

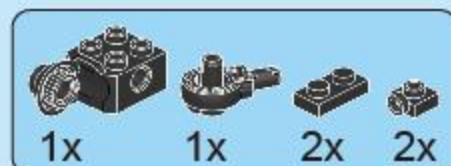
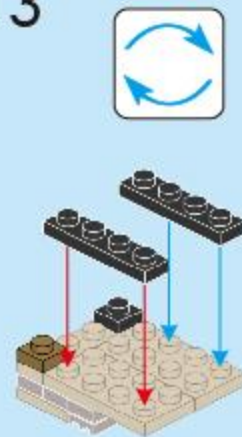

C14

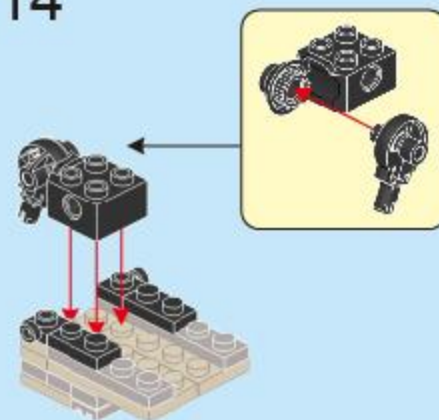

C15

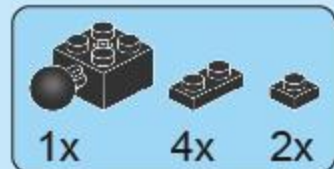
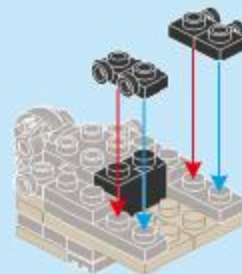

C16

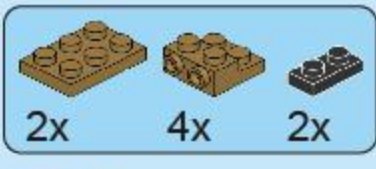
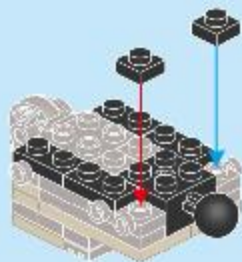

C17

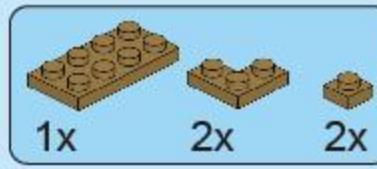
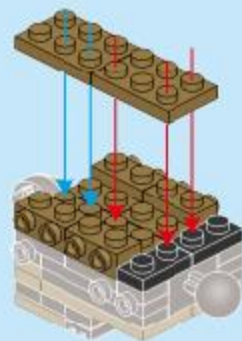

C18

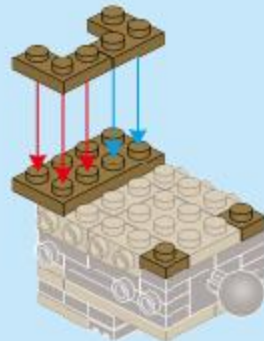

C19

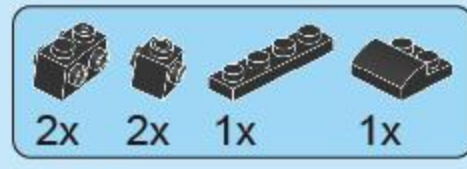

C20

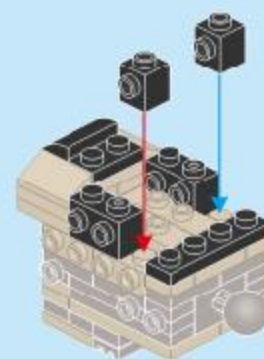

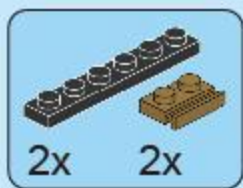

C21



C22

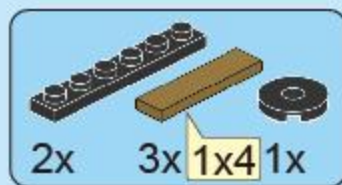

C23



C24

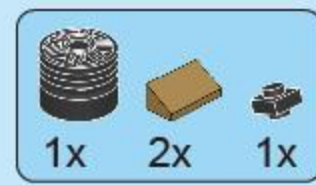

C25

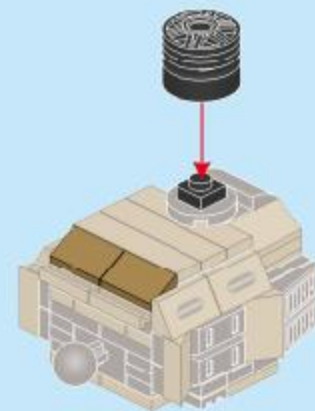
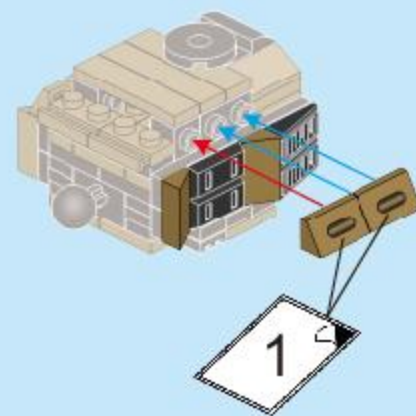
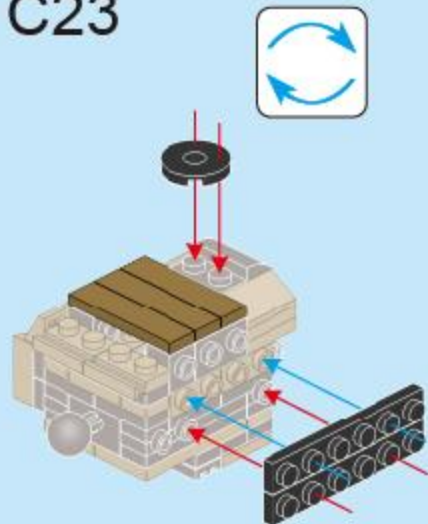
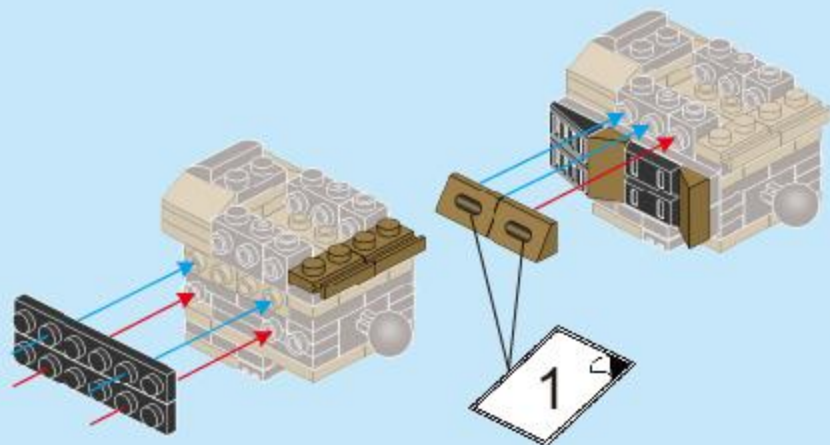

C26



C27



C28



C29



C30



C31

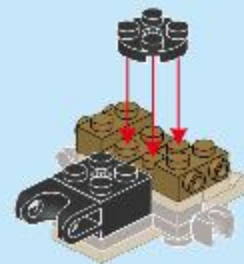
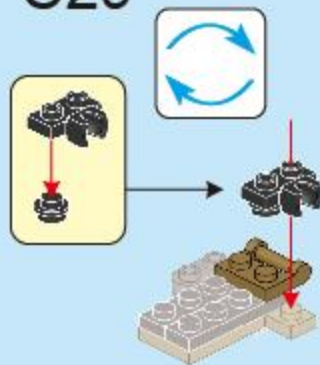
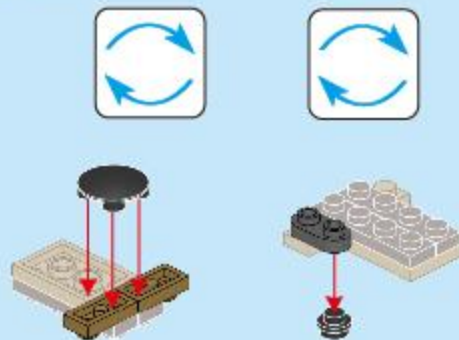



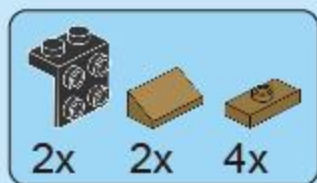

C32

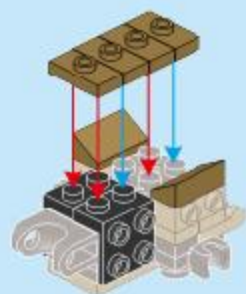

C33

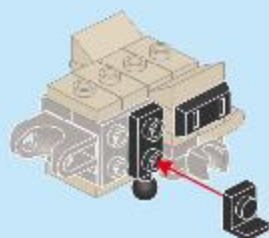

C34

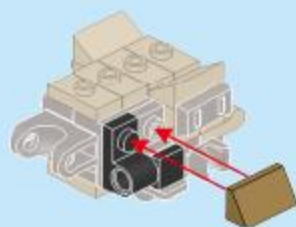

C35

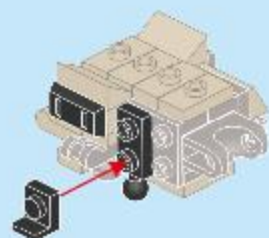

C36

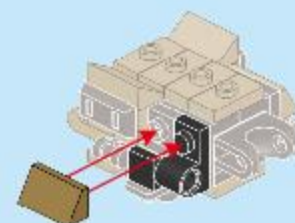

C37

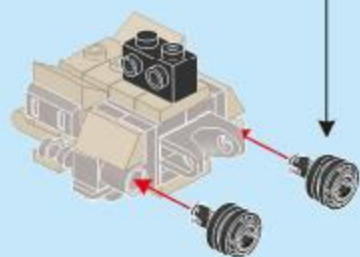

C38

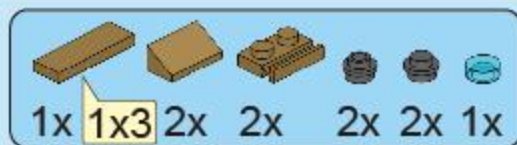
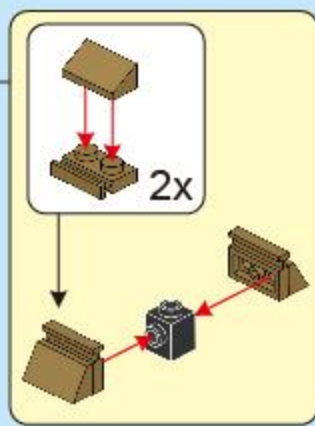
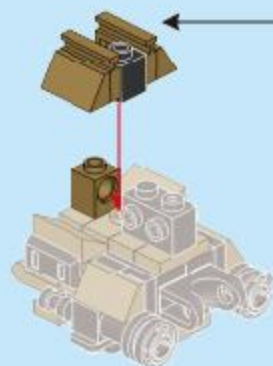

C39

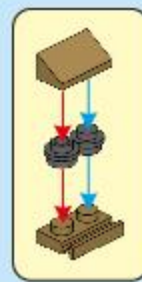

5

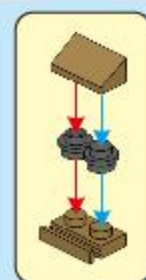
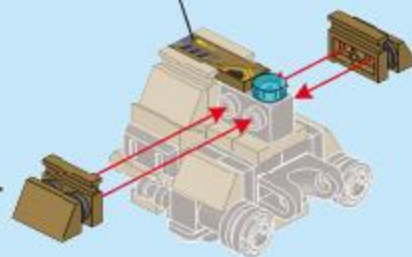



C40

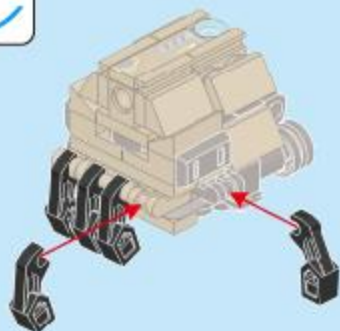

C41

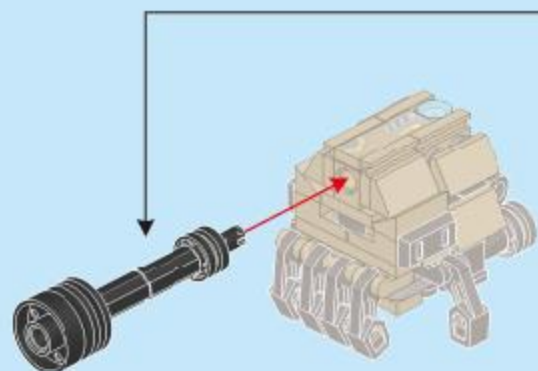
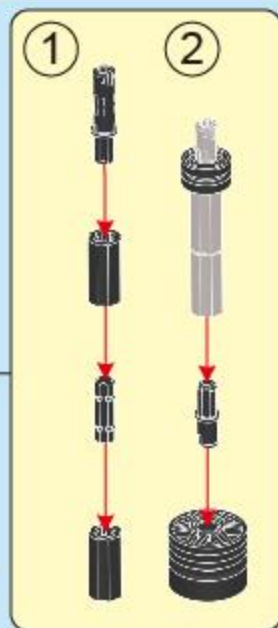

C42

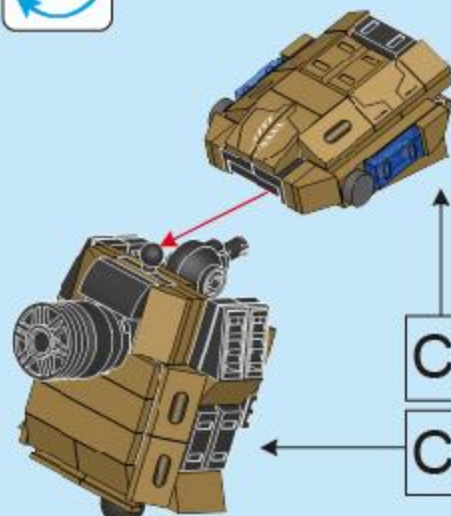

C10

C25



C41

C



FC1037

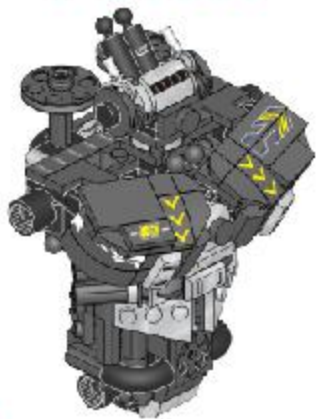

FC1040

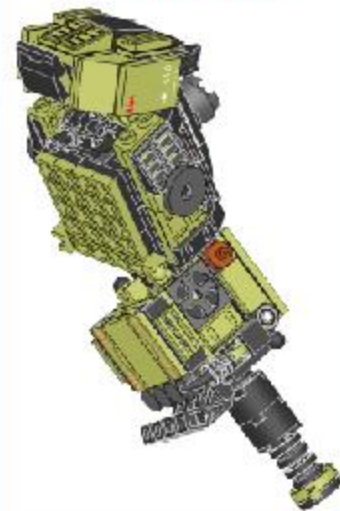

FC1036



FC1038

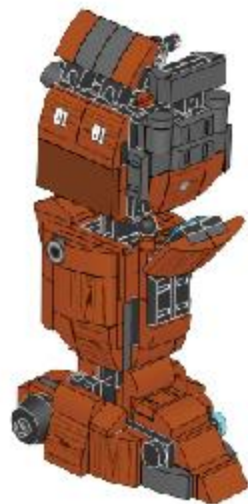

FC1039

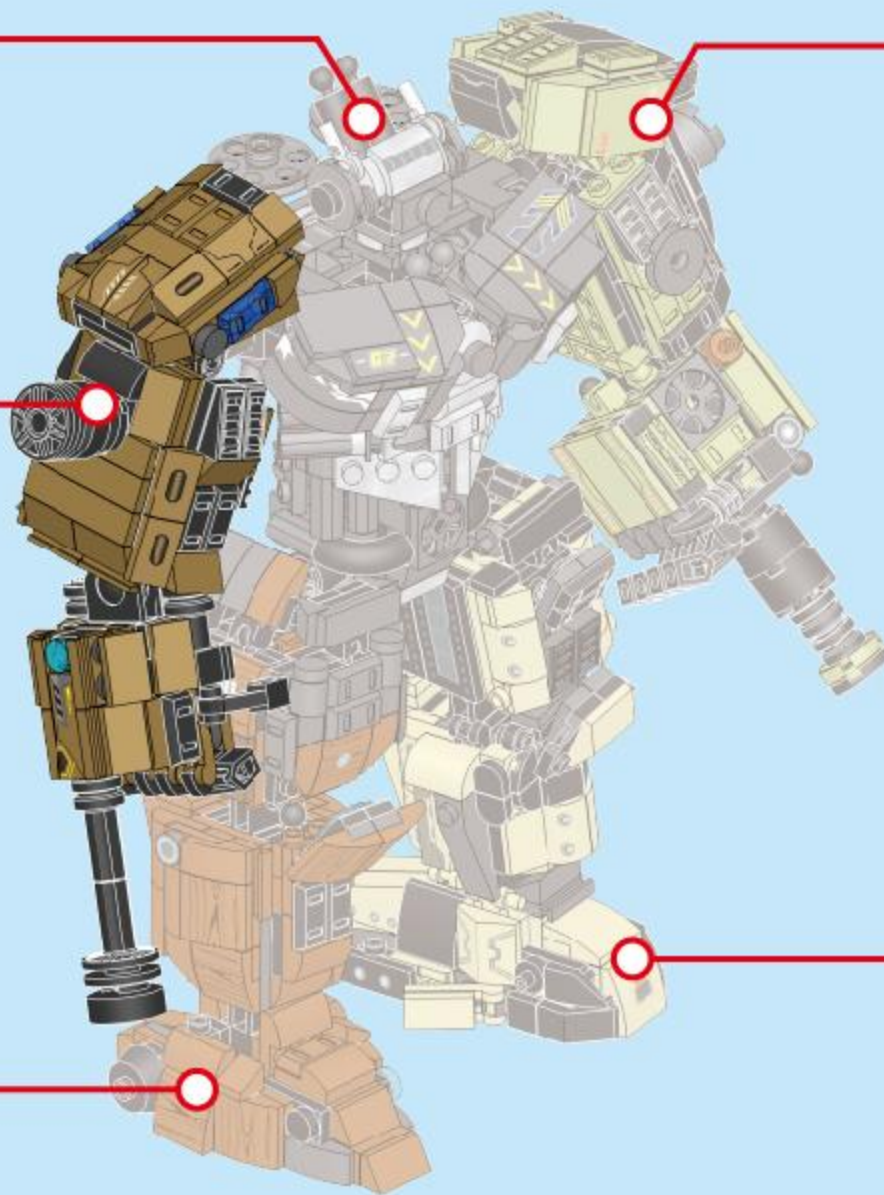
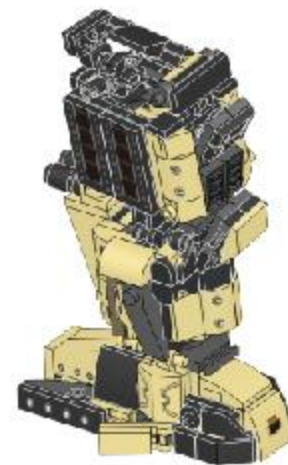

**2 IN 1**  
TRANSFORMS



**COLLECT 5 MODELS**  
TO COMBINE RELOADED BERSERK