

FC4005



拆件器使用方法, 仅为示例

Usage of Brick Separator, Just for the sample

1

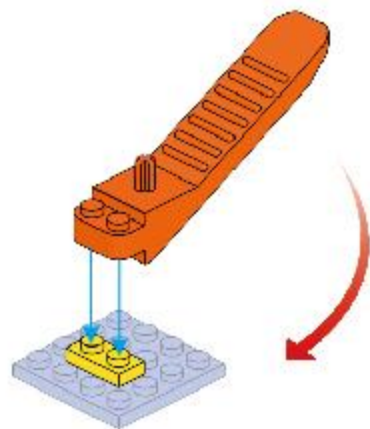

2

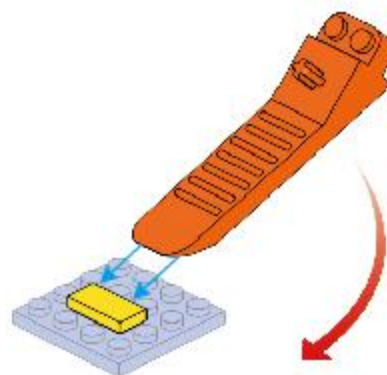

3

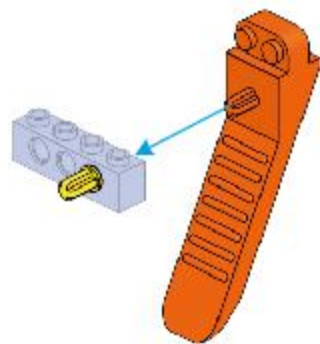

4

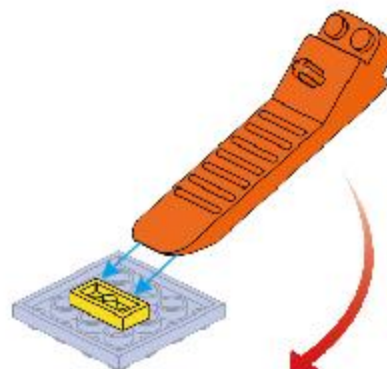

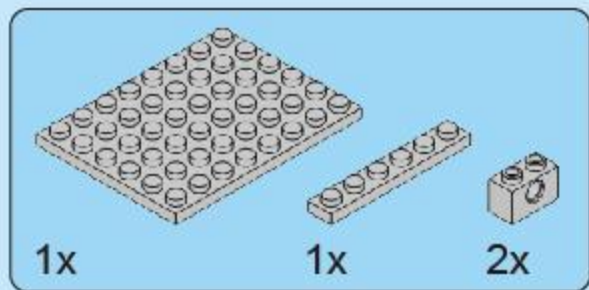

1

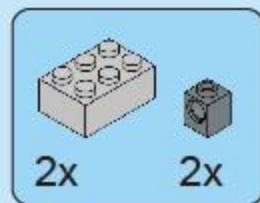
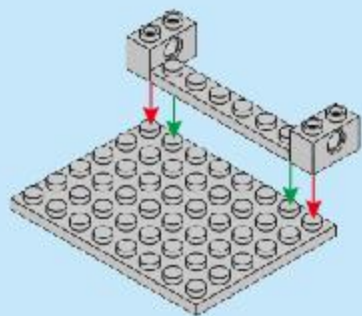

2

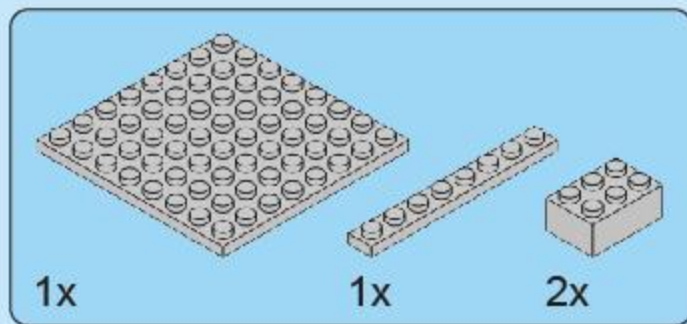
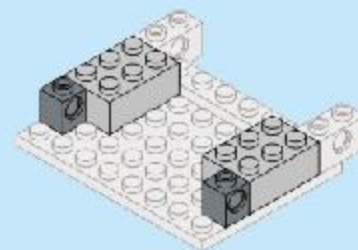

3

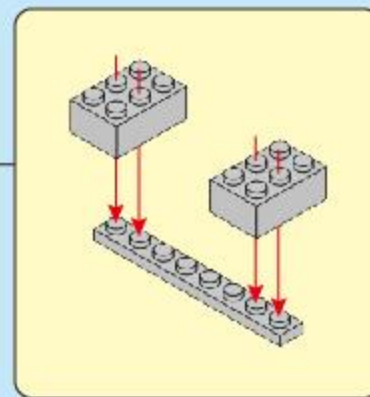
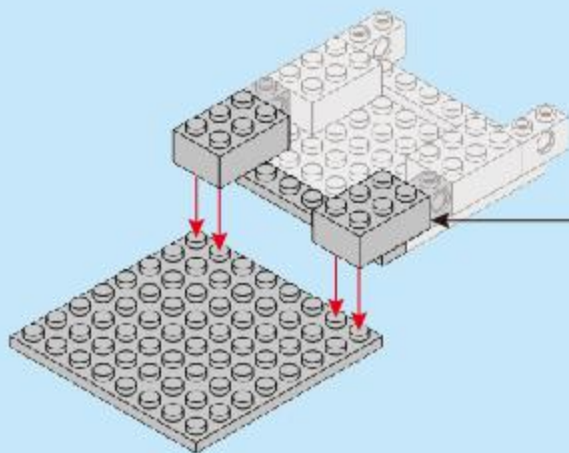

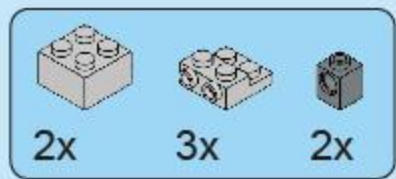

4

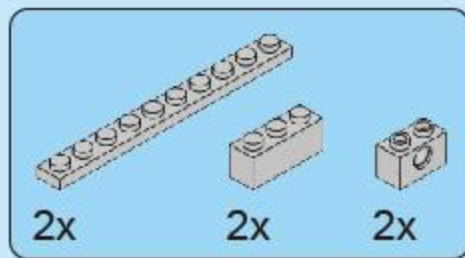
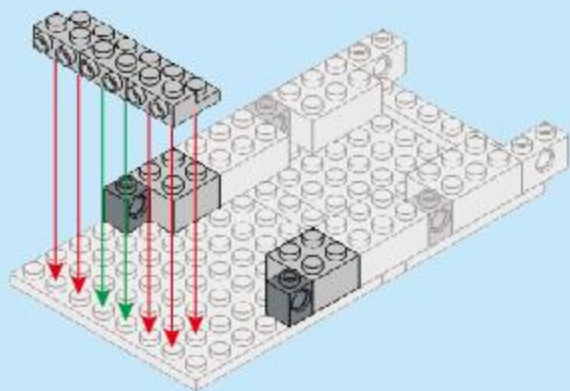

5

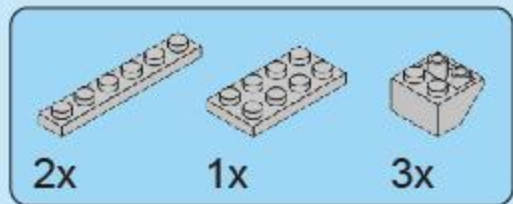
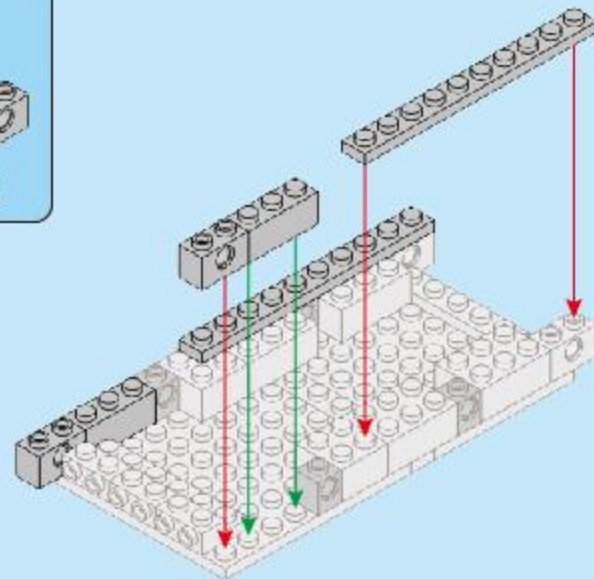

6

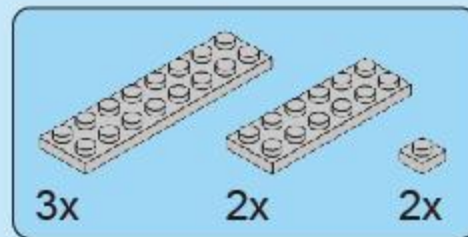
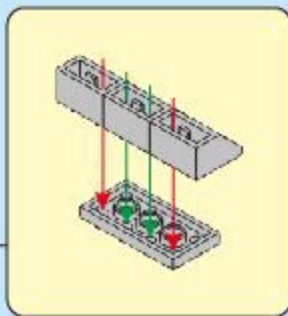
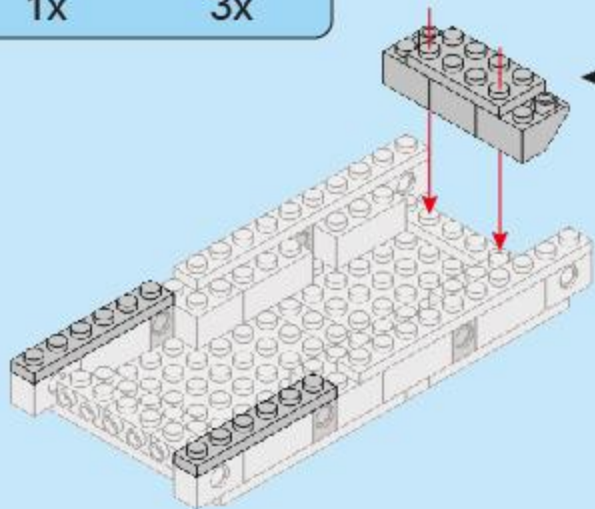

7

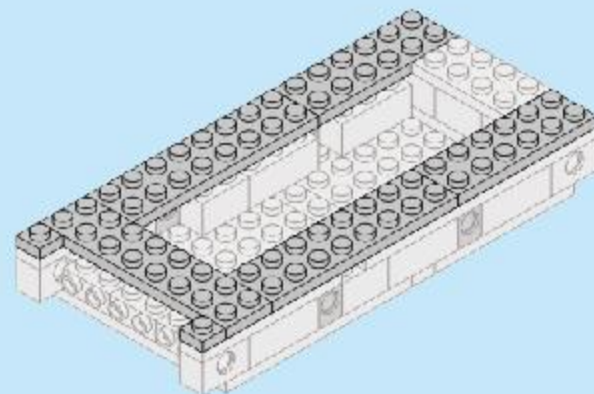

4

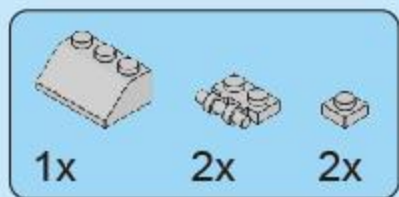

8

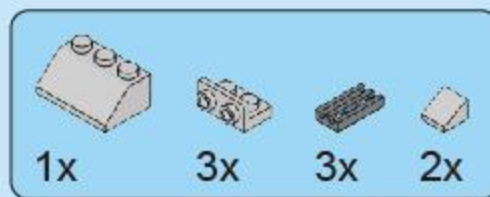
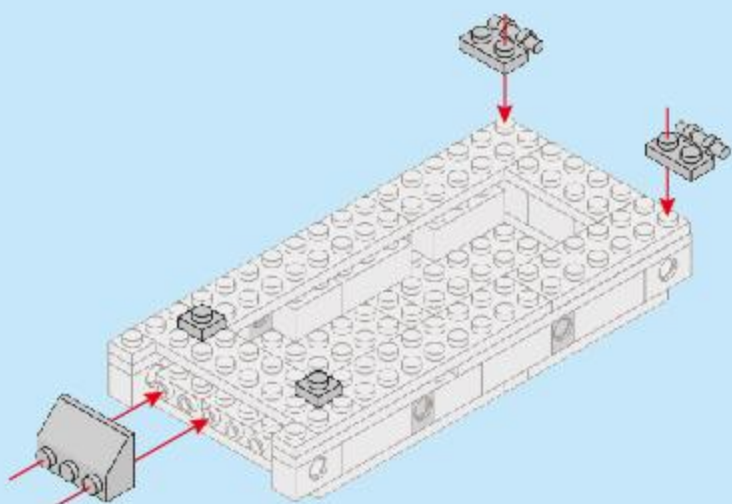

9

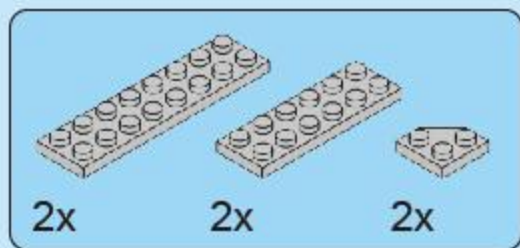
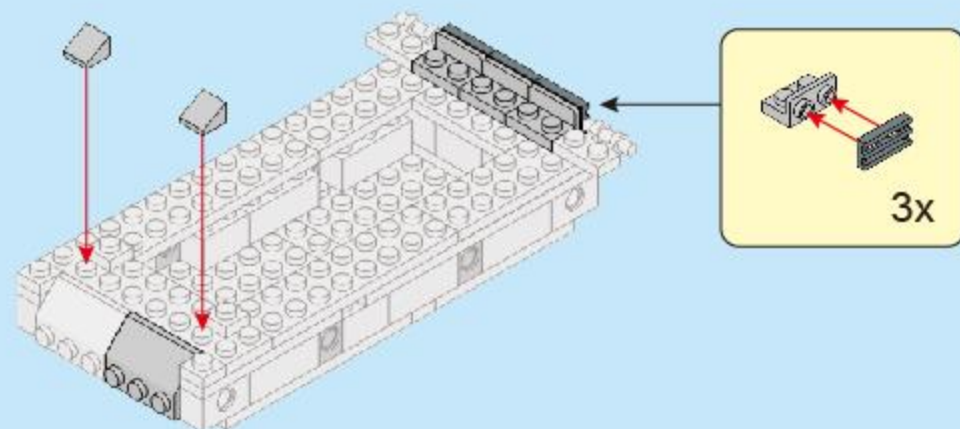

10

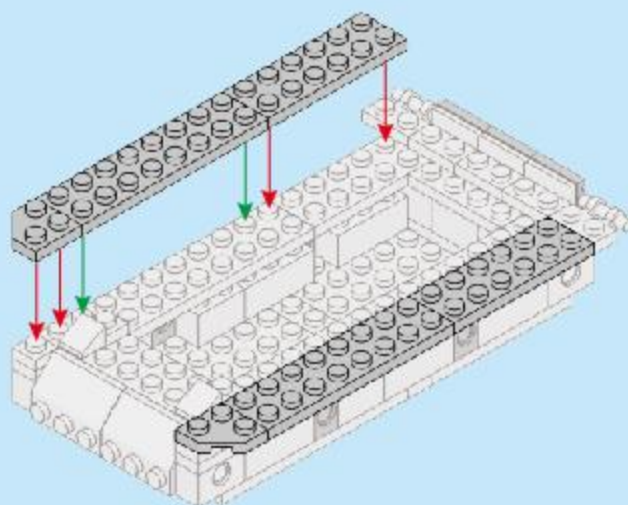

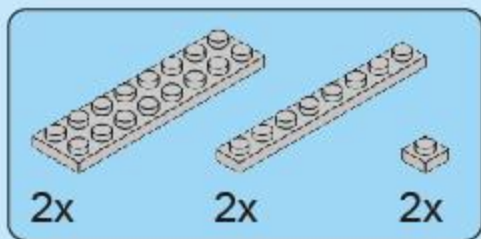

11

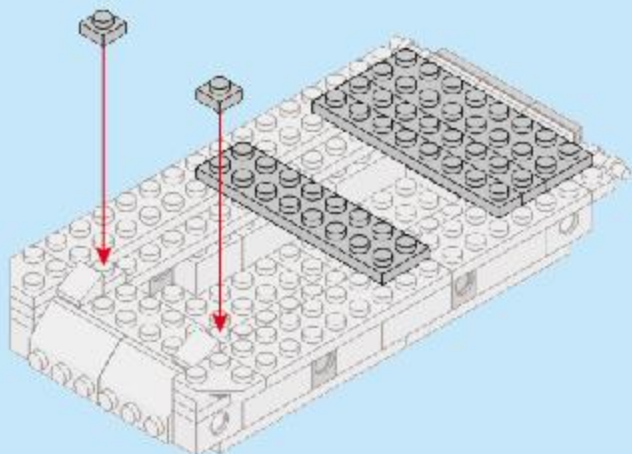

12

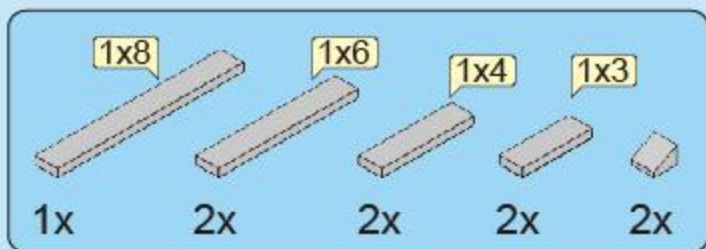
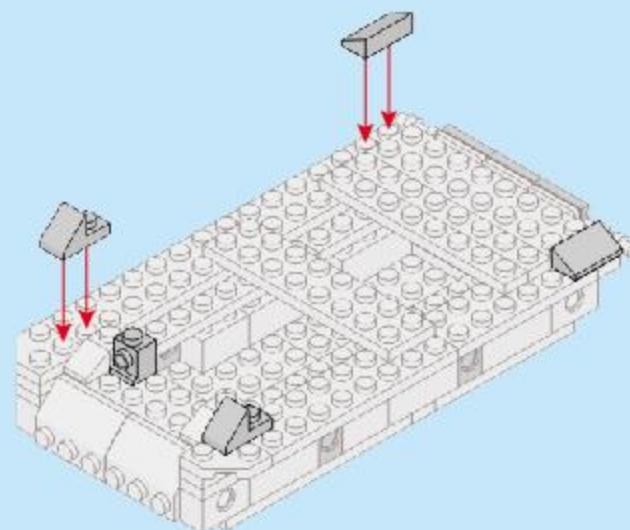

13

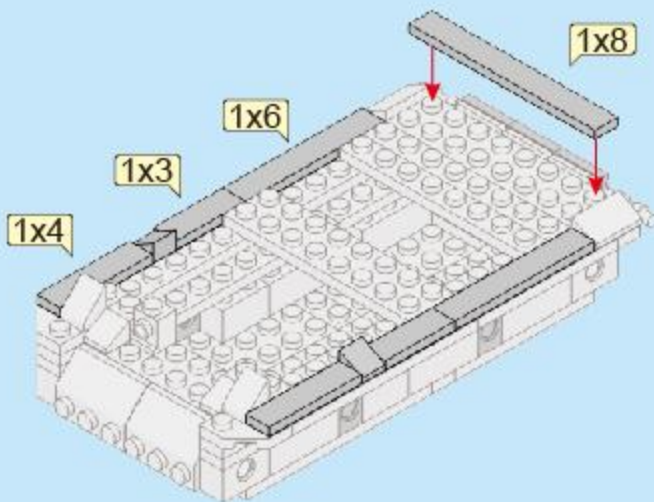

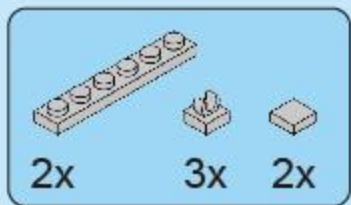

14

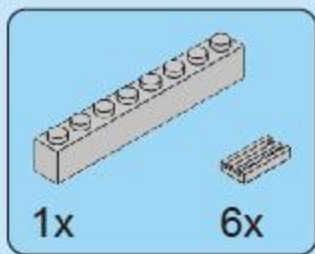
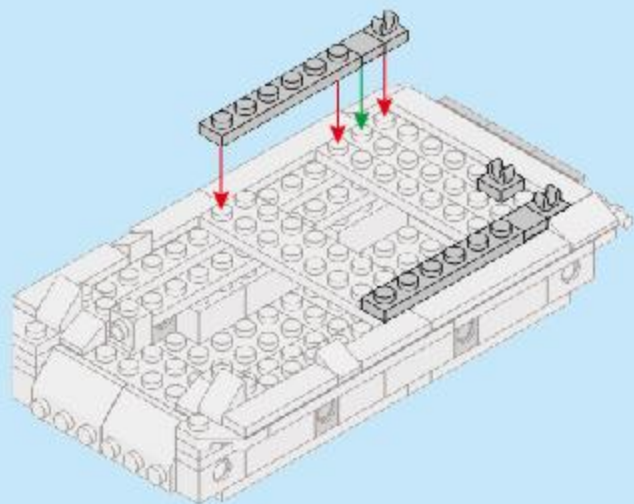

15

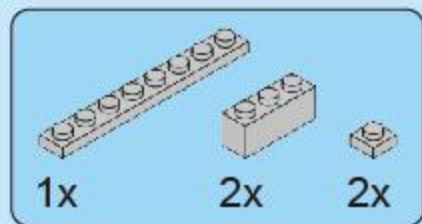
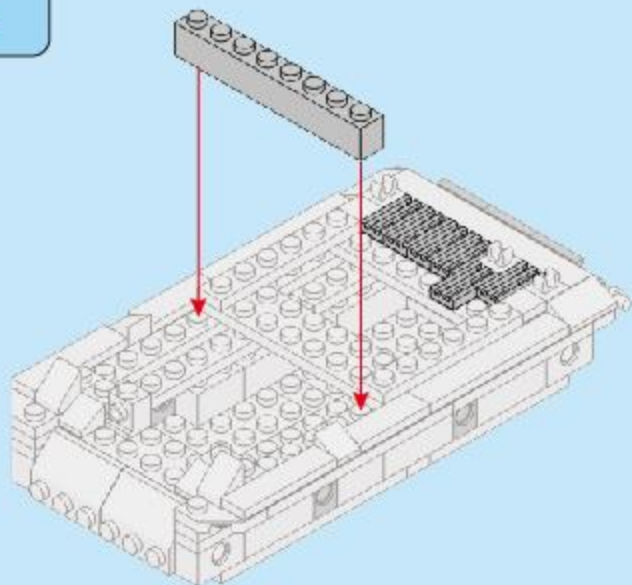

16

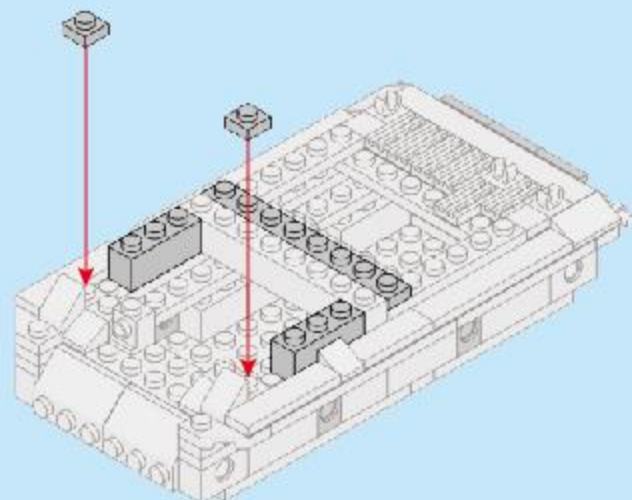

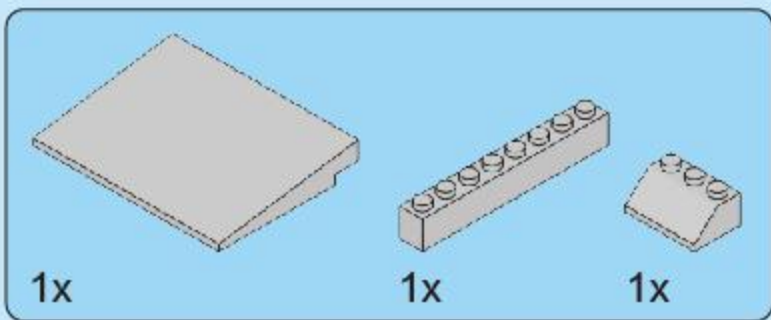

17

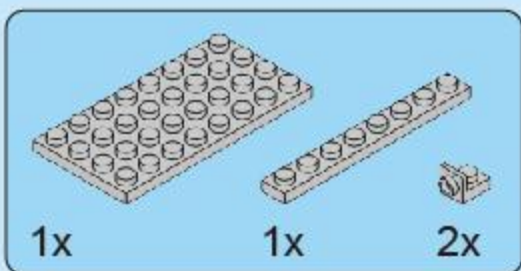
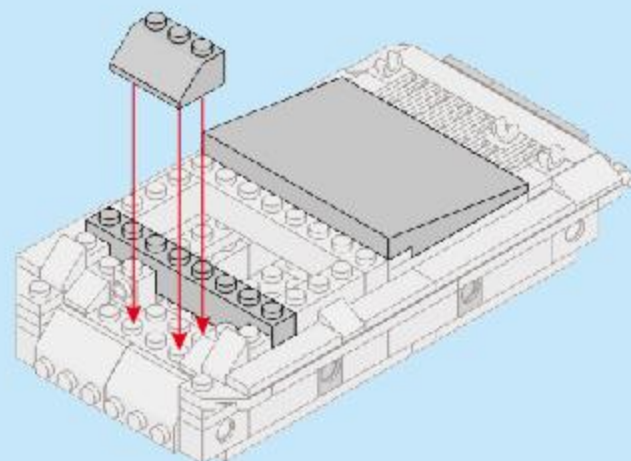

18

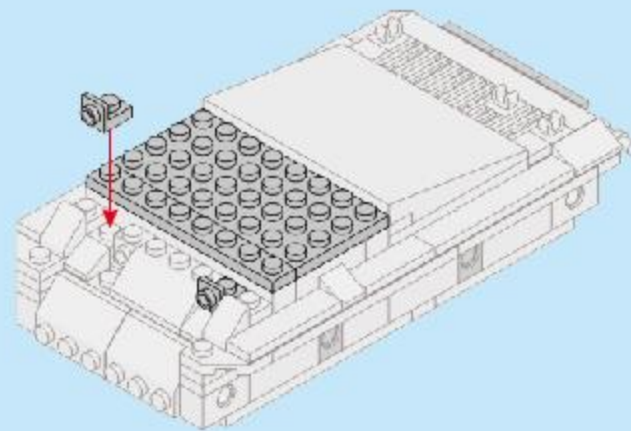



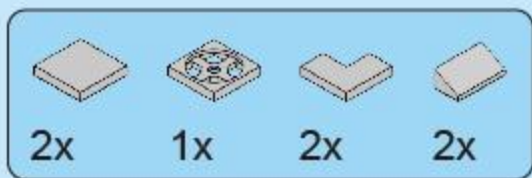

19

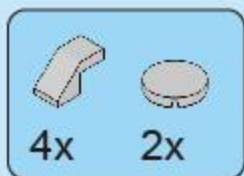
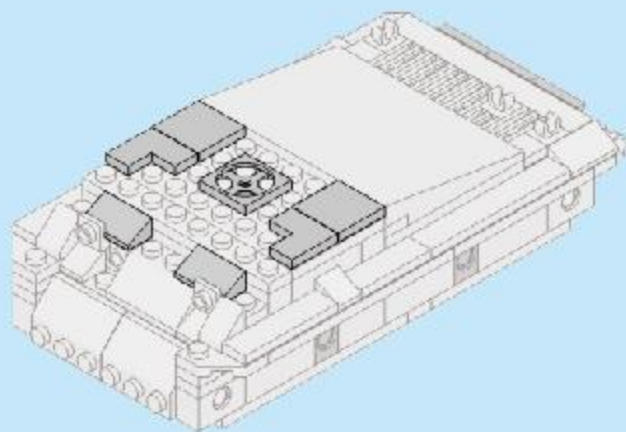

20

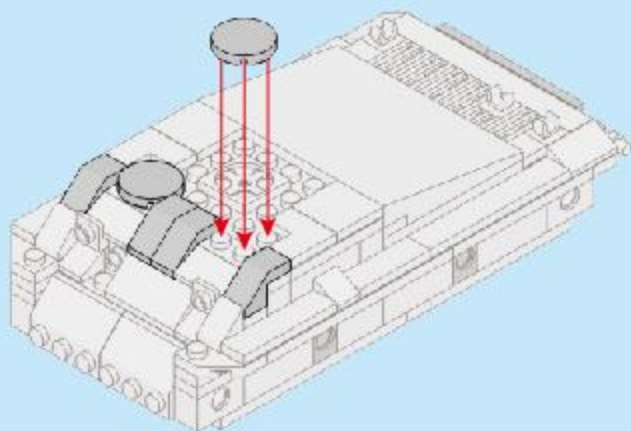

21

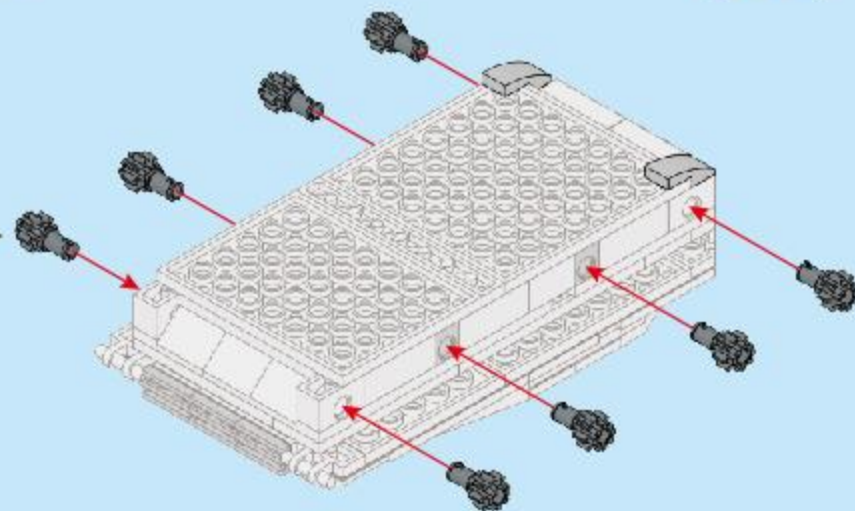
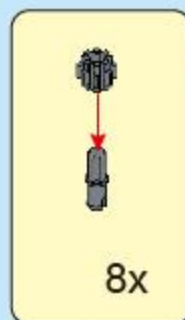



22

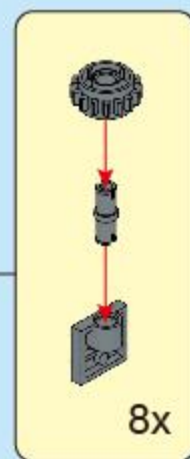
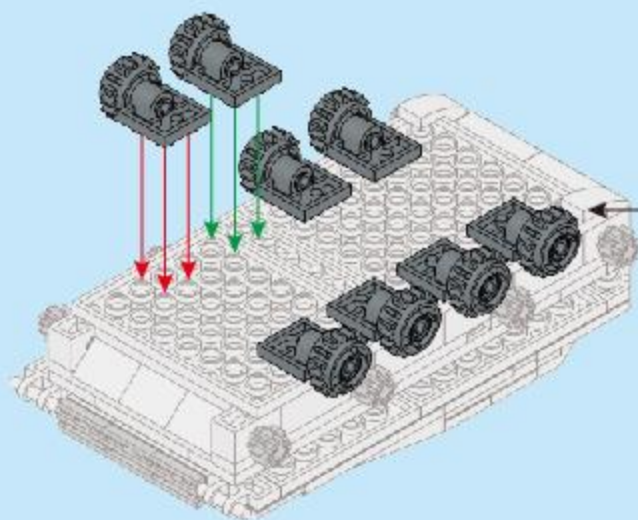

23

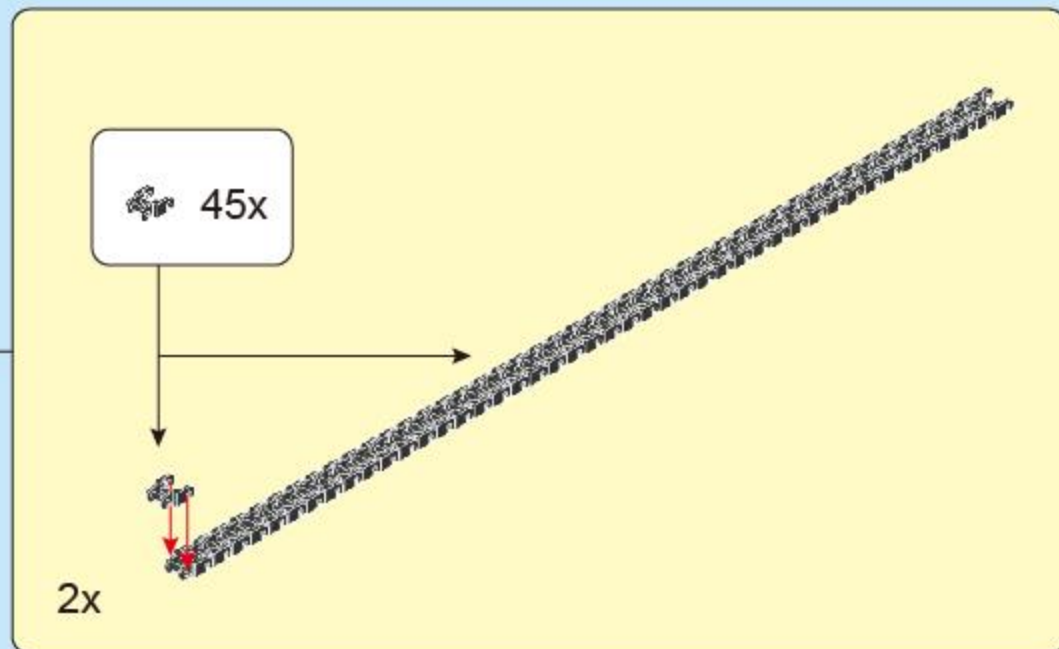
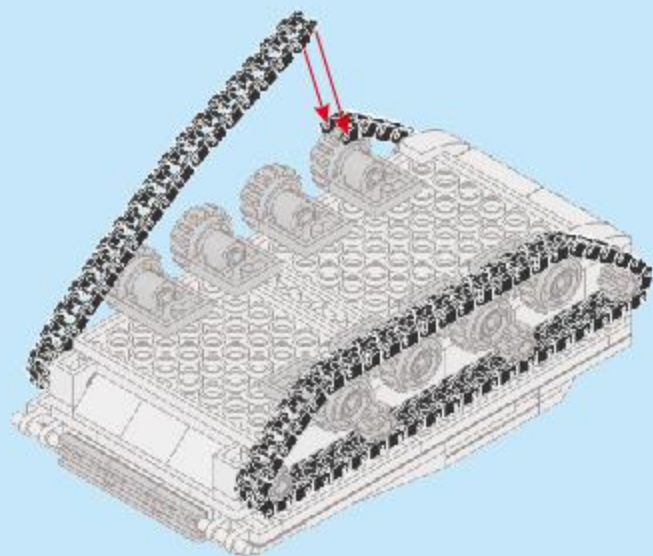



24

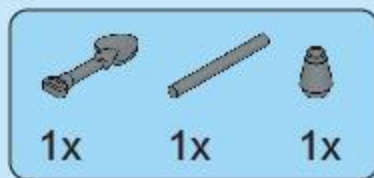
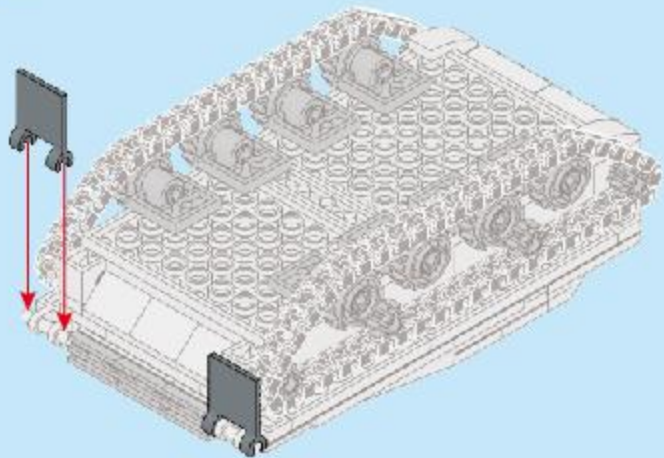

25

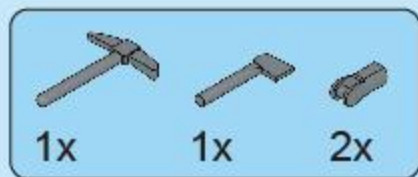
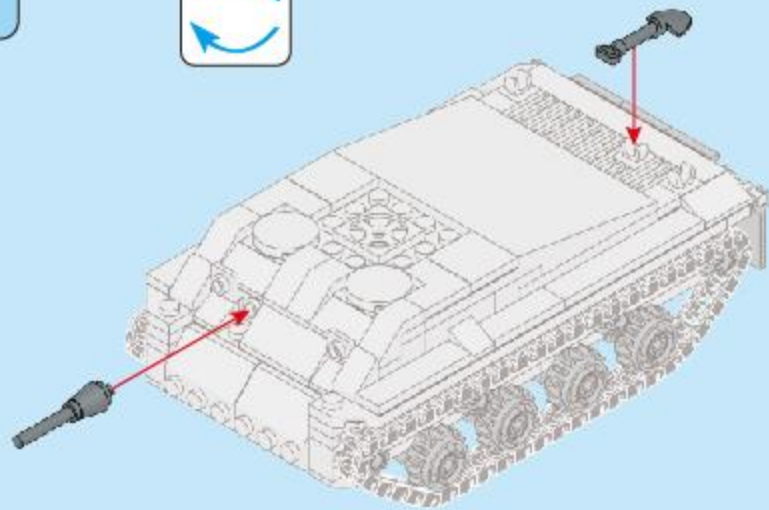
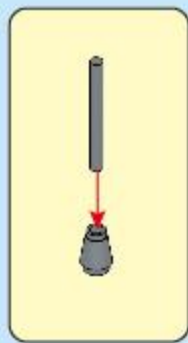

26

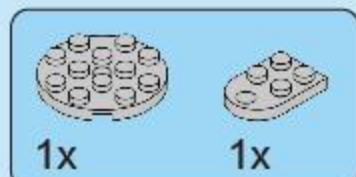
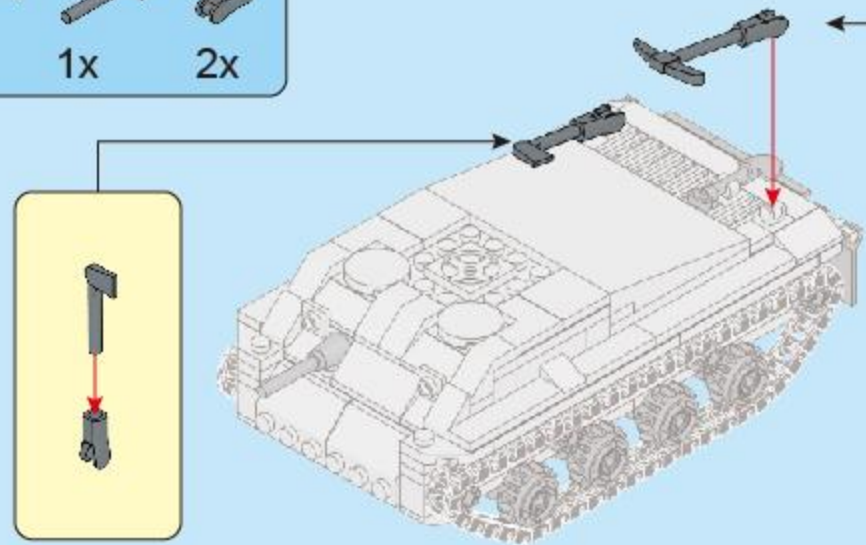

27



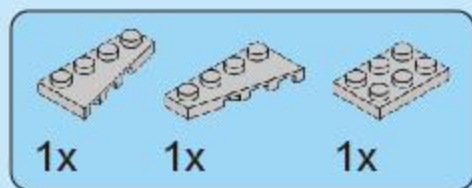

28

1x 1x 1x

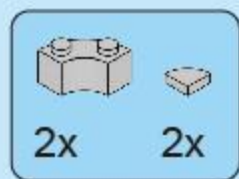
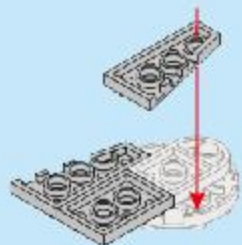

29

2x 2x

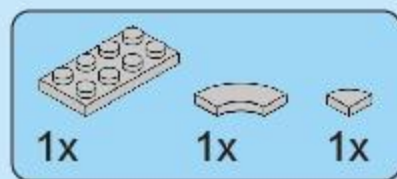
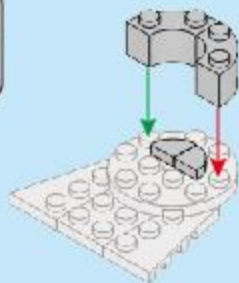

30

1x 1x 1x

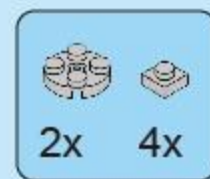
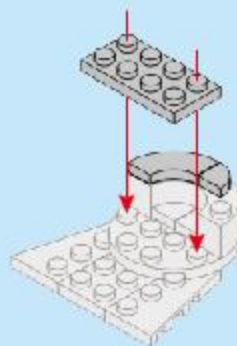

31

2x 4x

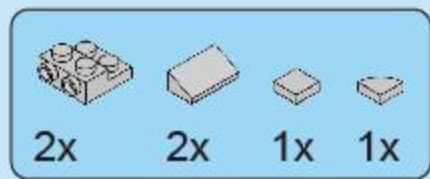
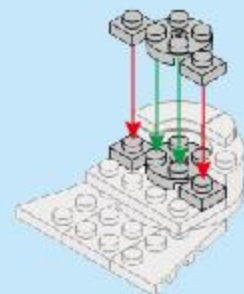

32

2x 2x 1x 1x

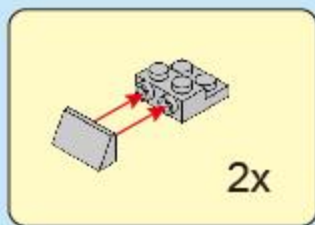

2x

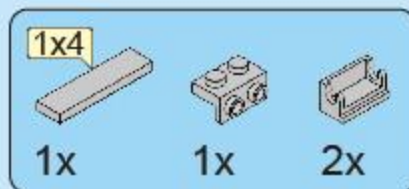
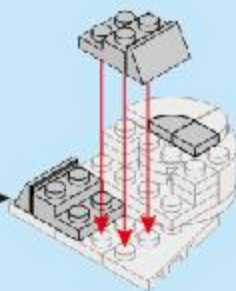

33

1x 1x 2x

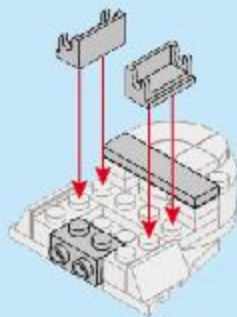

34

2x 1x

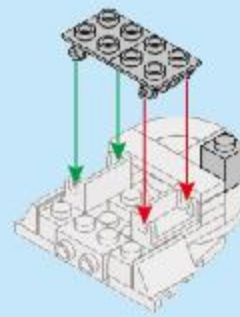



35

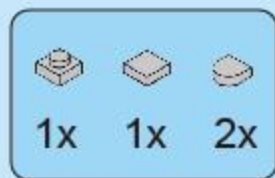
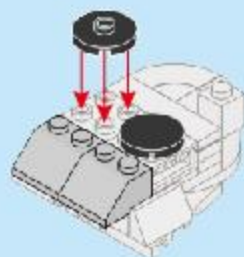

36

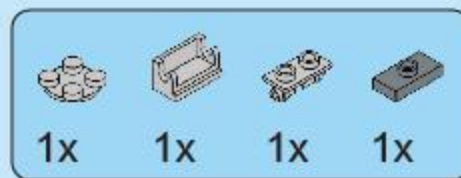

37

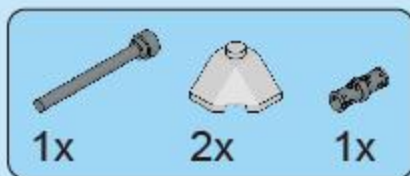
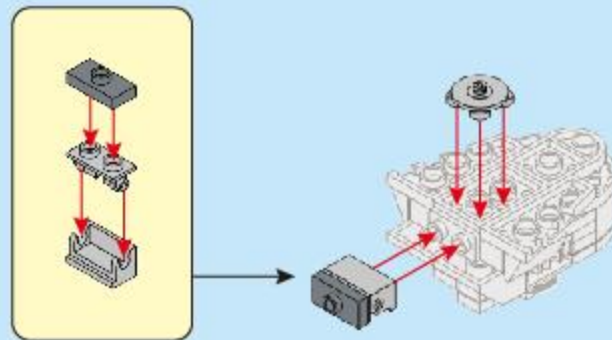

38

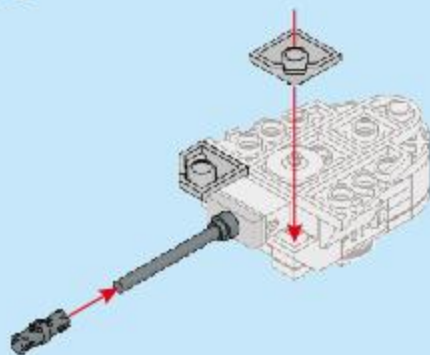

39

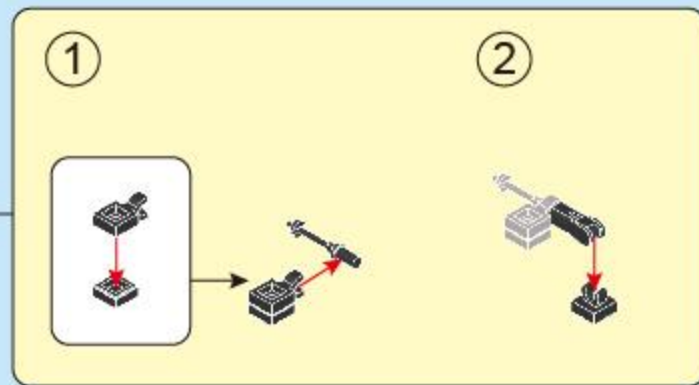
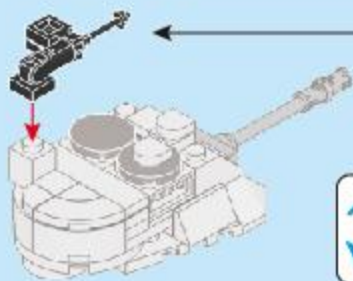

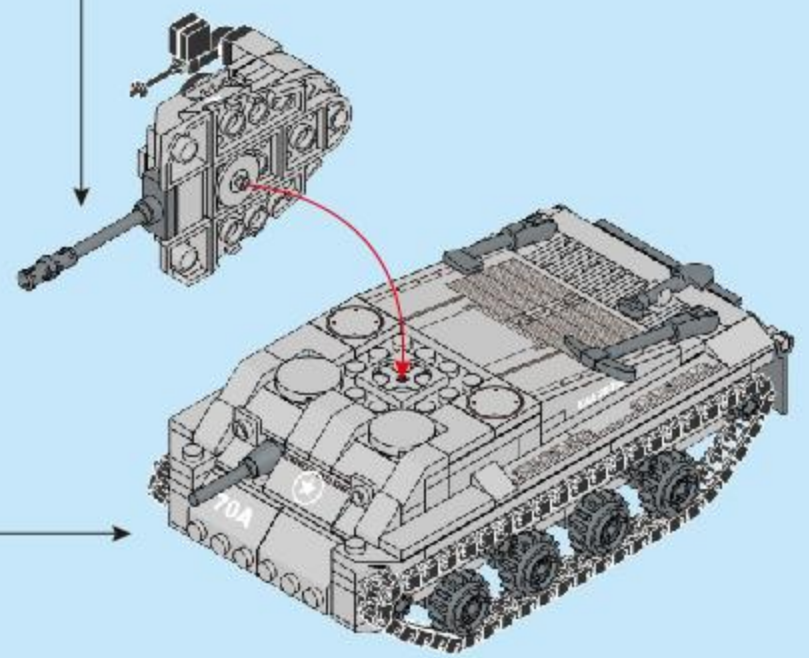
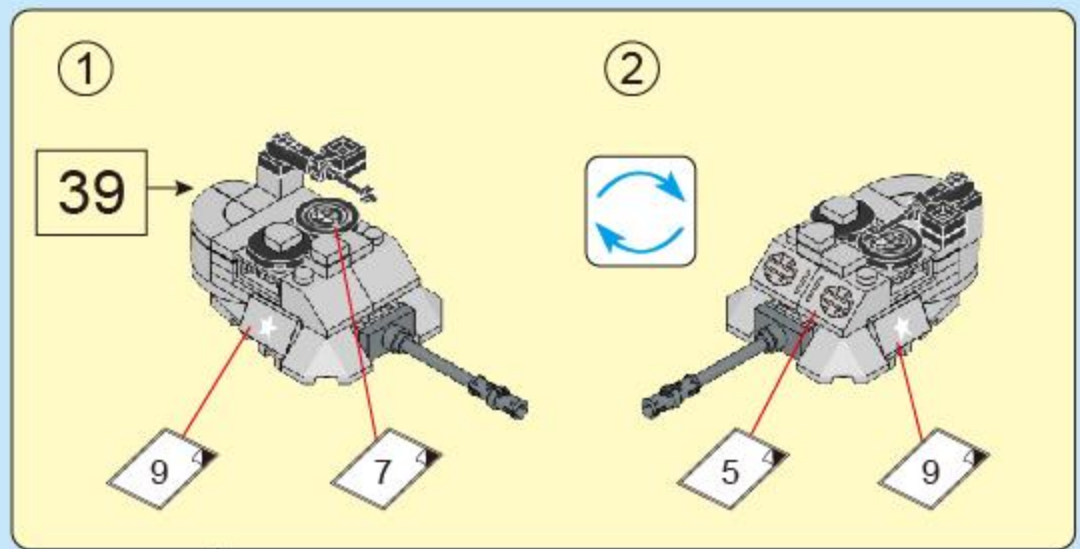
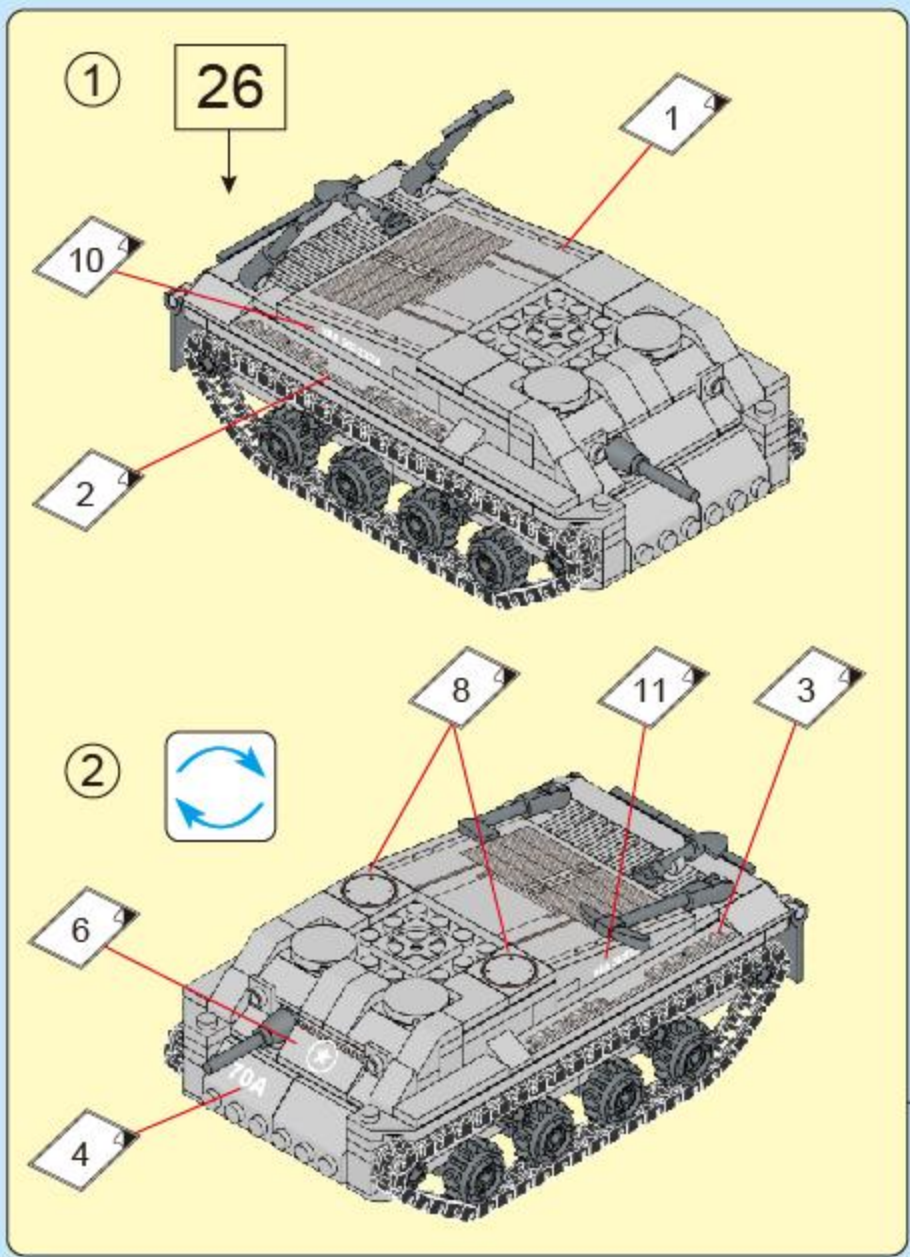



41

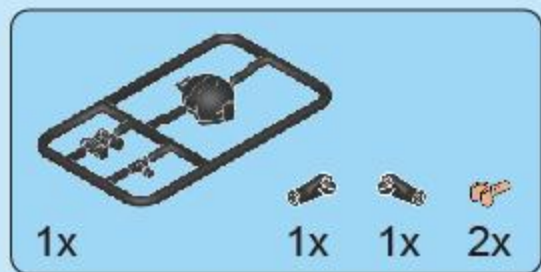
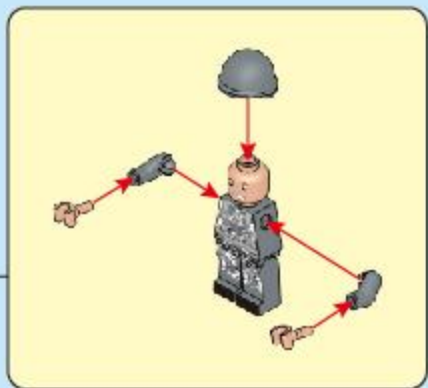

42

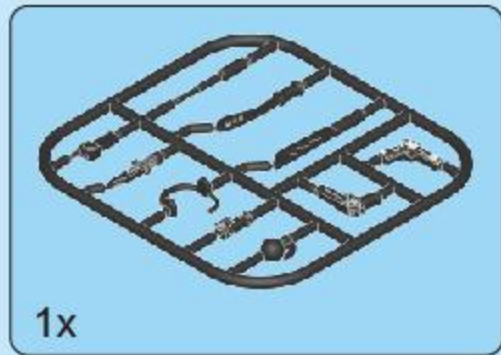
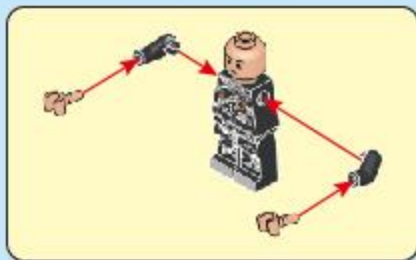

43

