

FC4006



拆件器使用方法, 仅为示例

Usage of Brick Separator, Just for the sample

1

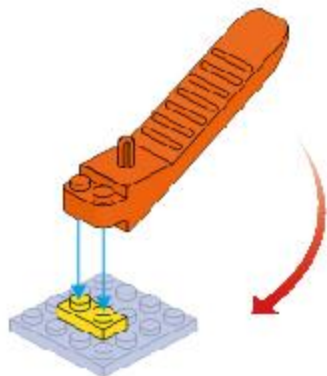

2

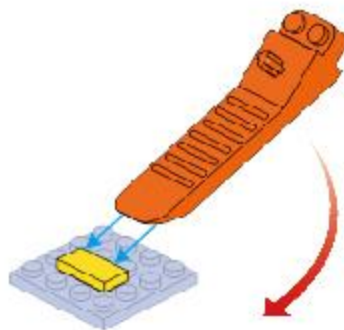

3

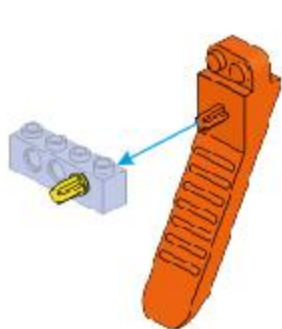

4

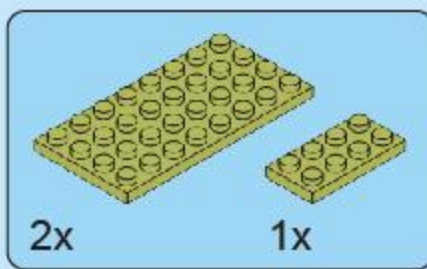
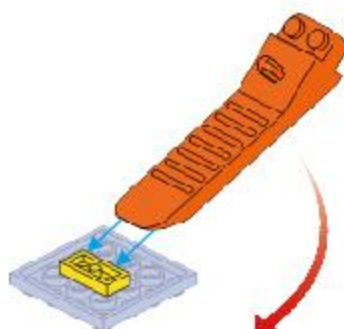

1

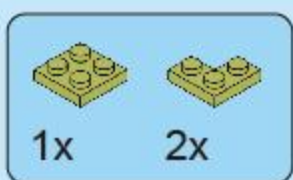
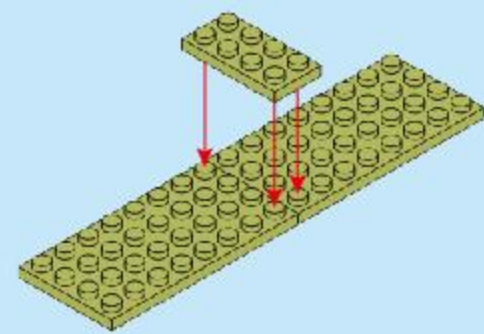

2

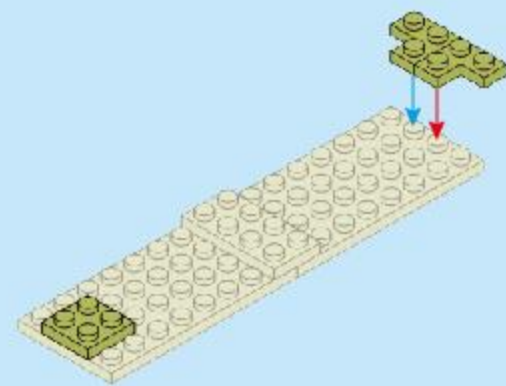



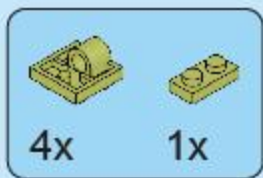

3

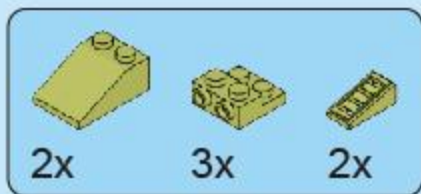
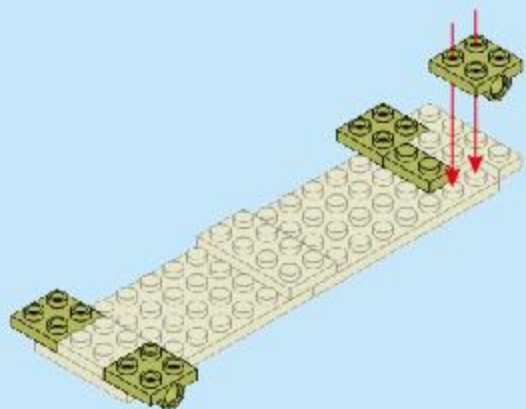

4

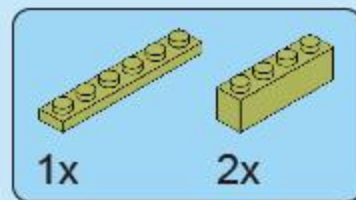
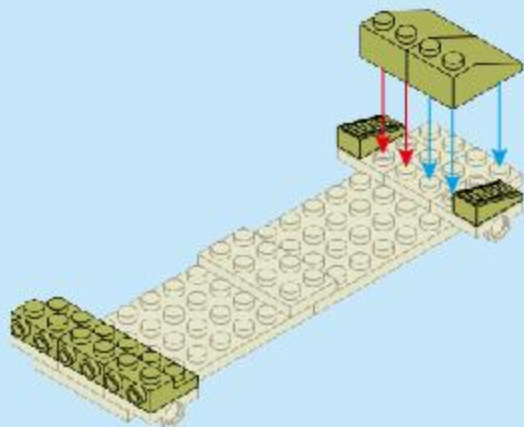

5

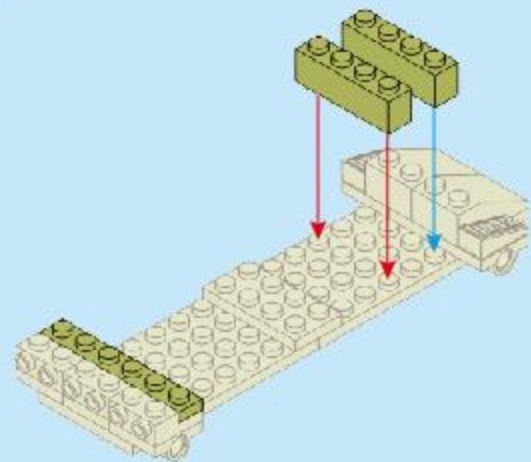

6

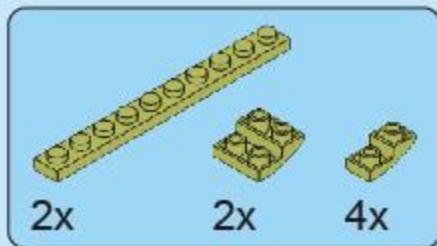
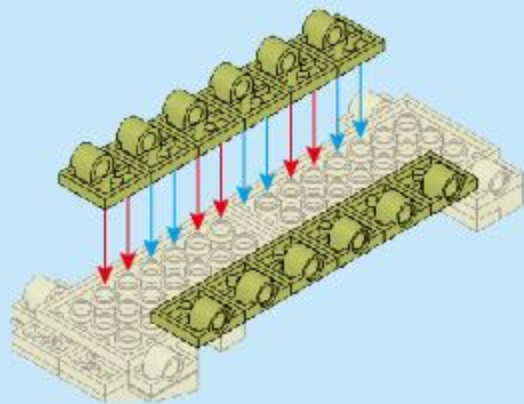

7

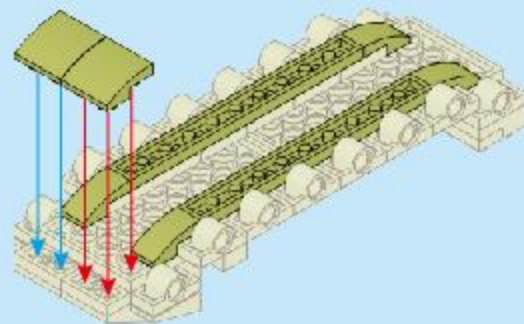

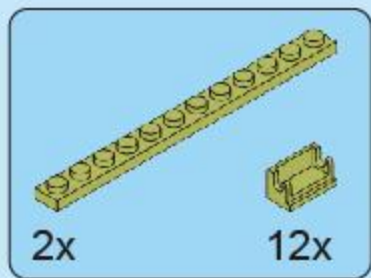

8

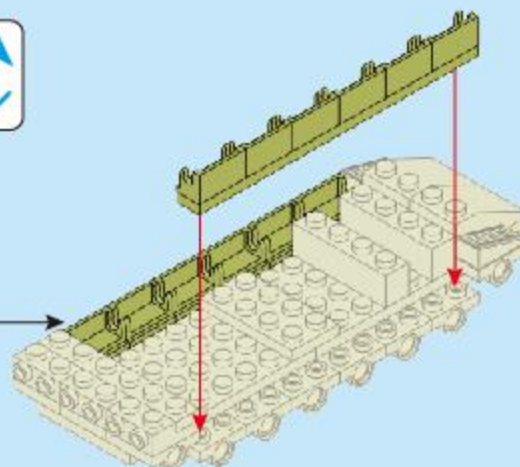
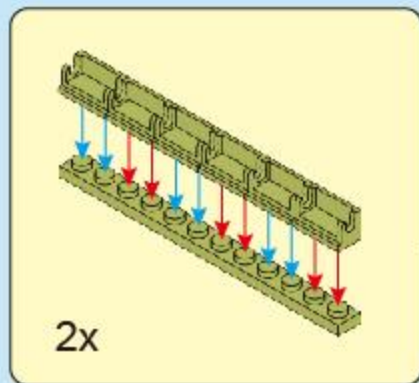

9

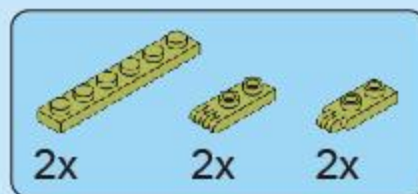
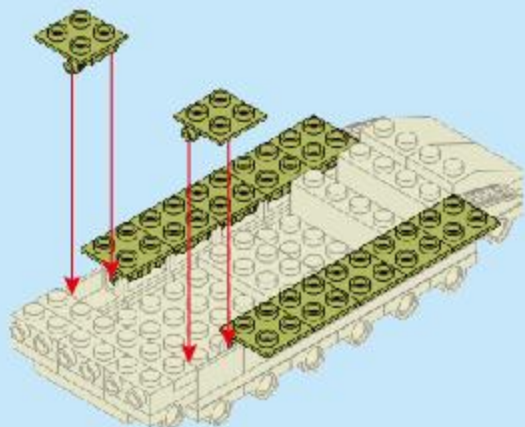

10

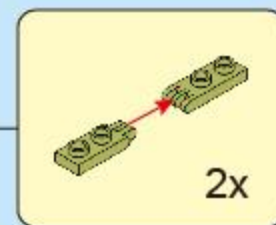
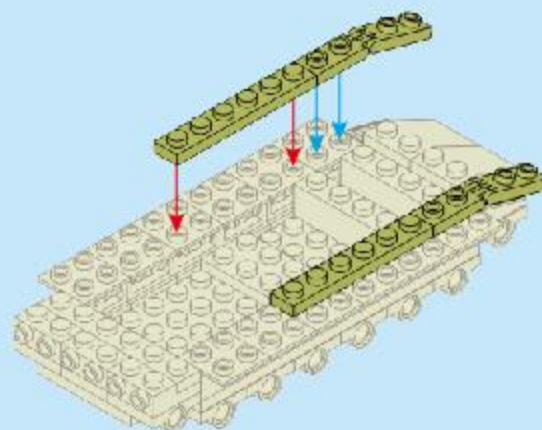

4

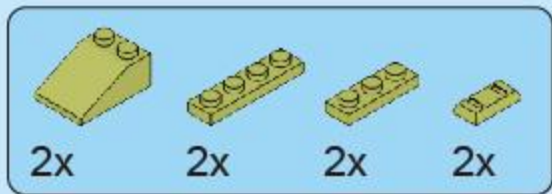

11

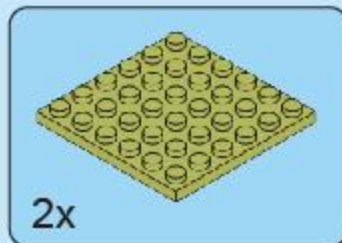
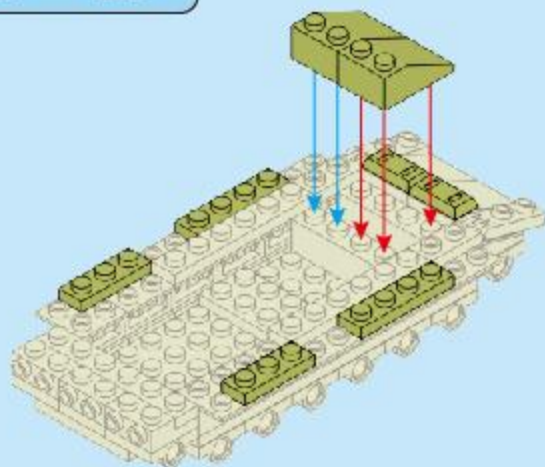

12

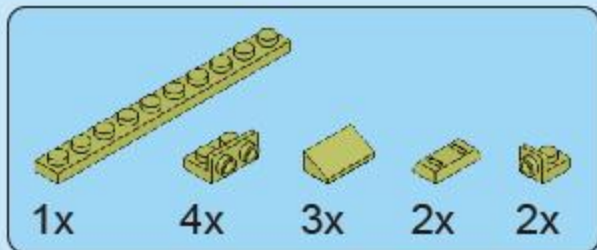
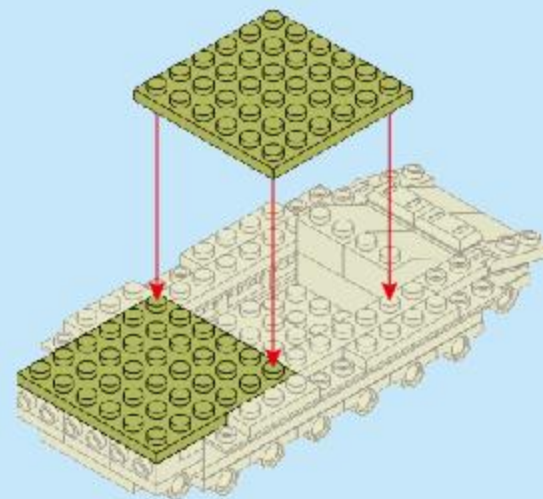

13

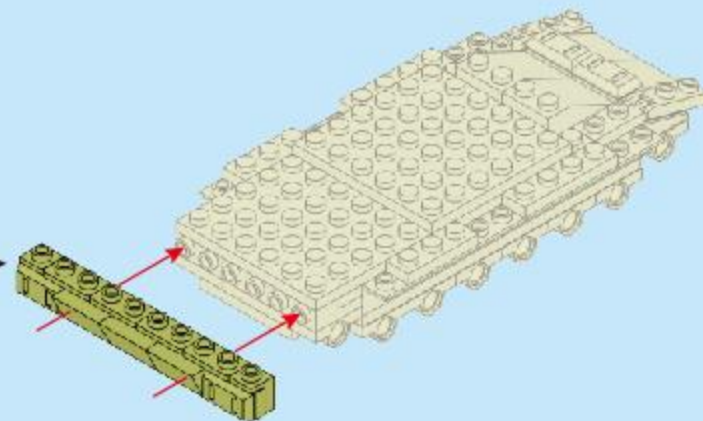
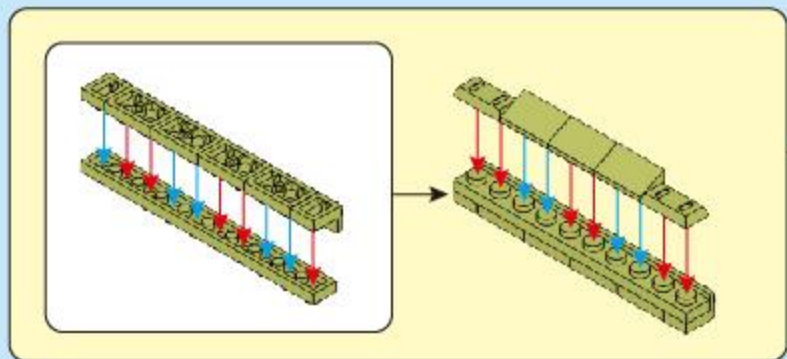



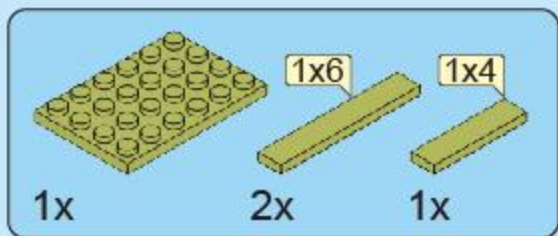

14

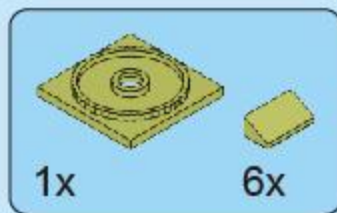
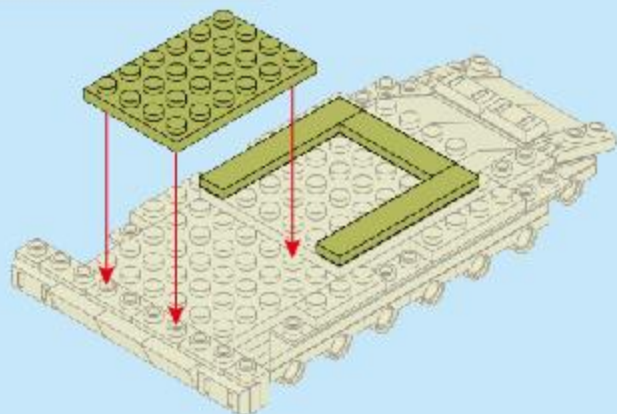

15

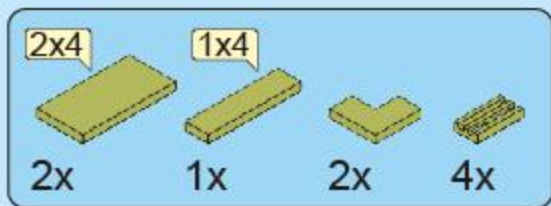
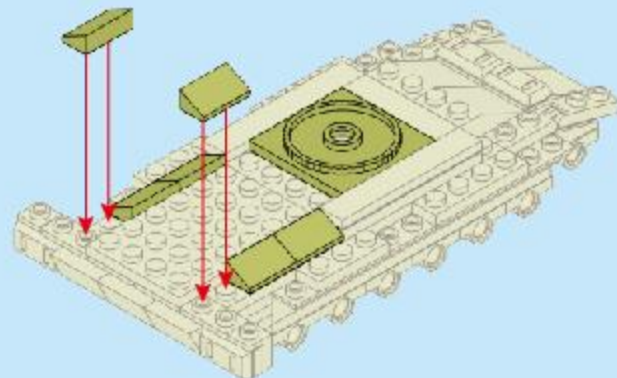

16

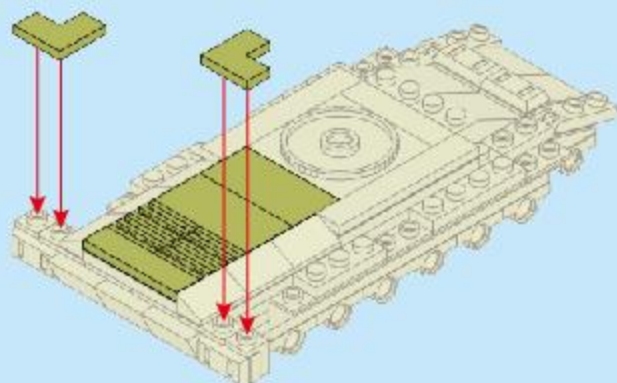

17

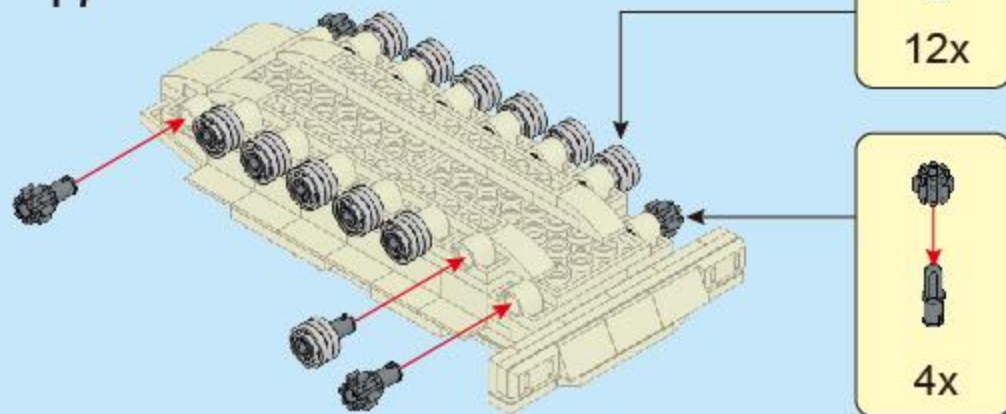

 82x

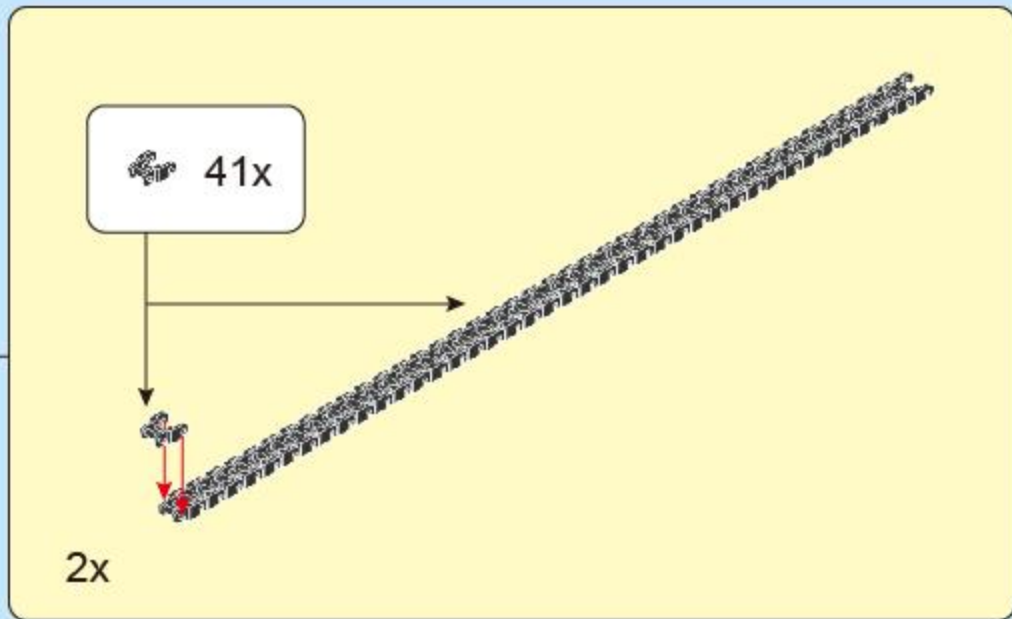
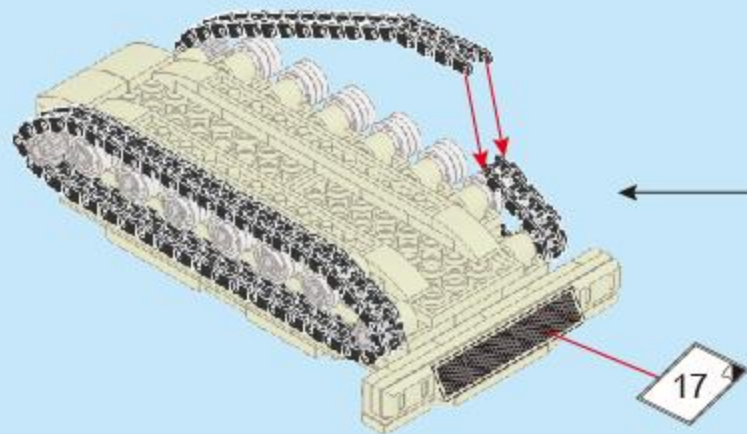

18

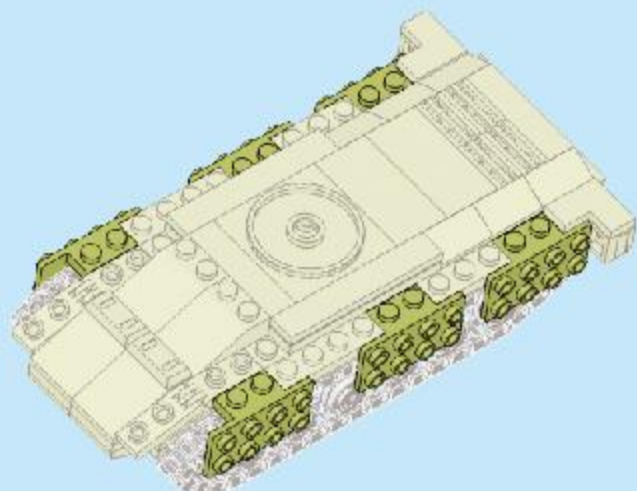

 6x

19



 1x4  
2x  6x

20

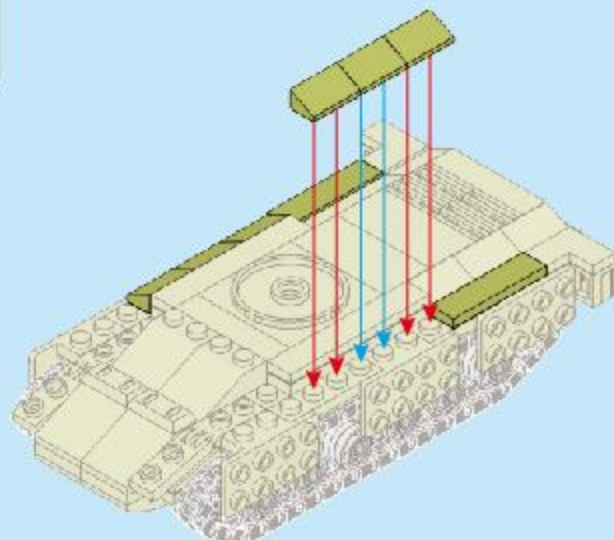

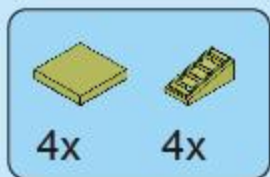

21

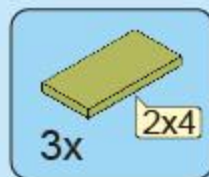
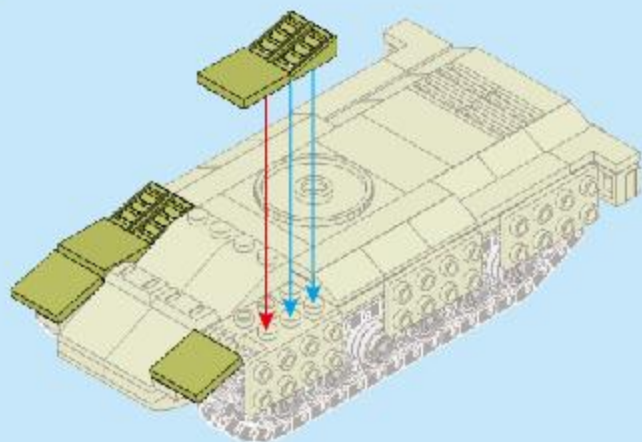

22

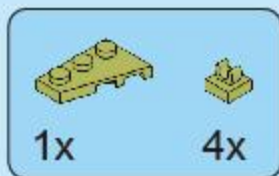
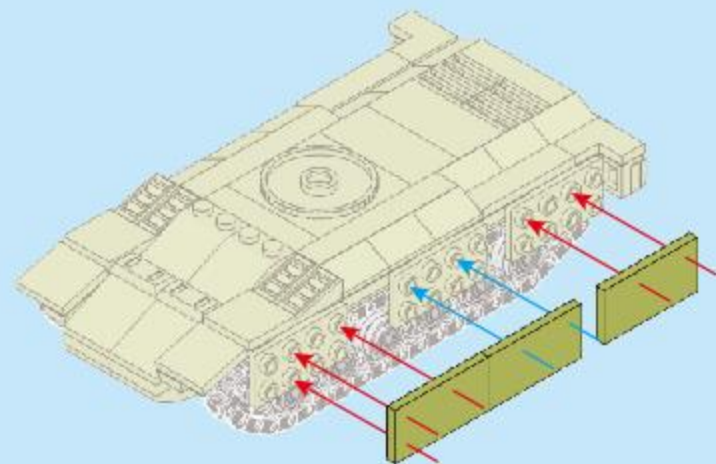

23

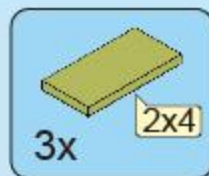
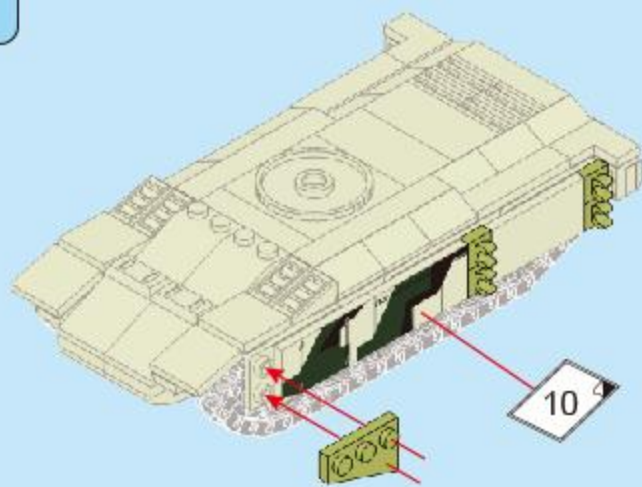

24

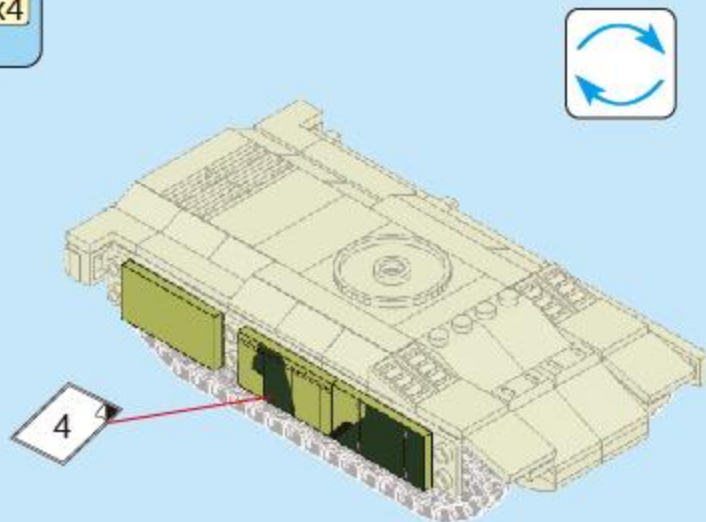



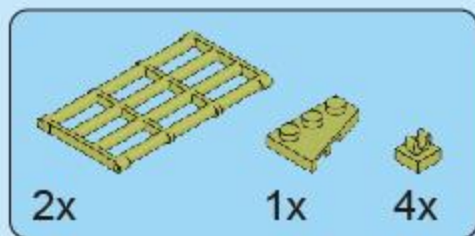

25

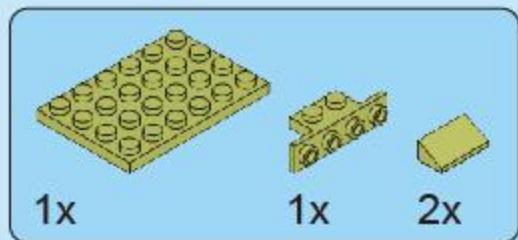
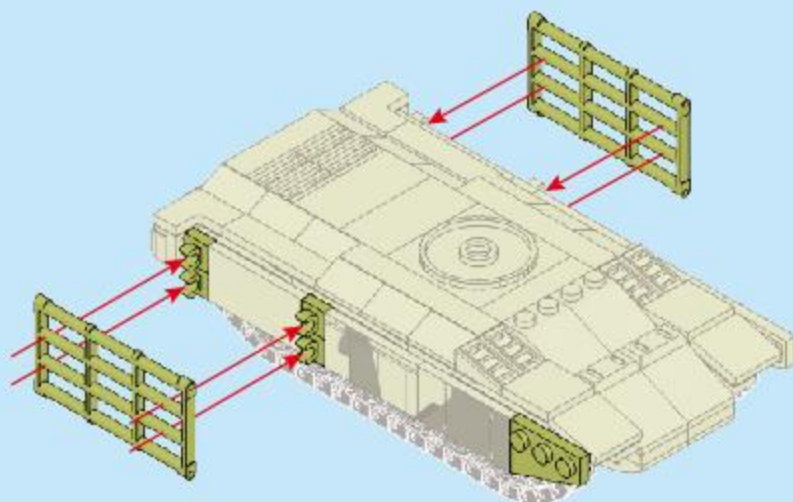

26

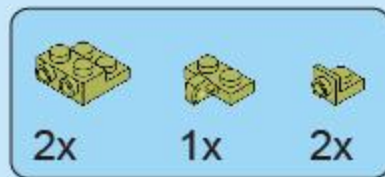
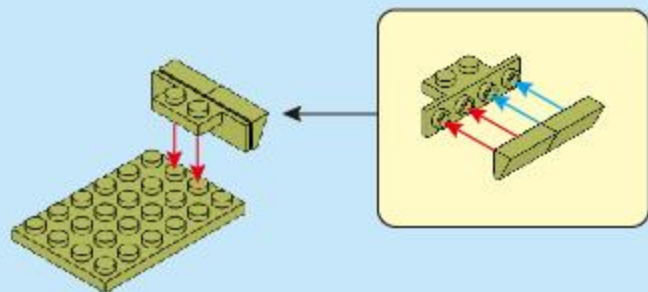

27

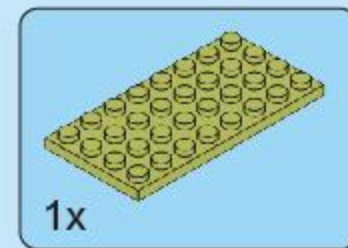
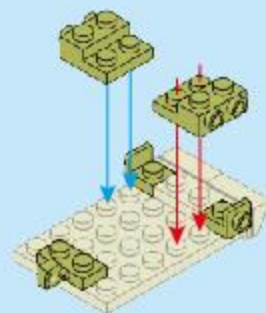

28

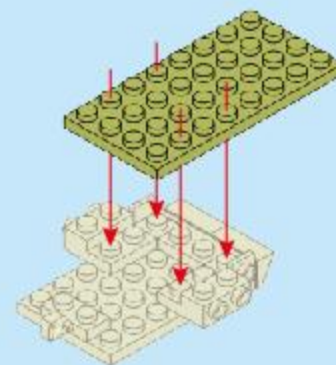

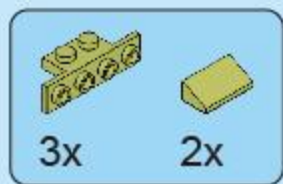

29

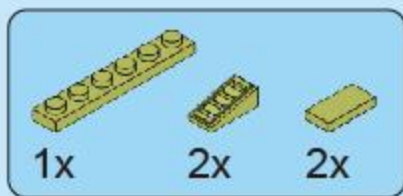
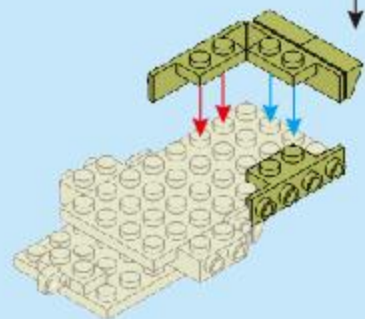
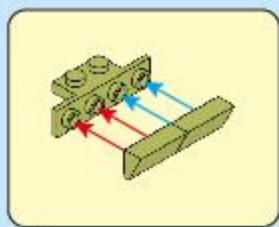

30

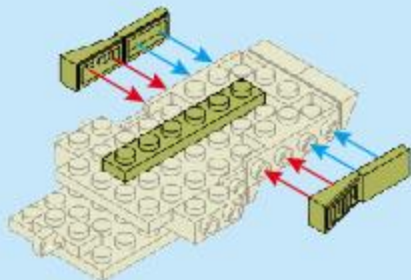

31

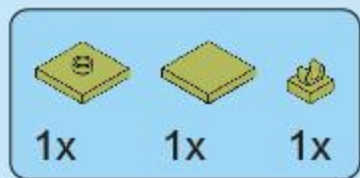
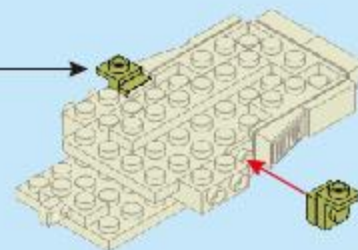
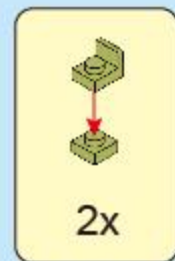

32

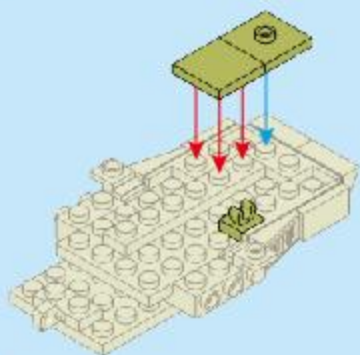

33

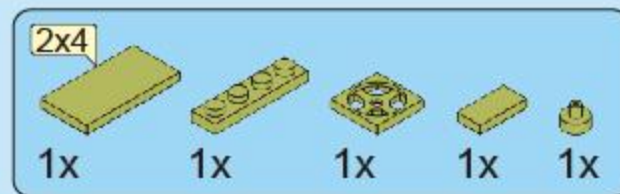
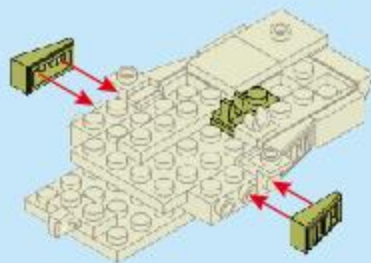

34

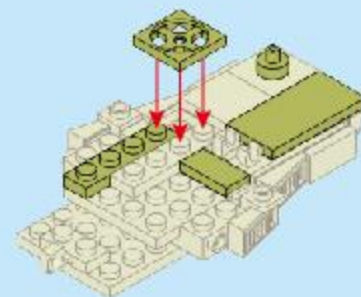





35

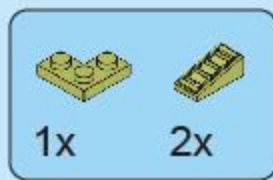
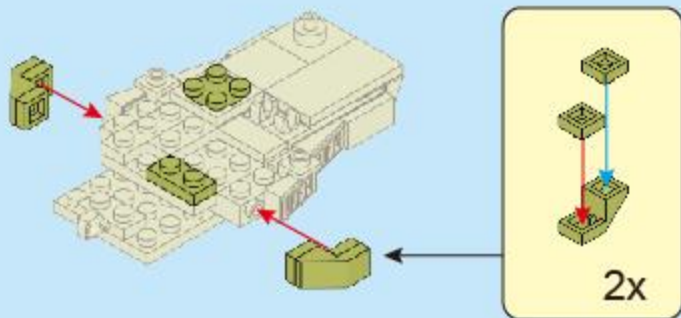

36

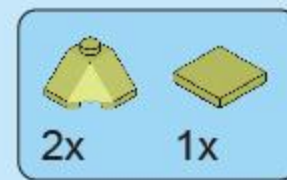
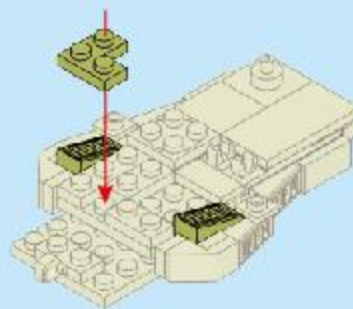

37

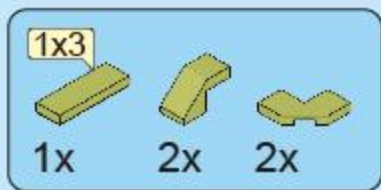
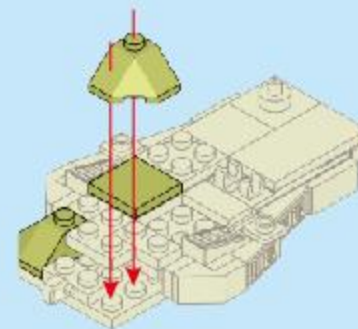

38

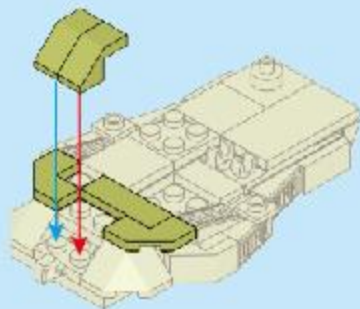

39

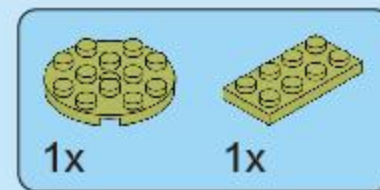
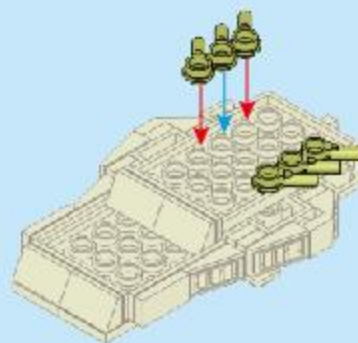

40

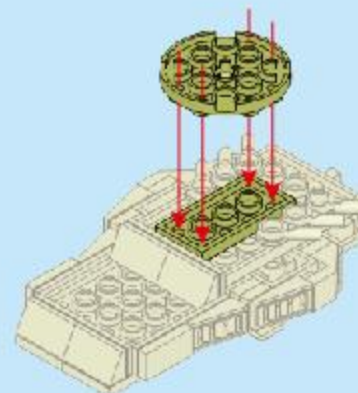

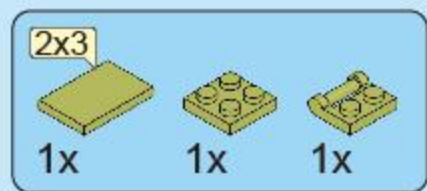

41

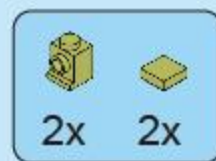
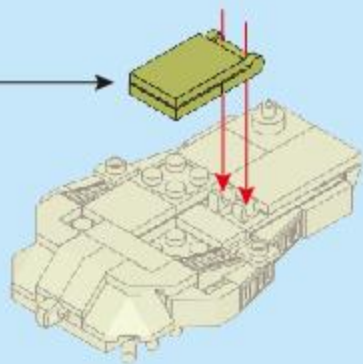
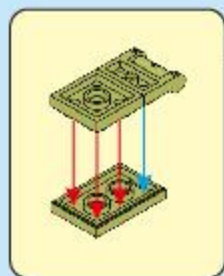

42

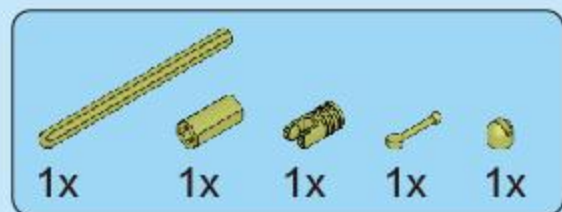
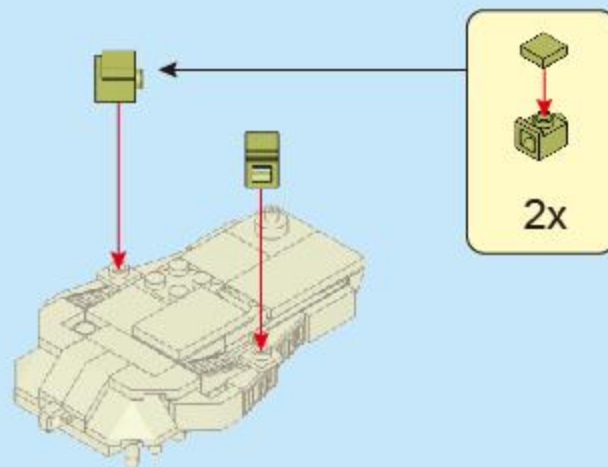

43

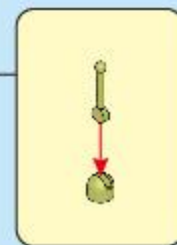
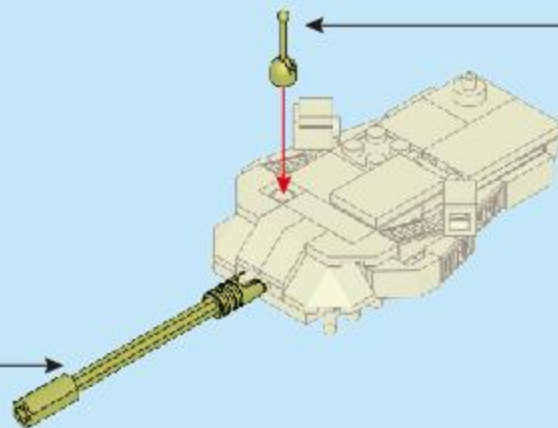
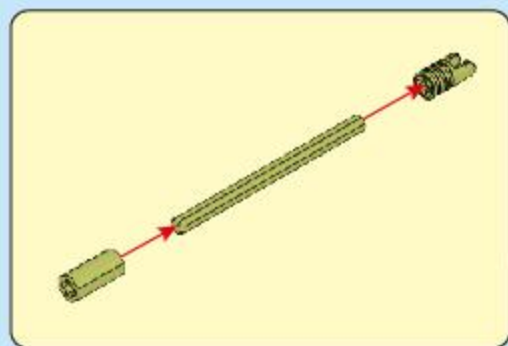





44

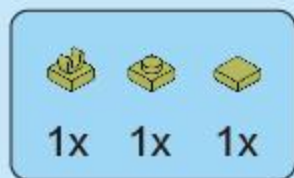
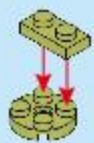

45

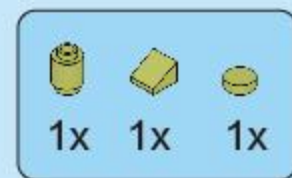
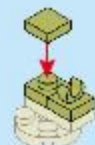

46

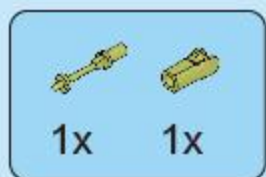
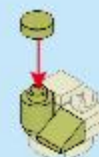

47

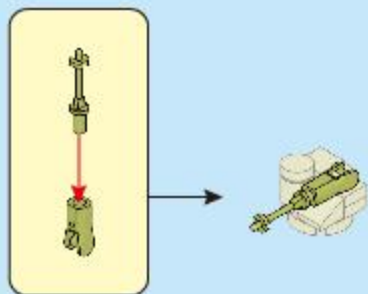

48

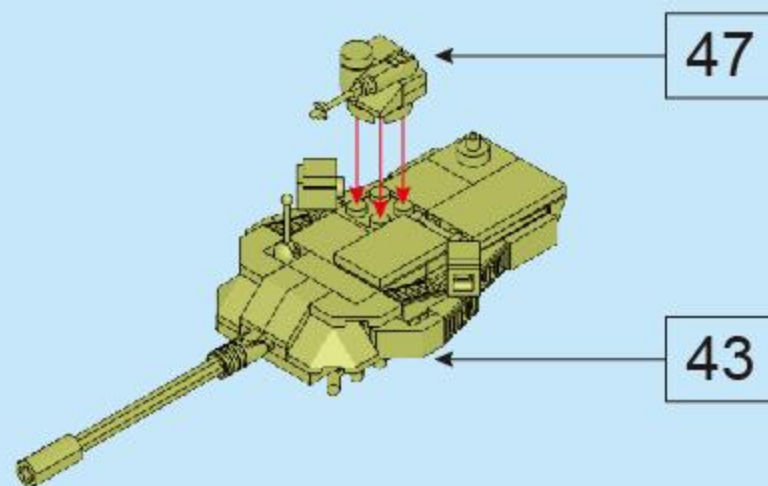

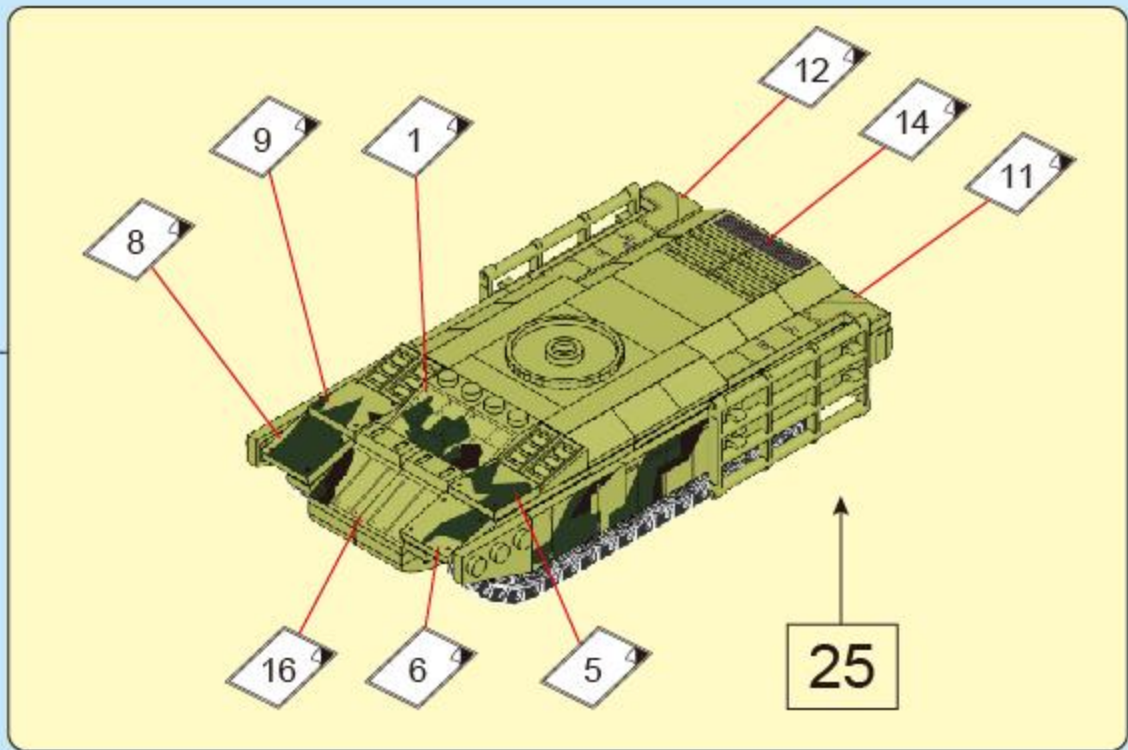
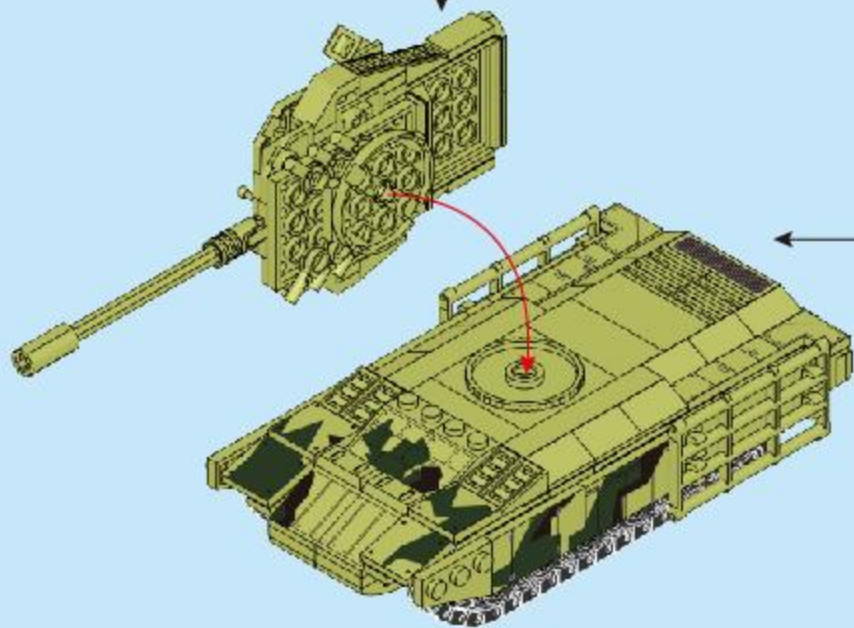
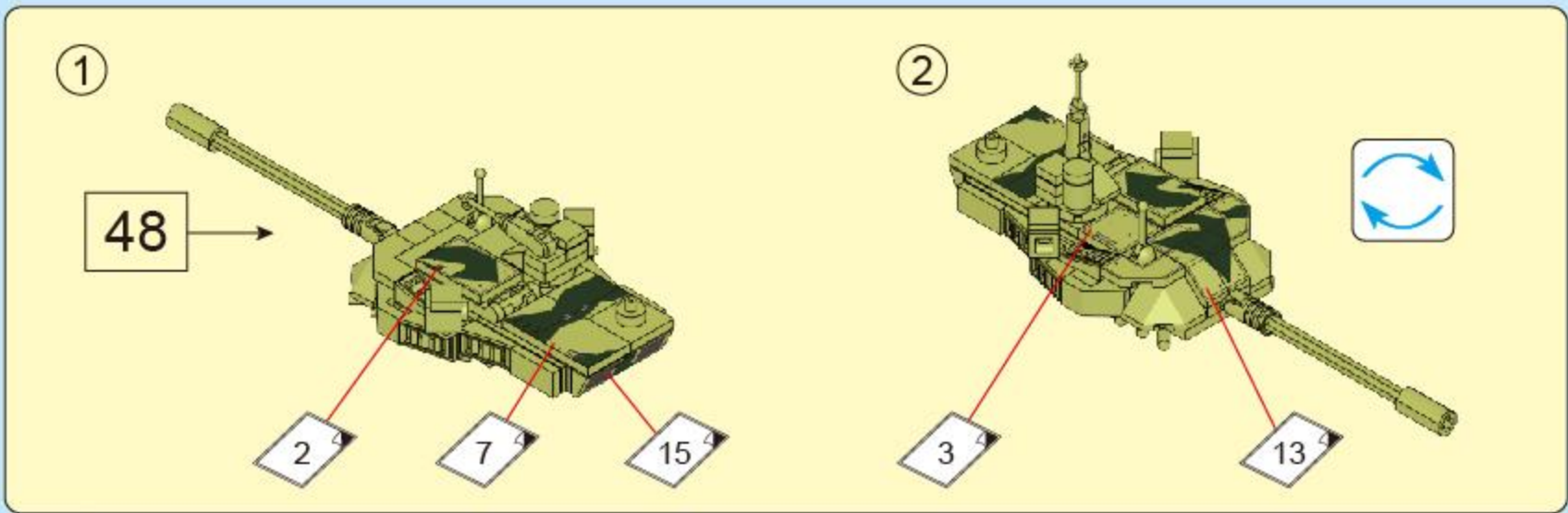





50

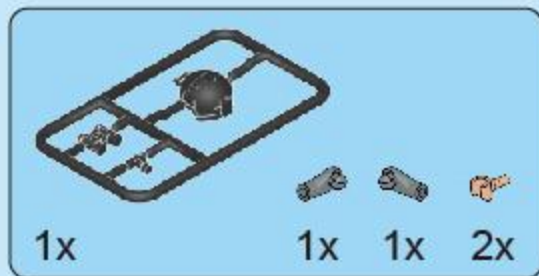
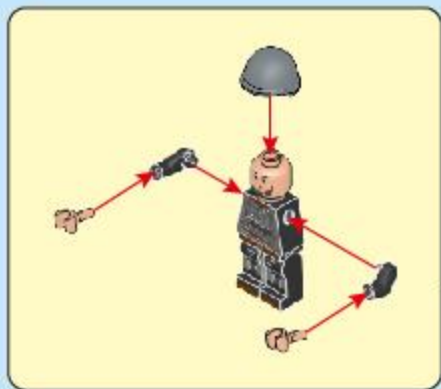

51

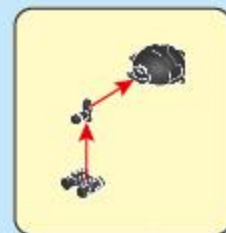
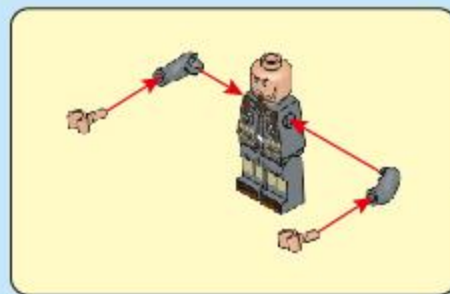

52

