

ENGINE-MORPH



2in1



FC9312-4

MILITARY SUBMARINE FORM

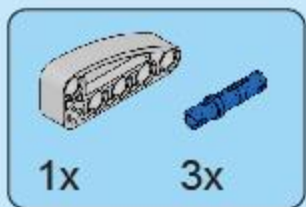

A1



A2

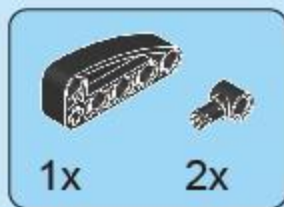

A3

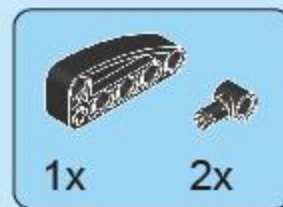

A4

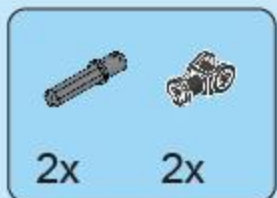
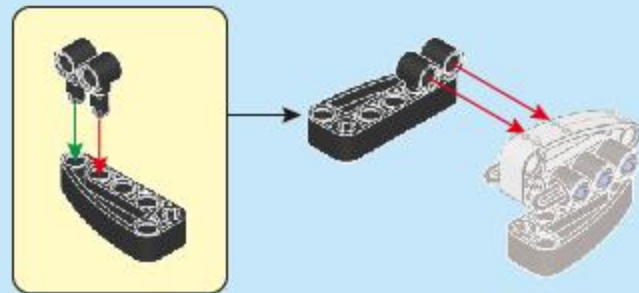
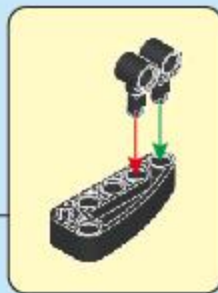
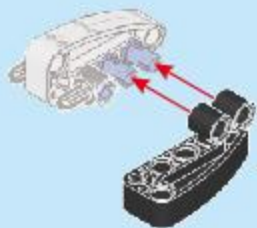
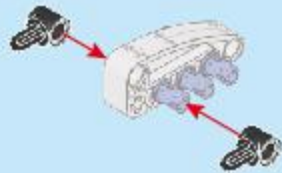
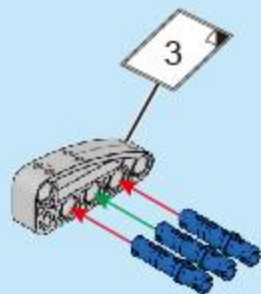

A5



A6



A7



A8

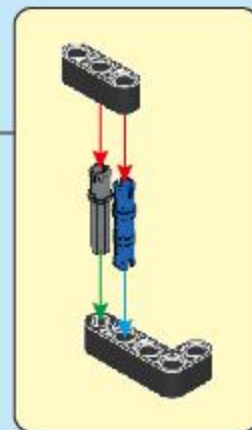
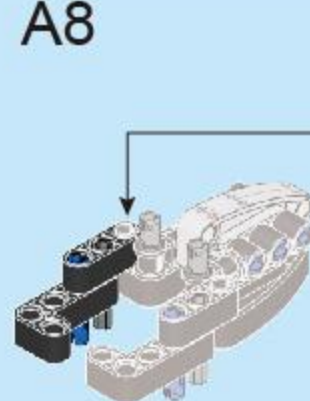
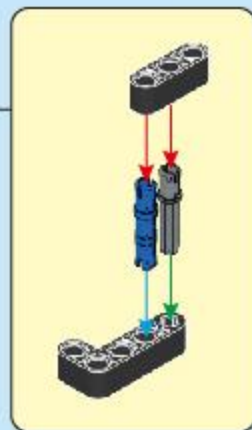
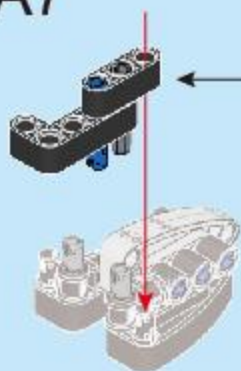
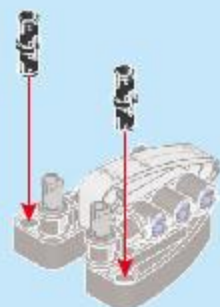
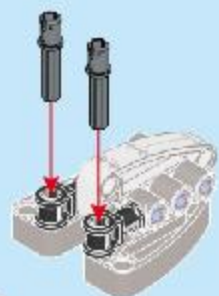



A9

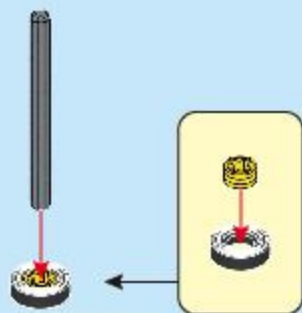

A10

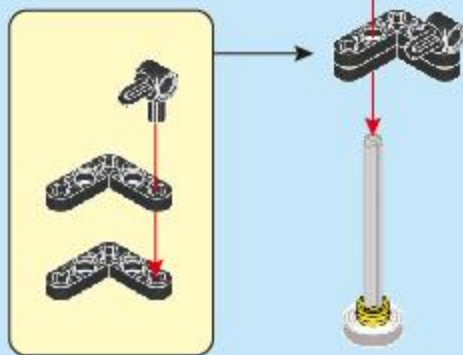

A11

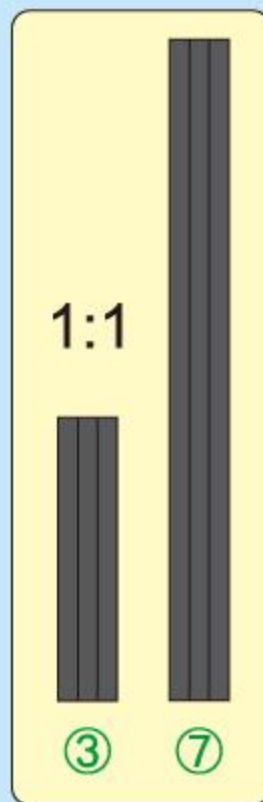
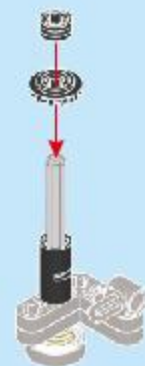

A12

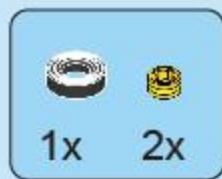
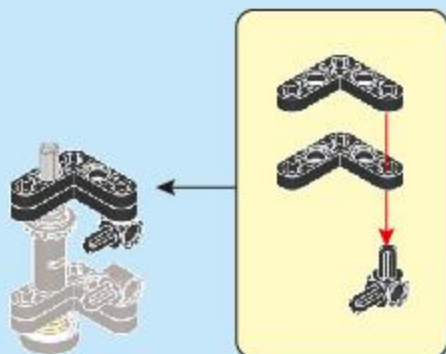

A13

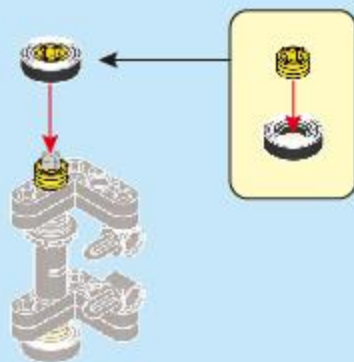

A14

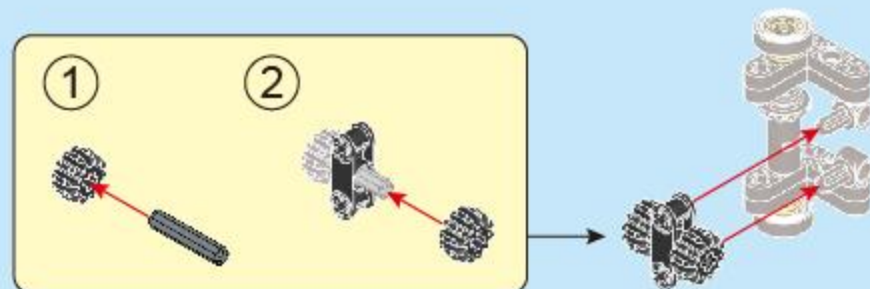

A15

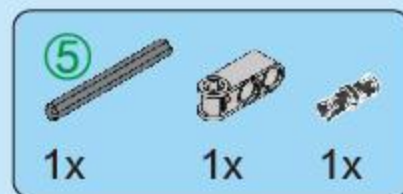

A16

A17

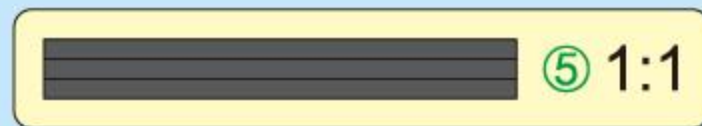
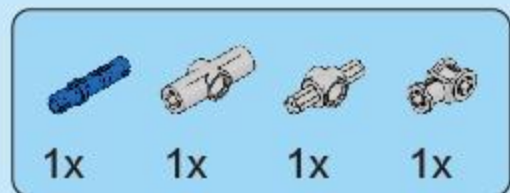
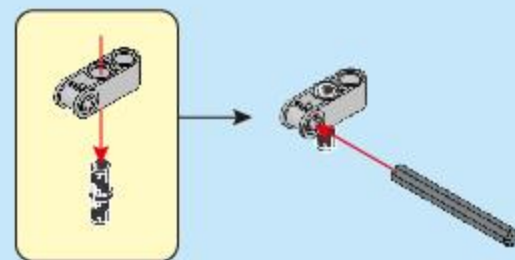
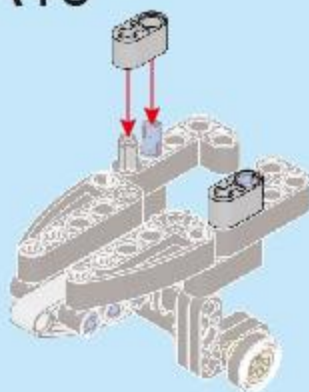
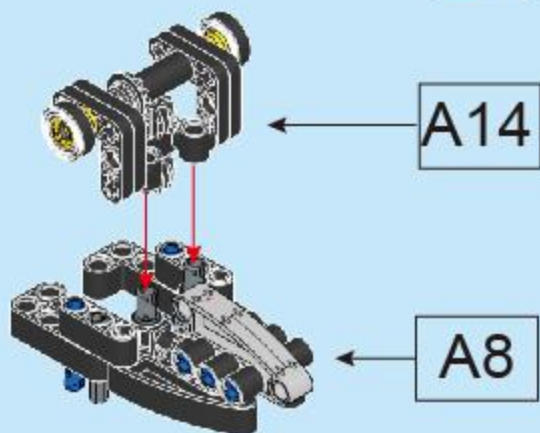

A18

A19

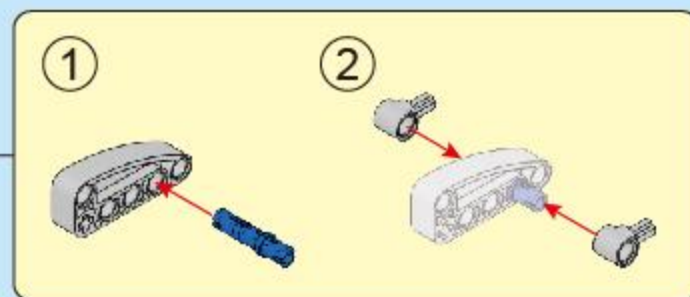
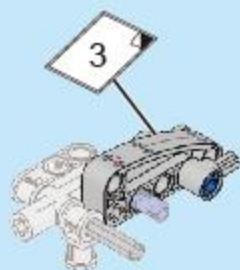
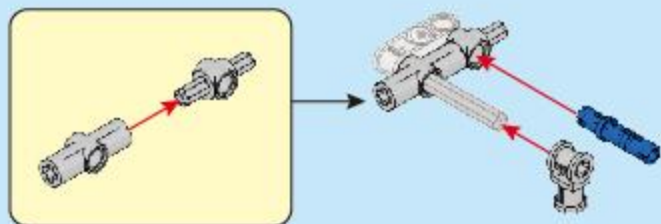

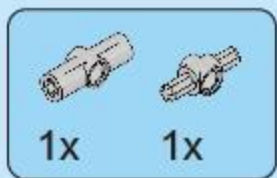

A20

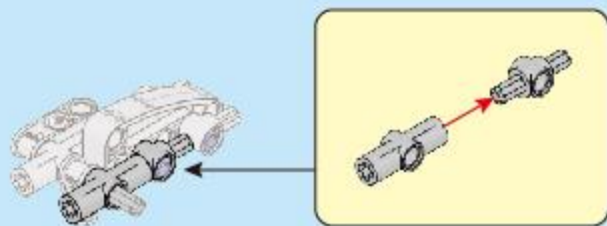

A21

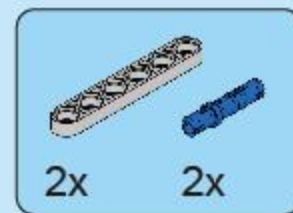
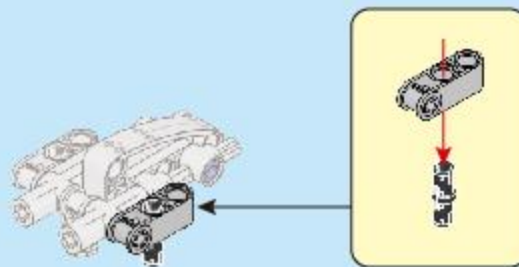

A22

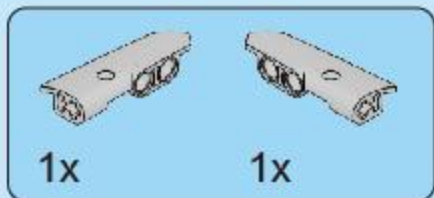
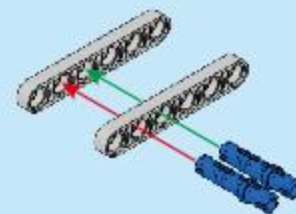

A23

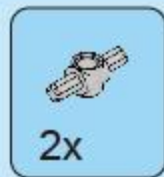
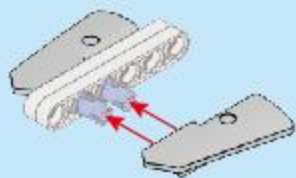

A24

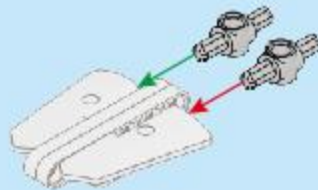

A25

A24

A21

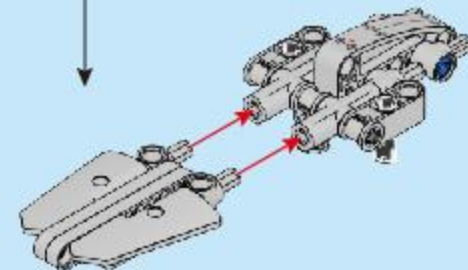



A26

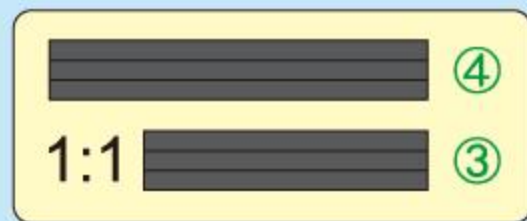
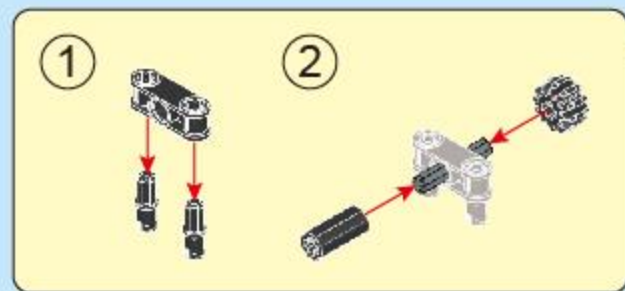

1:1

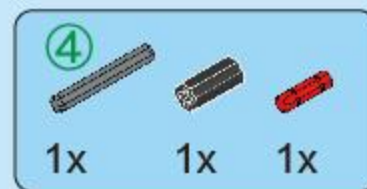
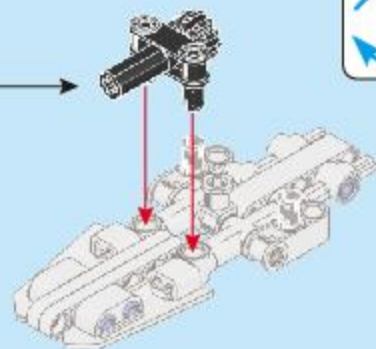

A27

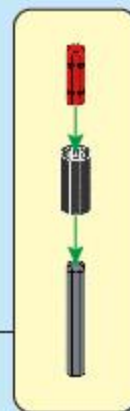
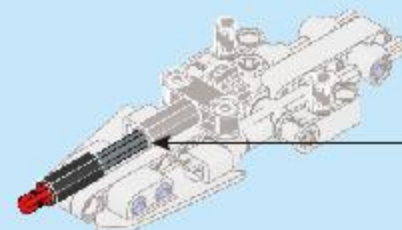

A28

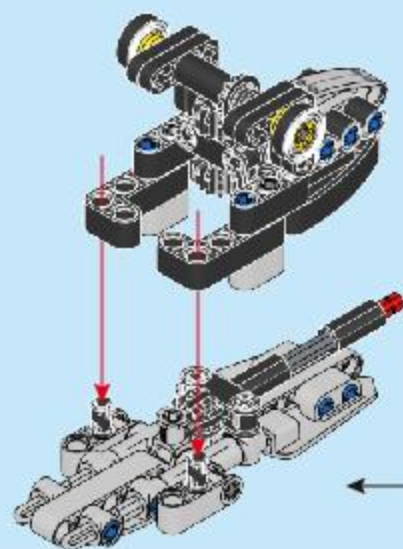

A16



A27



A29

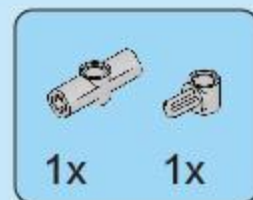

A30

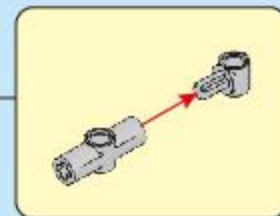
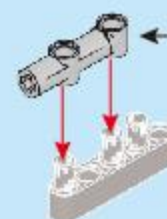

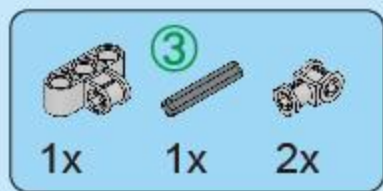

A31

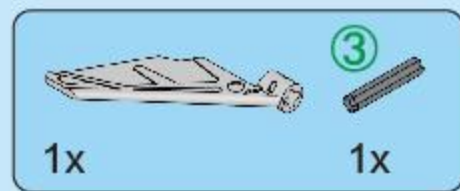
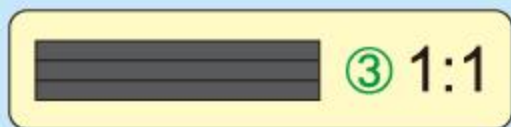

A32



A33

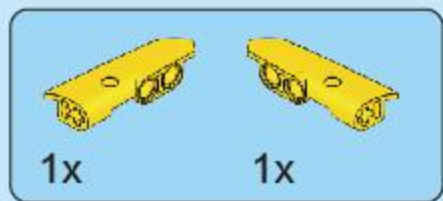
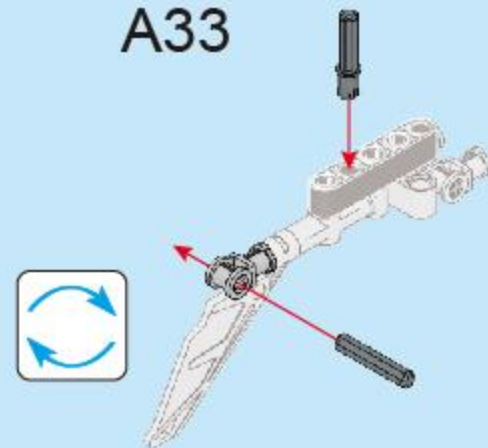
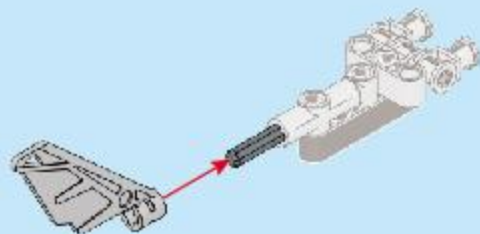
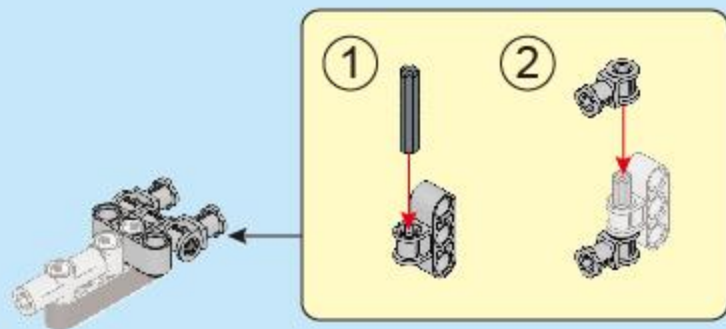

A34

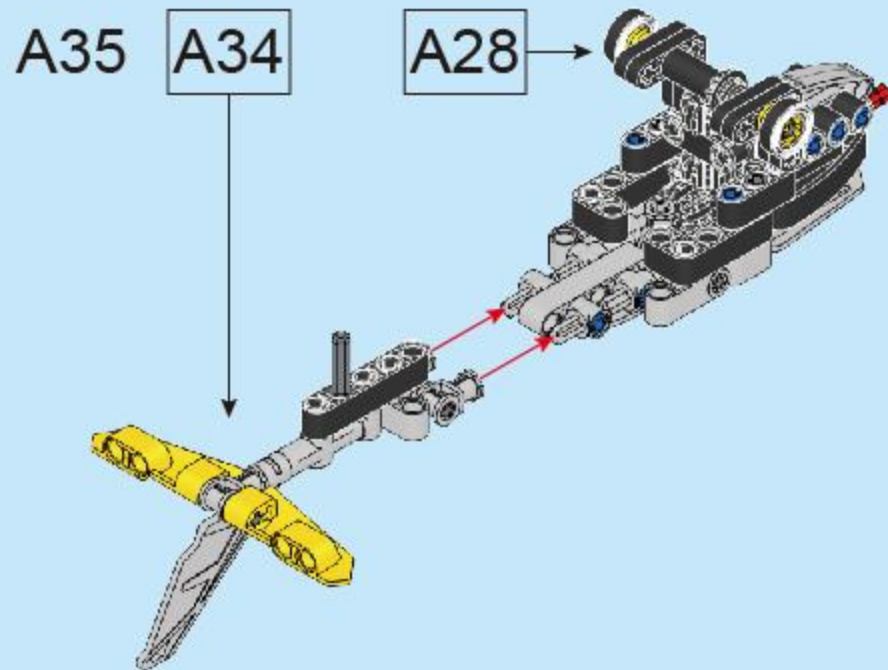
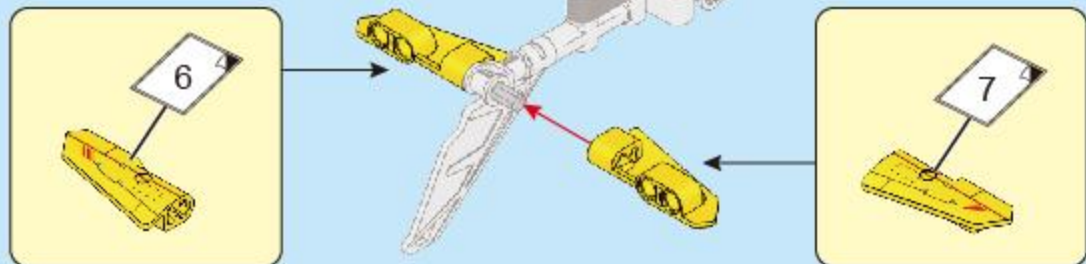

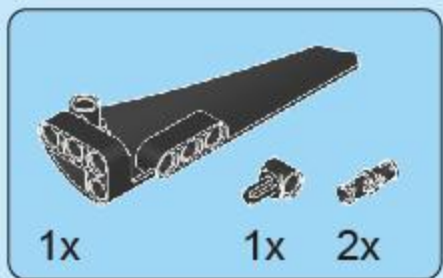

A36

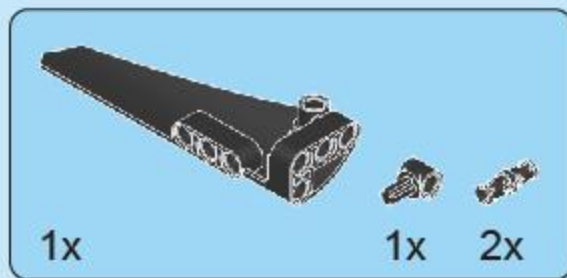
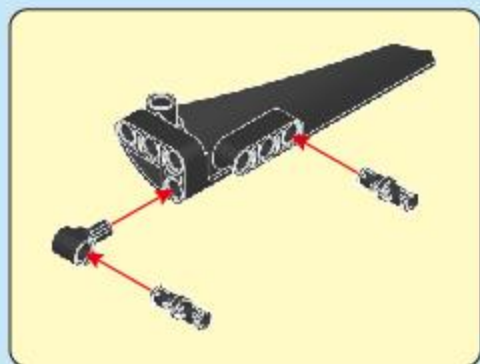

A37

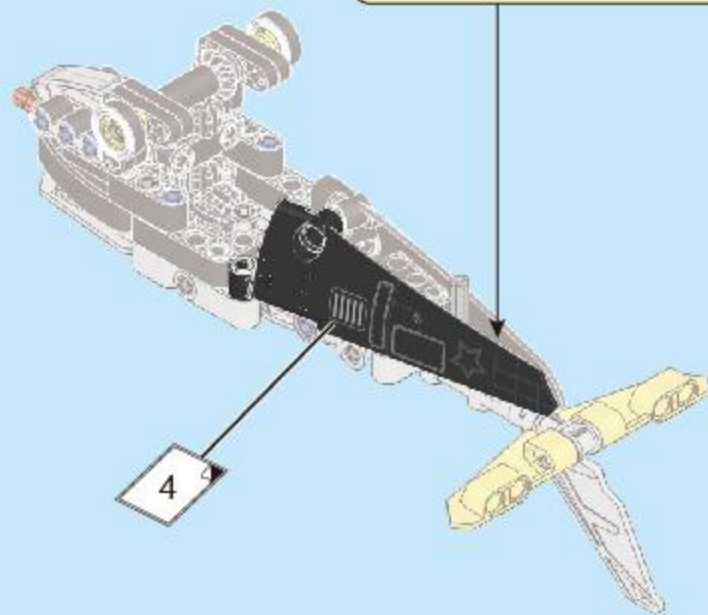
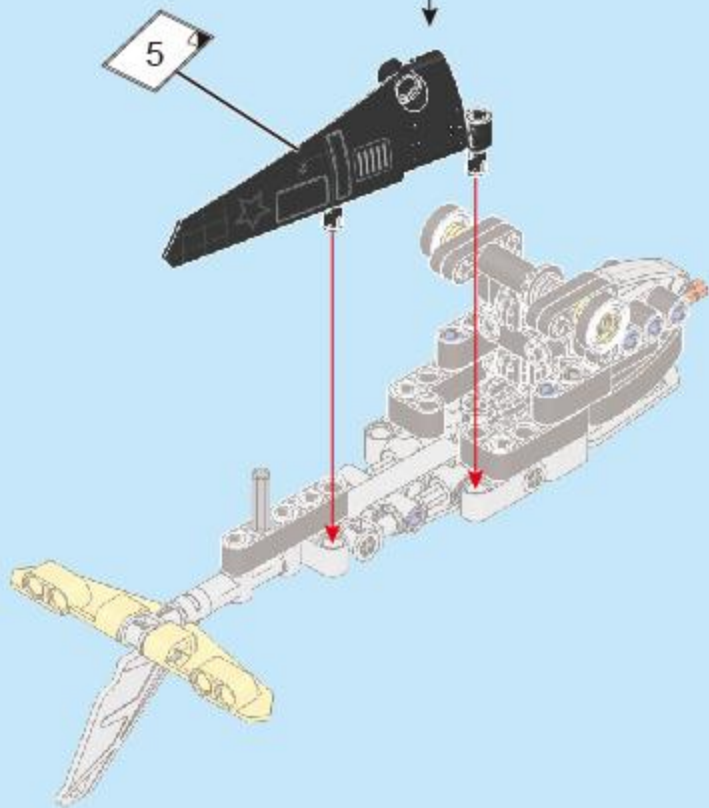
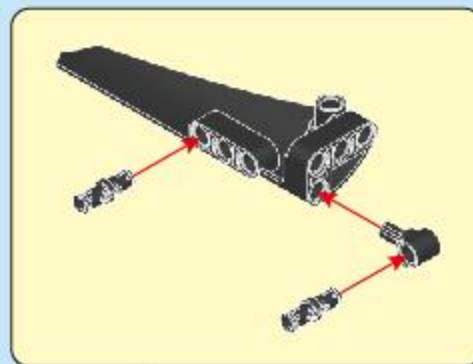



A38

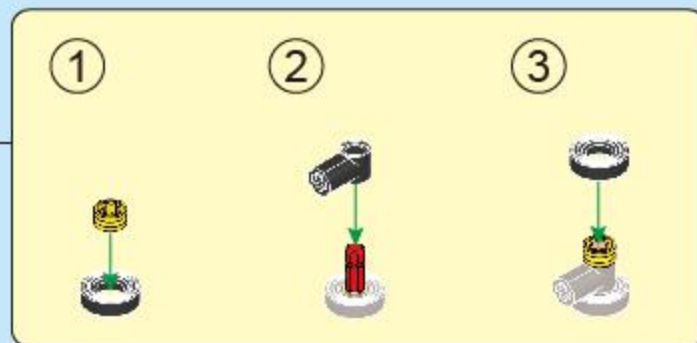
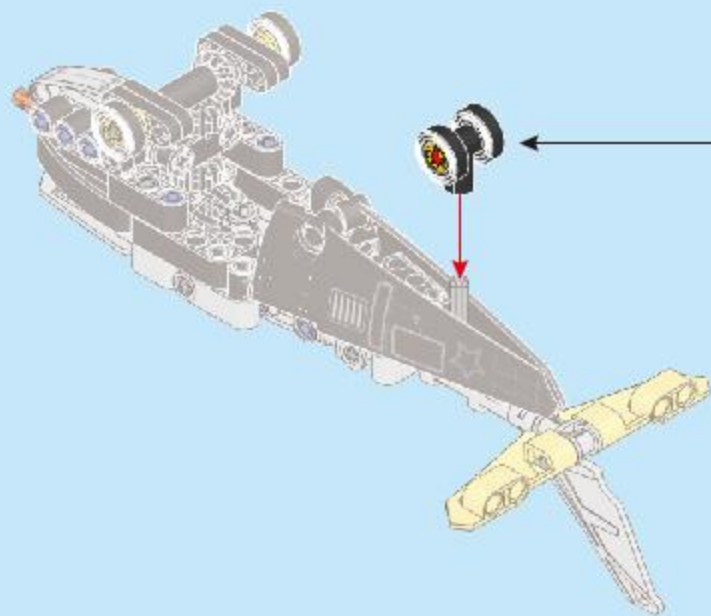

A39

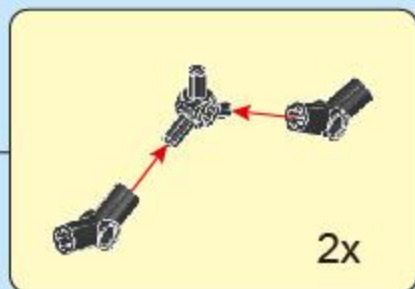
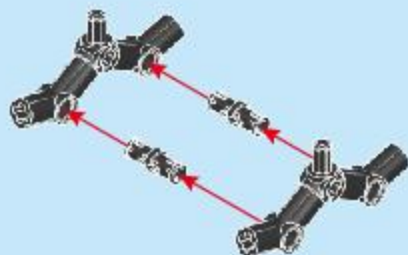

A40



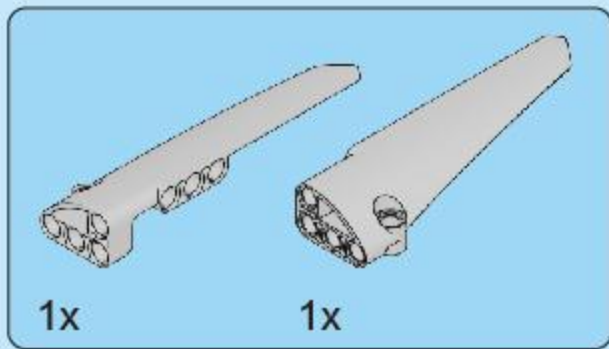

1x

1x

A41

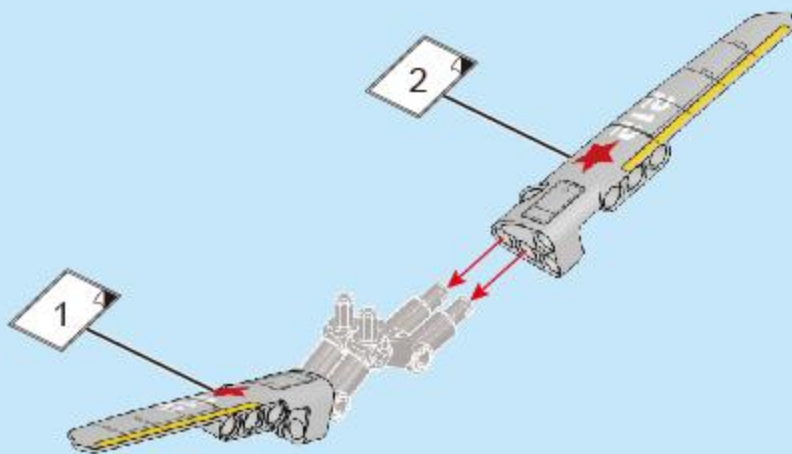

4x

2x

A42

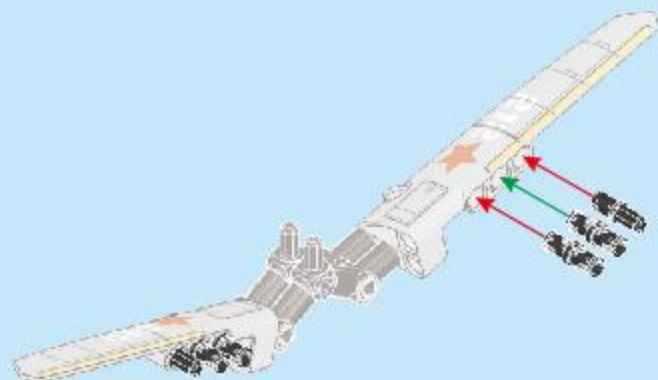

10



2x

4x

2x

A43

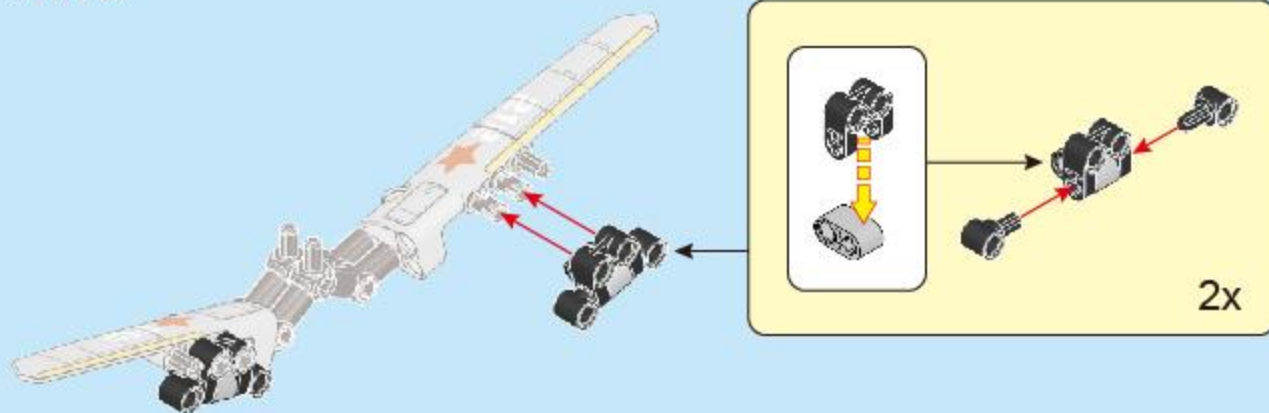

2x



A44

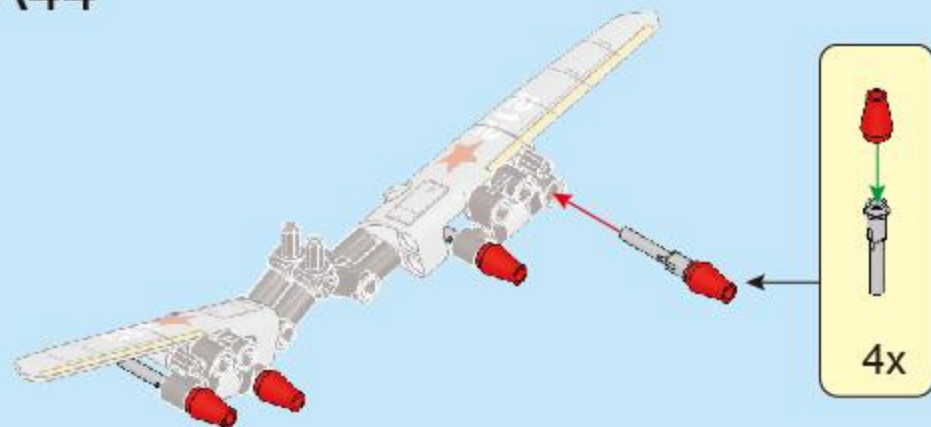

A45

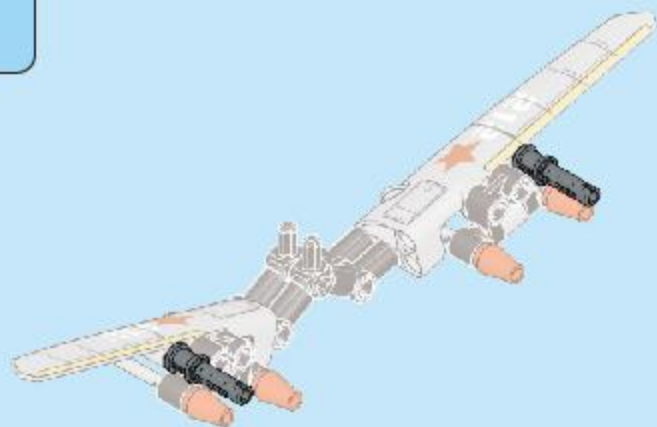

A46

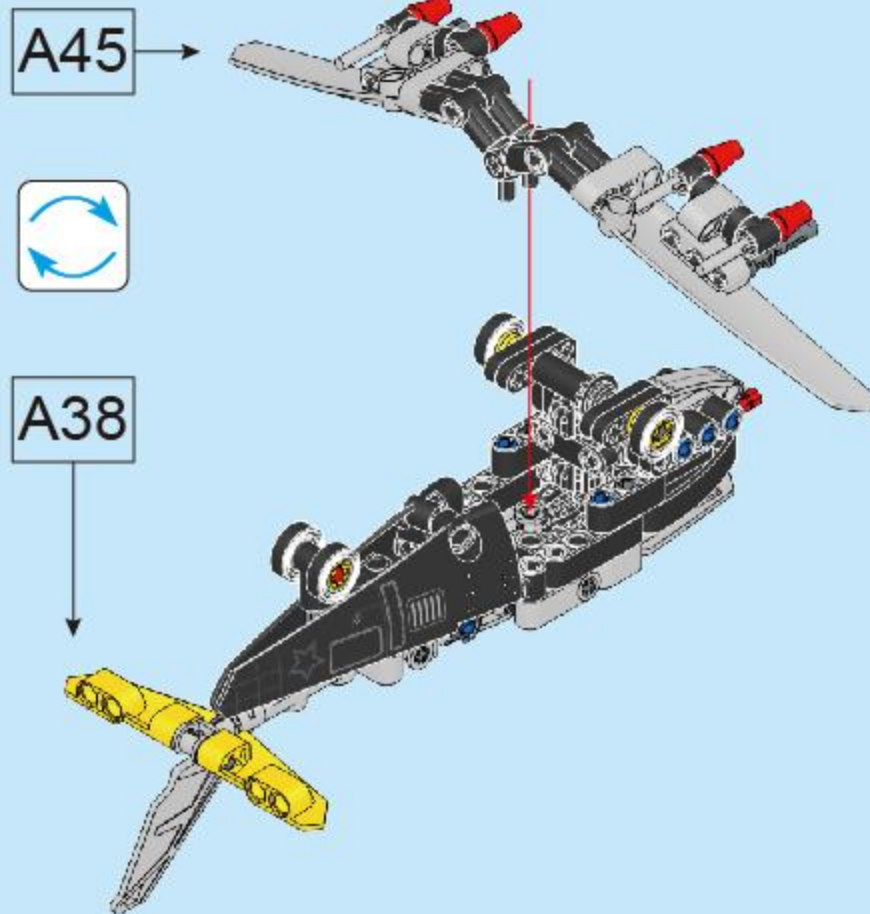

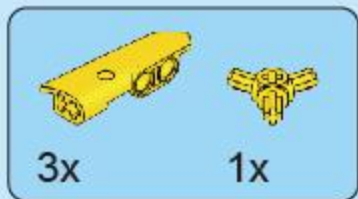

A47

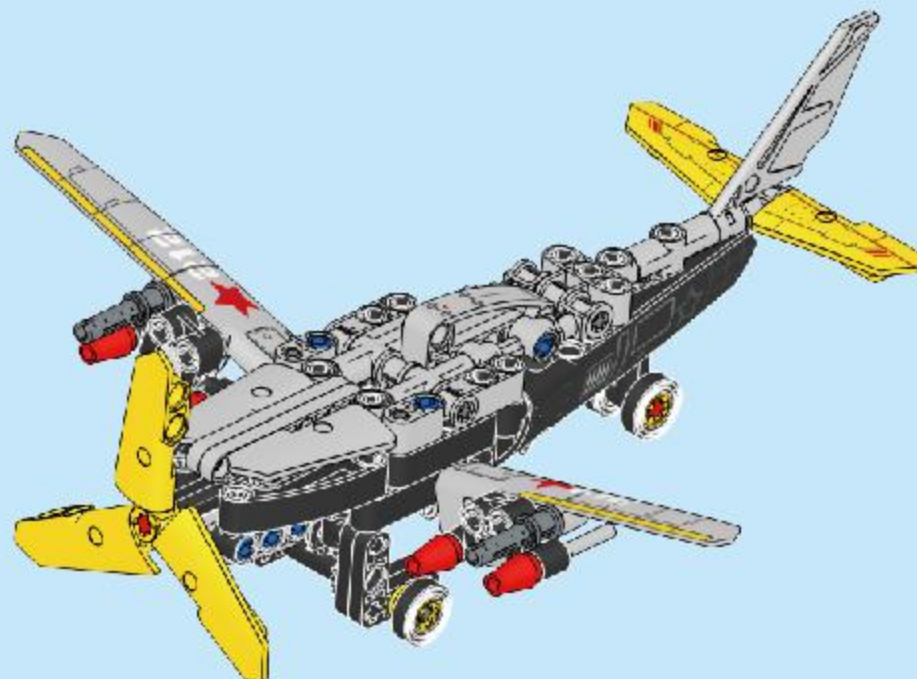
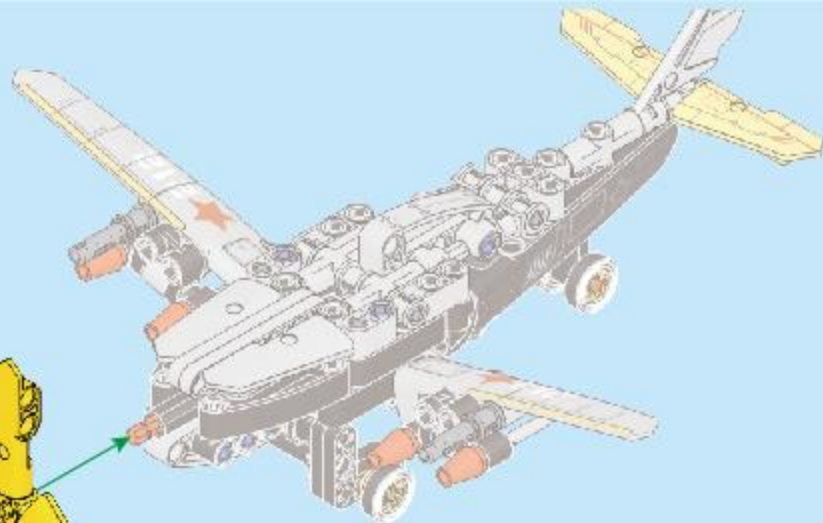
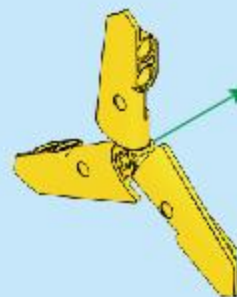
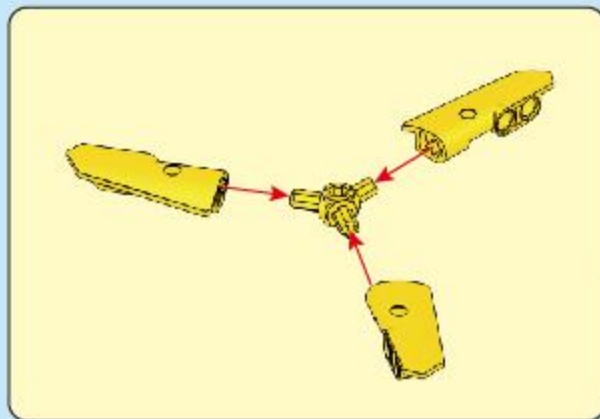

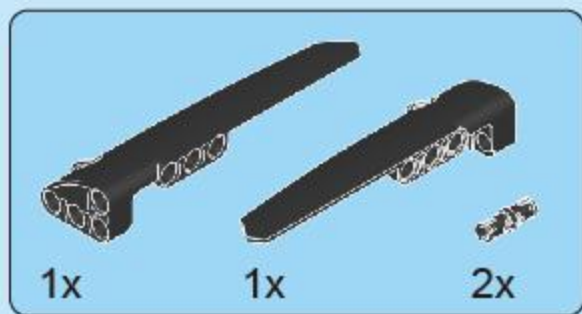

B1

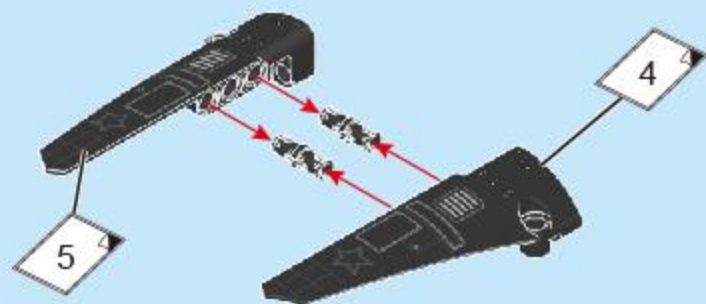

B2

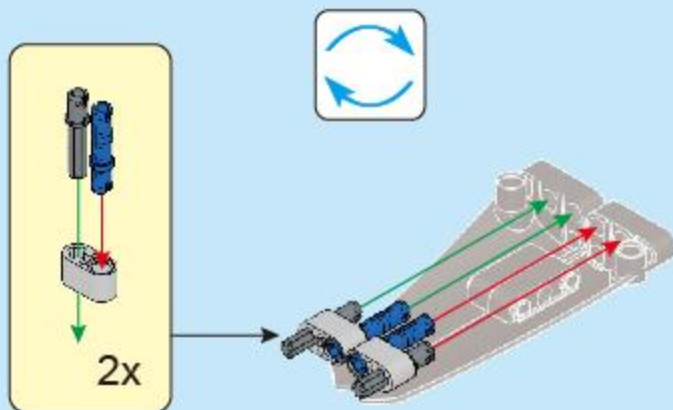

B3

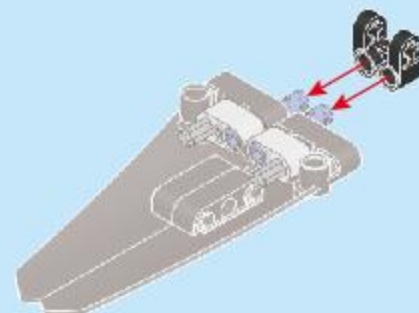

B4

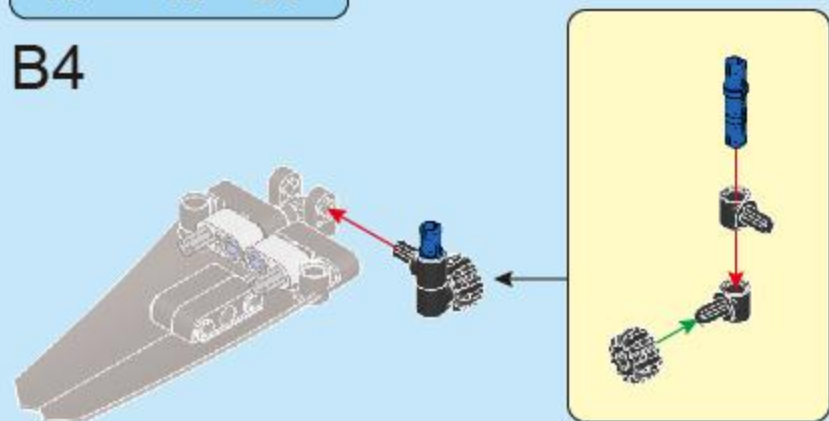

B5

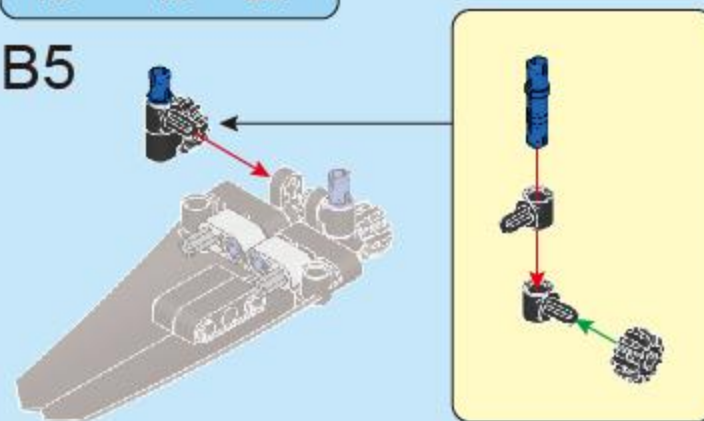

B6

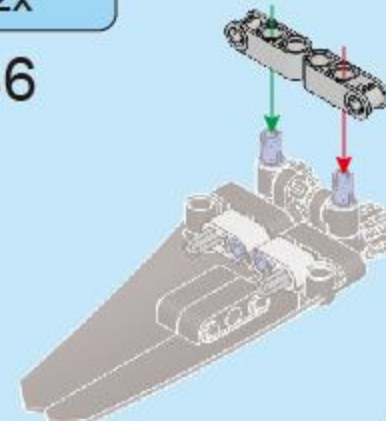

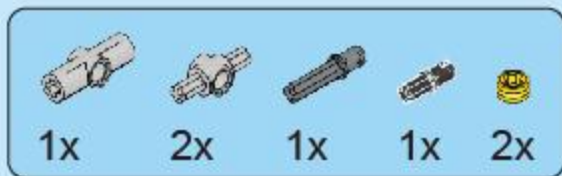

B7

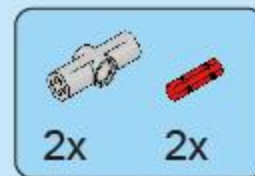
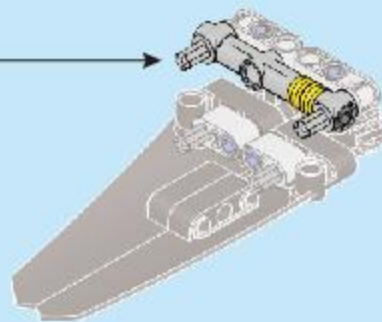
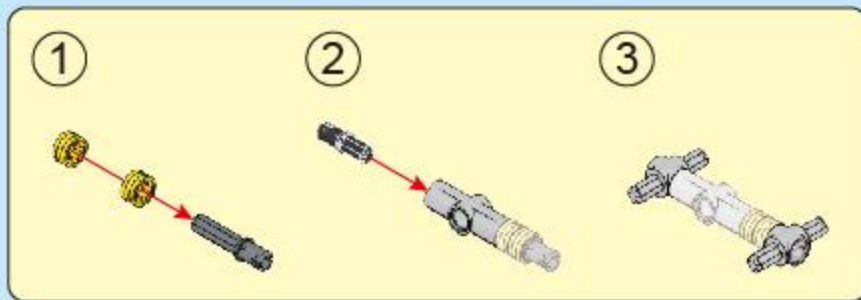

B8

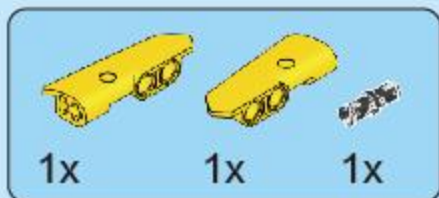
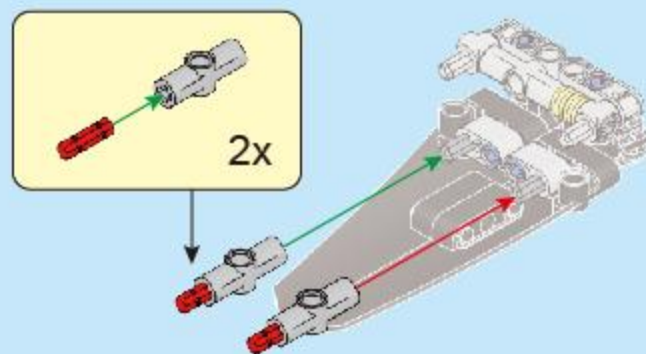

B9

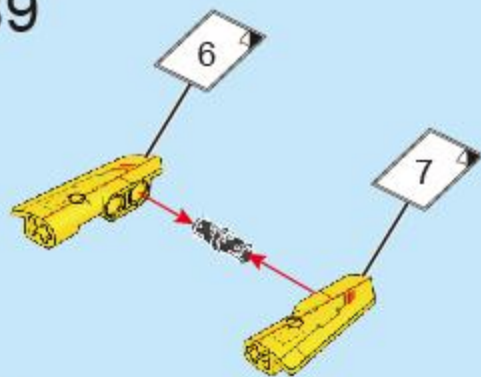

B10

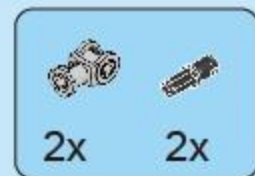
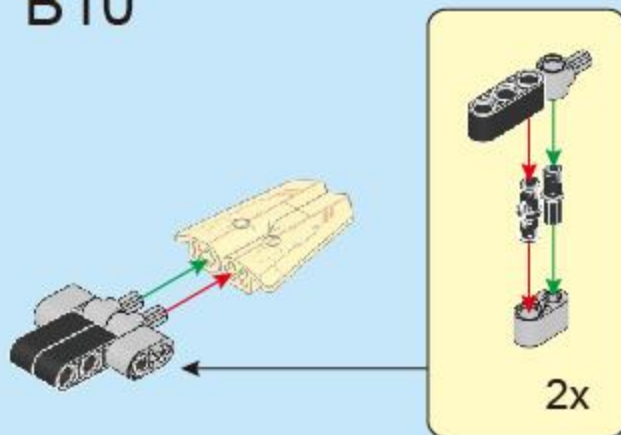

B11

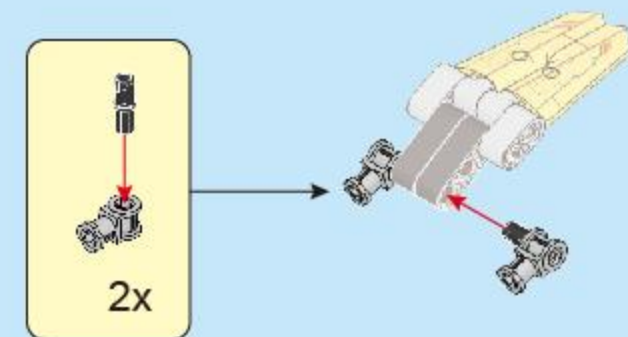

B12

B11

B8

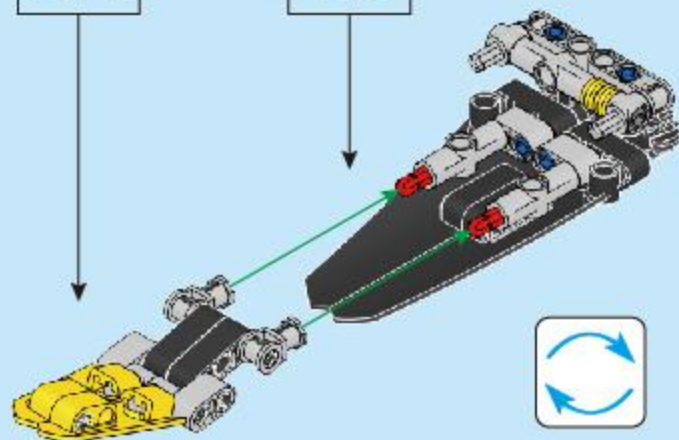

B13

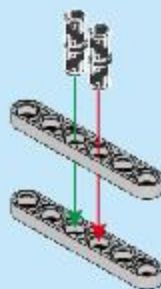

B14



B15

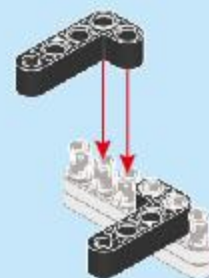

B16



B17

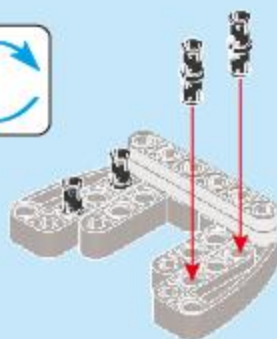

B18

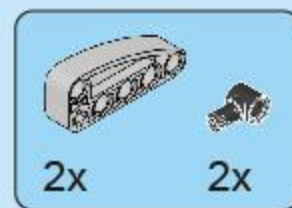
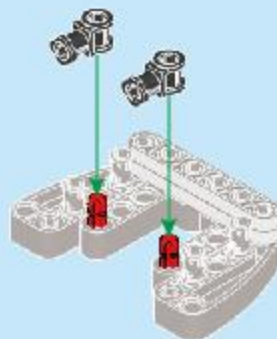

B19

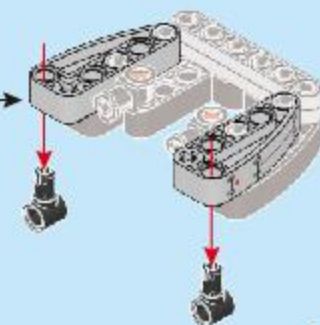
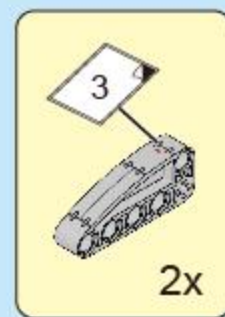

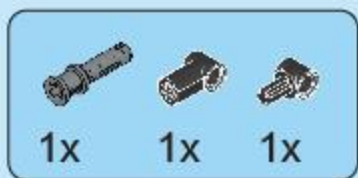

B20

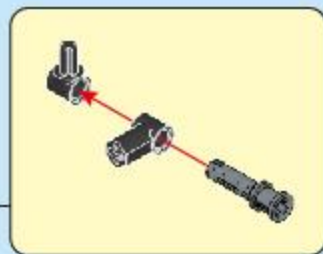
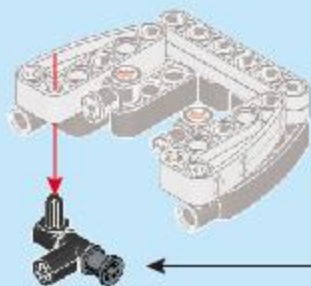

B21

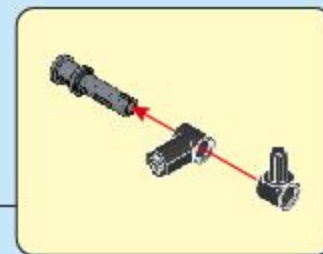
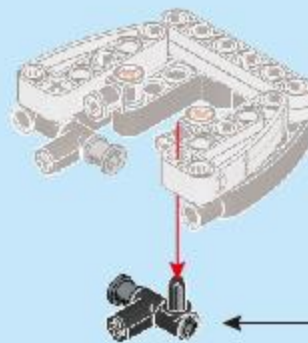

B22

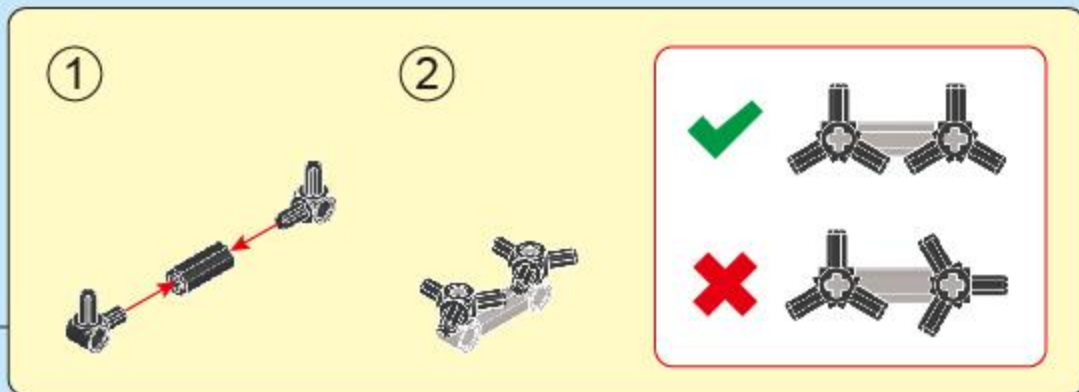
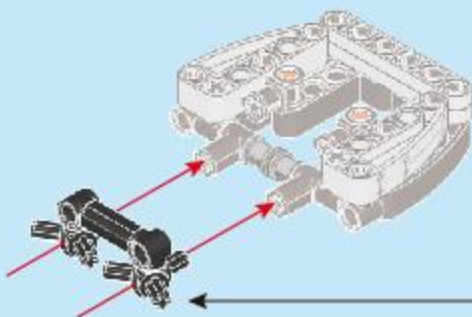

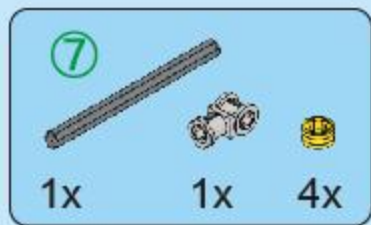

B23

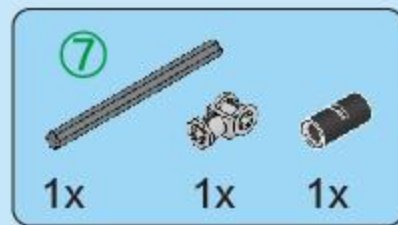
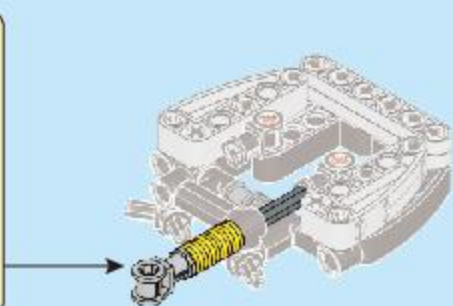
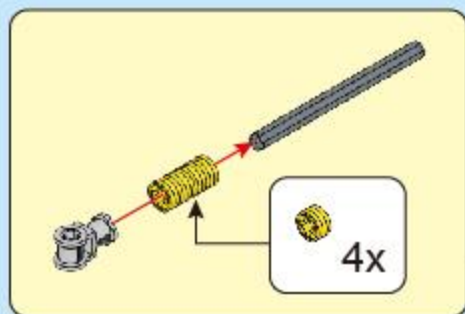

B24

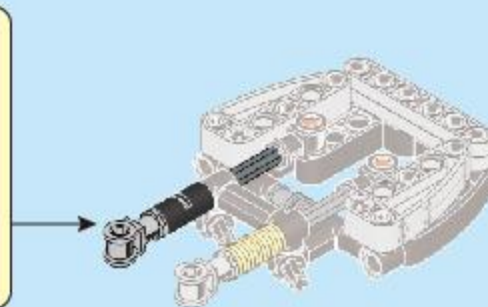
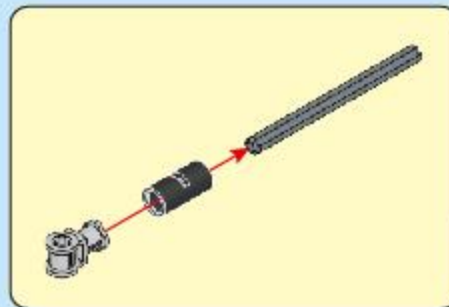

B25

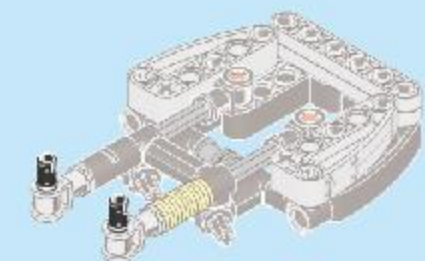

B26

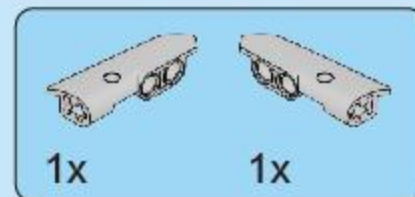
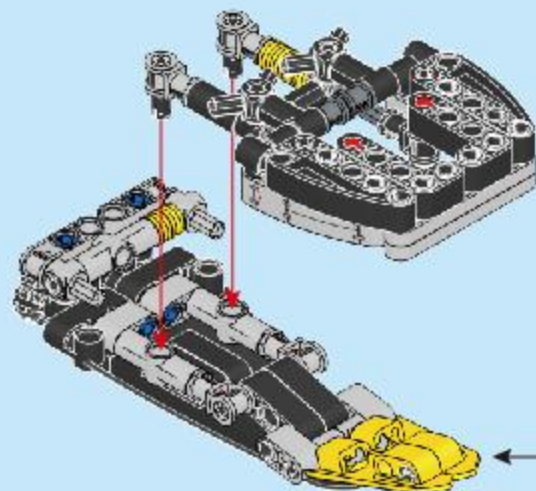

B27

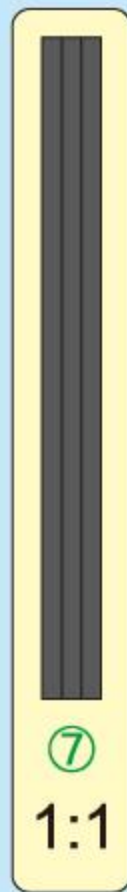
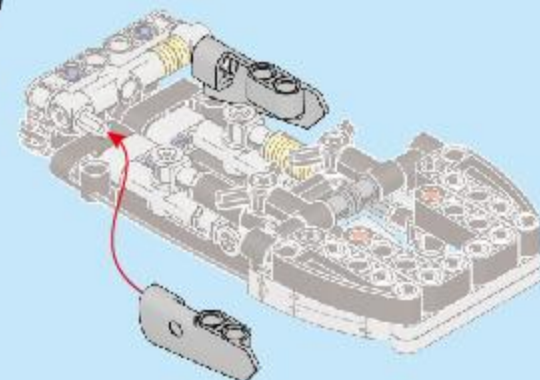

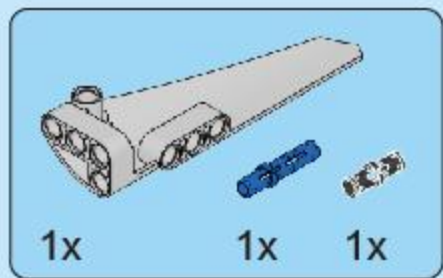

B28

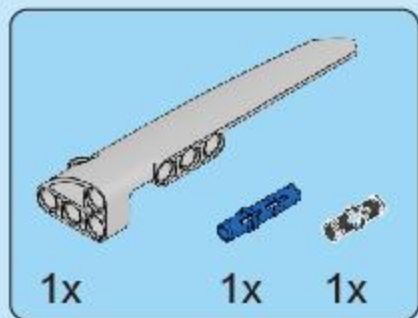
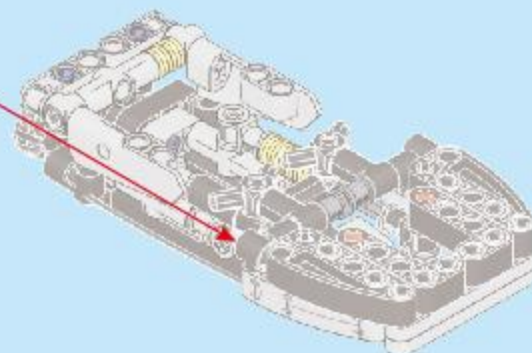
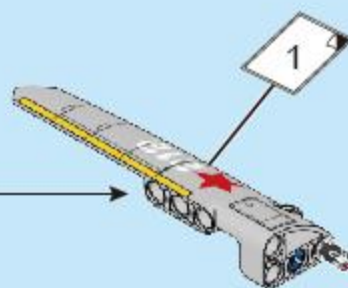
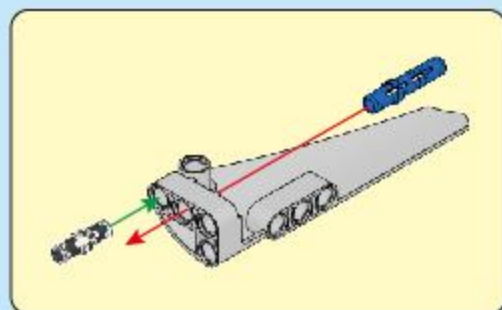

B29

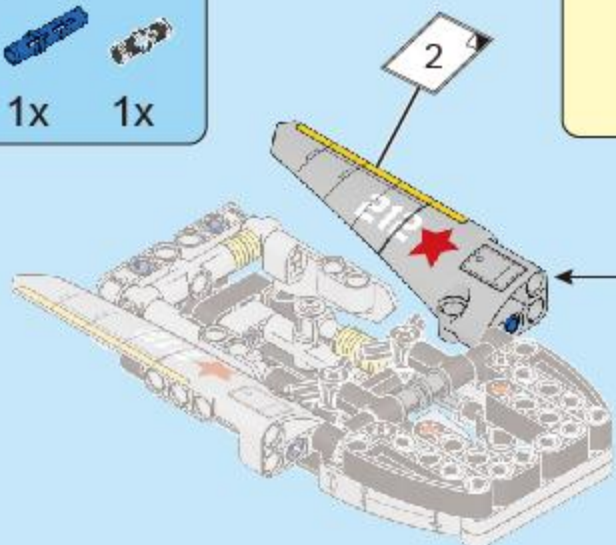
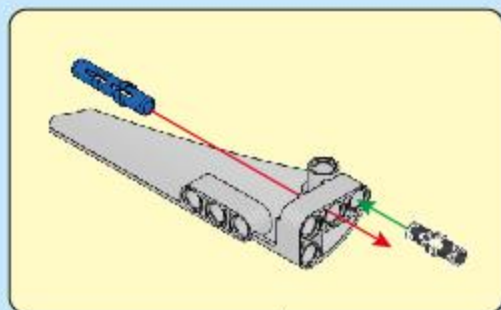

B30

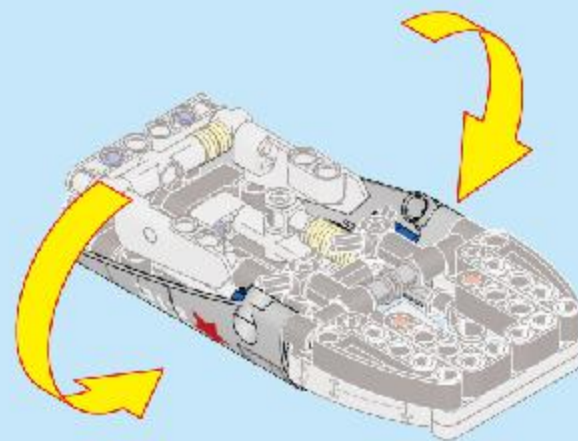



B31

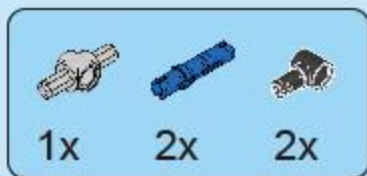

B32

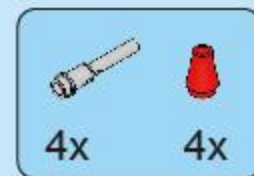

B33

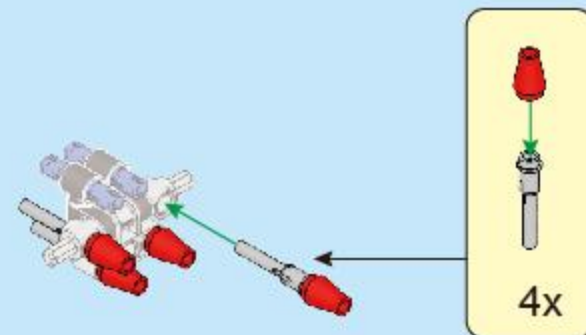
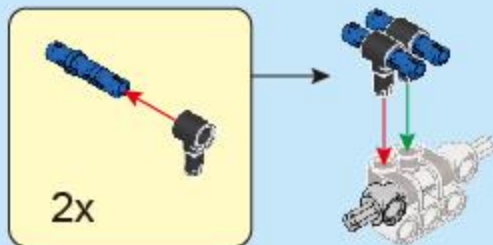
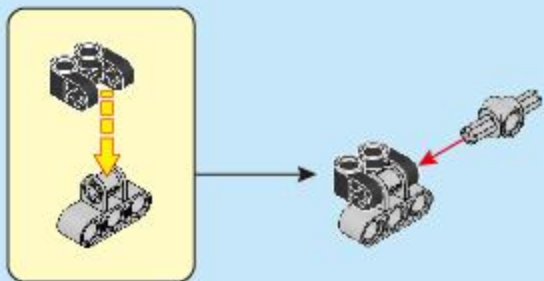

B34

B33



B30

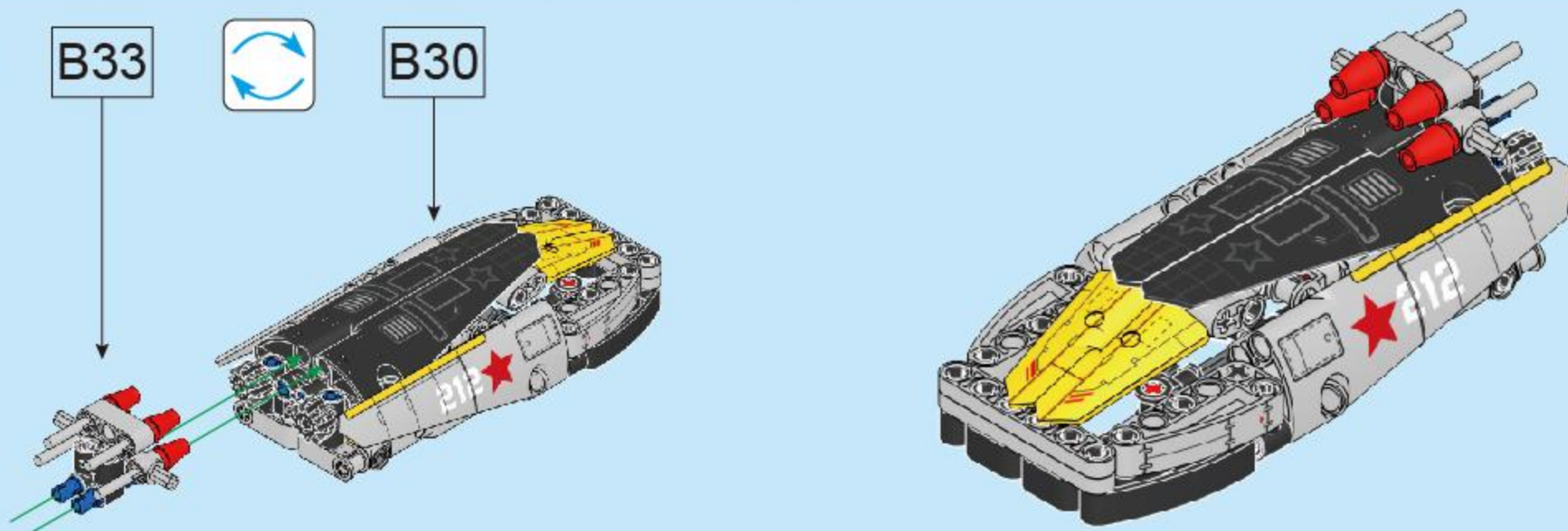

ENGINE-MORPH



2in1

