

FC3327-3



4 IN 1
ENGINEERING
CONSTRUCTION TEAM

CITY



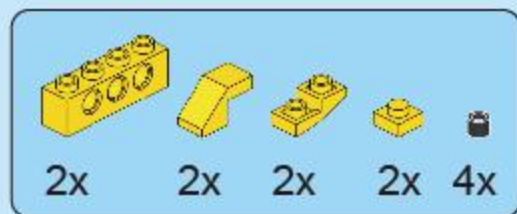
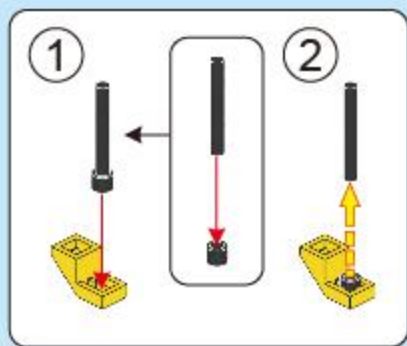

C1

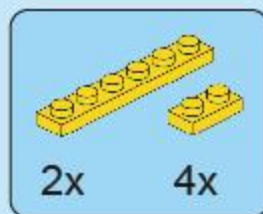

C2

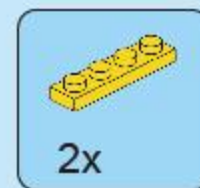

C3

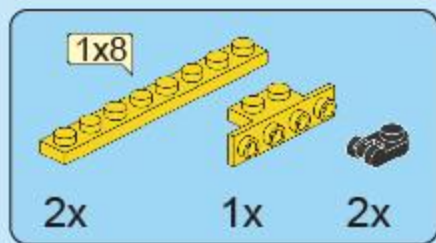
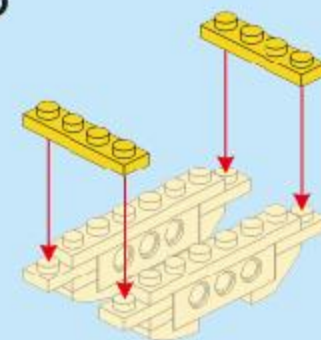
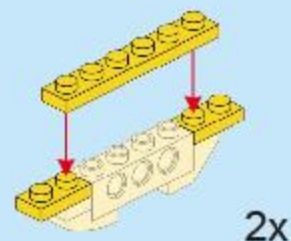
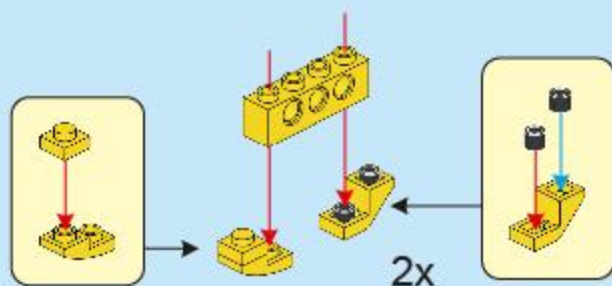

C4

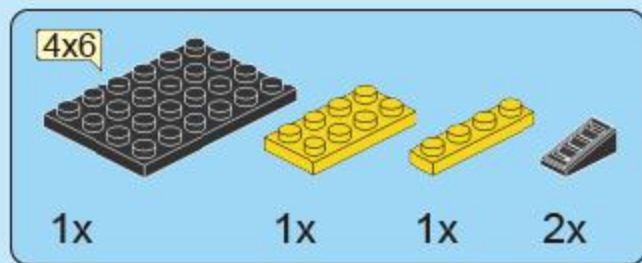

C5

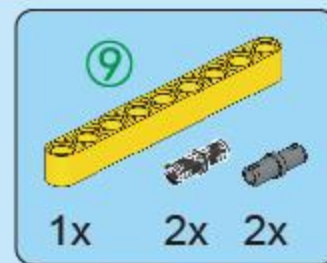

C6

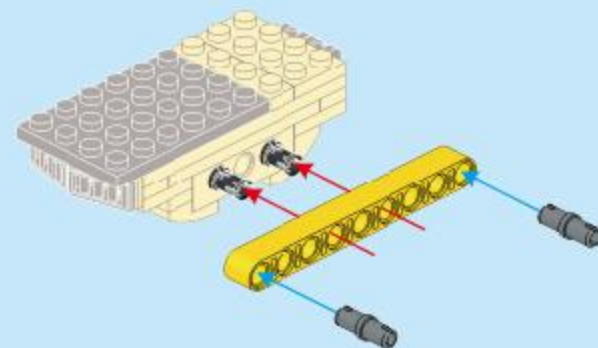
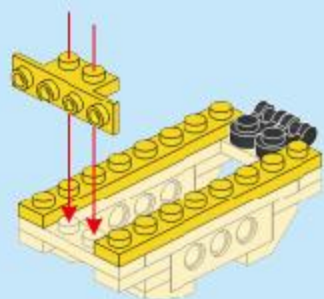

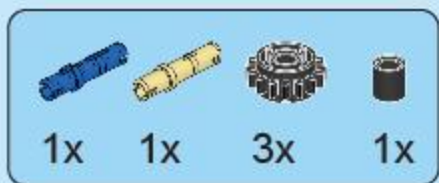

C7

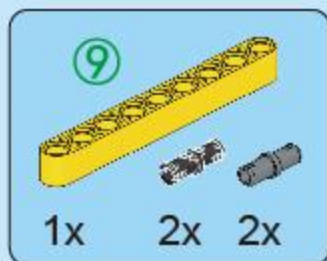
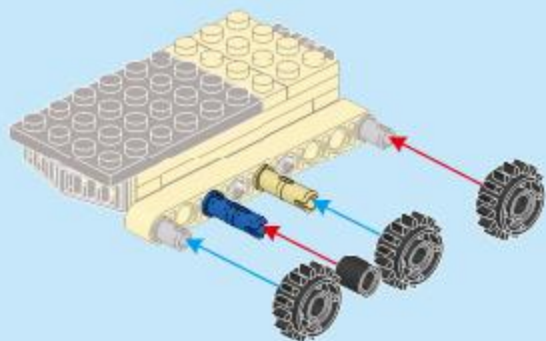

C8

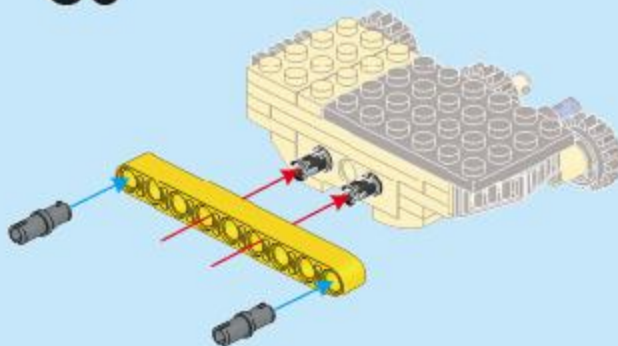

C9

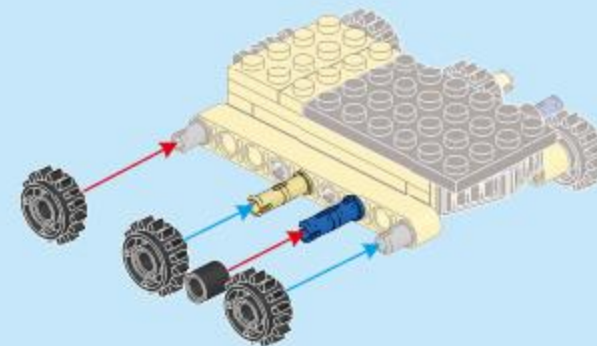

C10

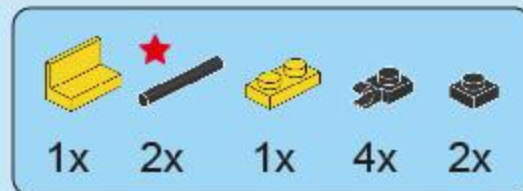
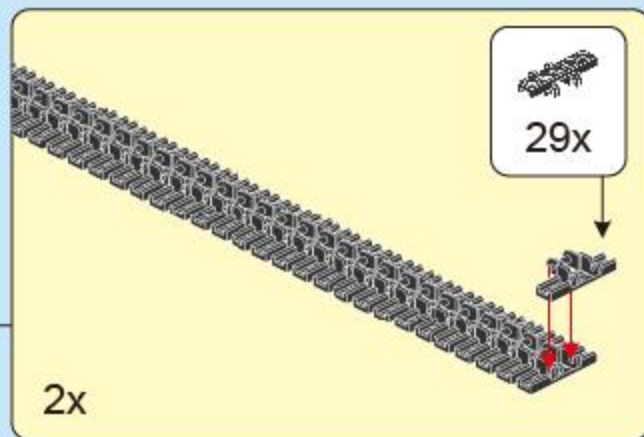
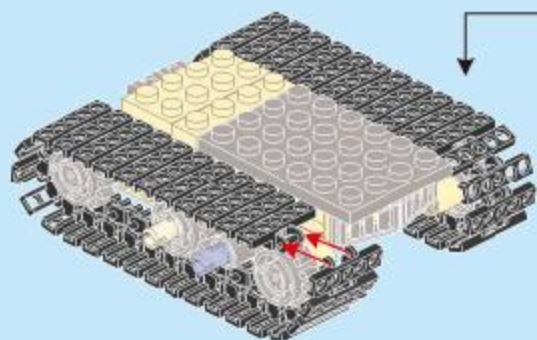

C11

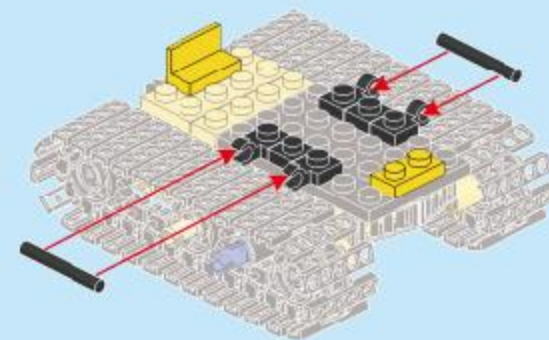

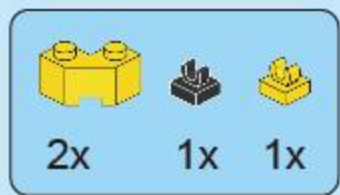

C12

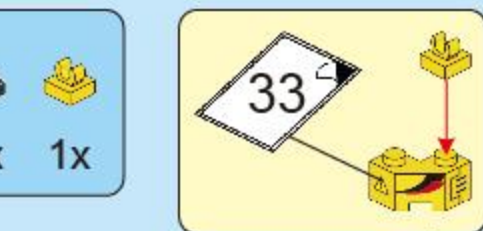

C13

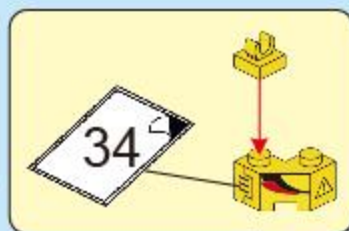
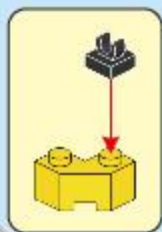

C14

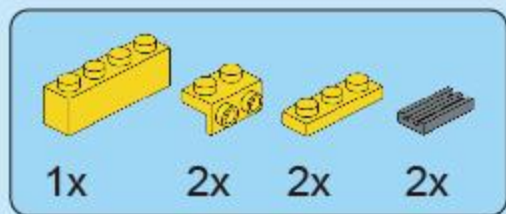
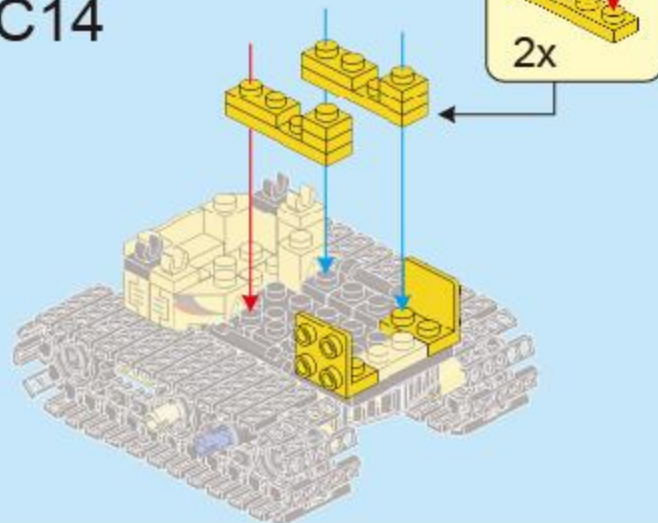

C15

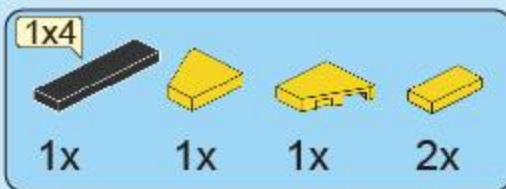
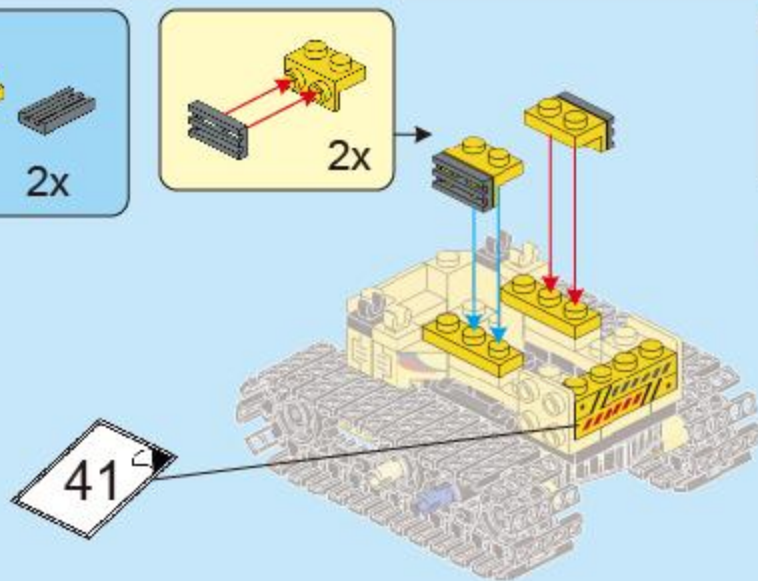

C16

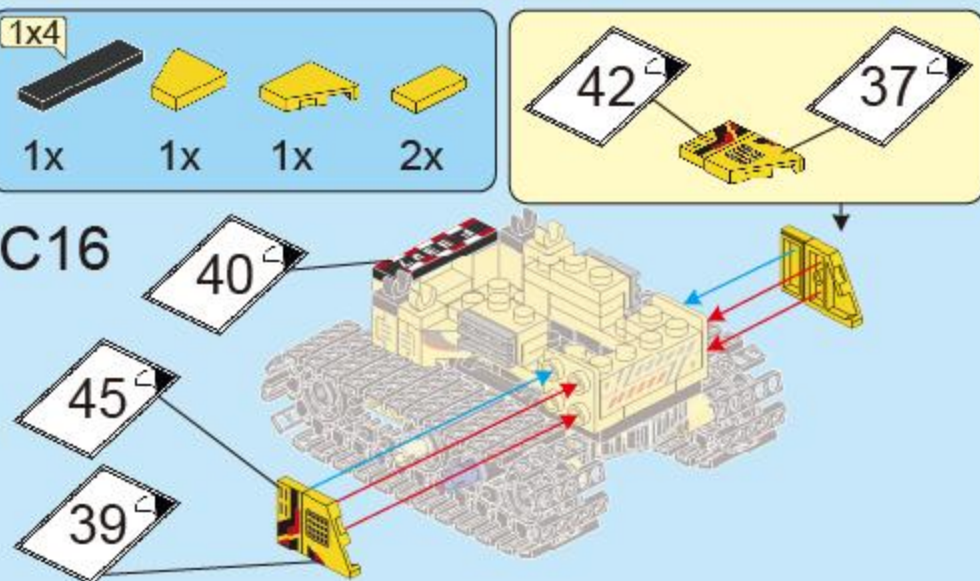



C17

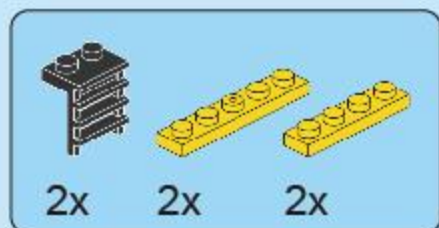
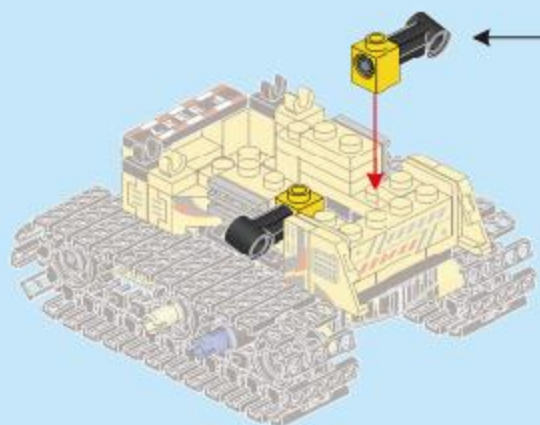
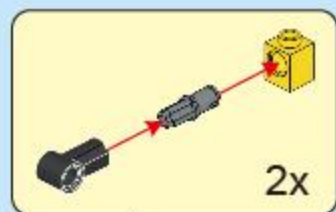

C18

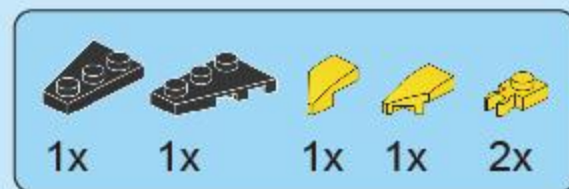
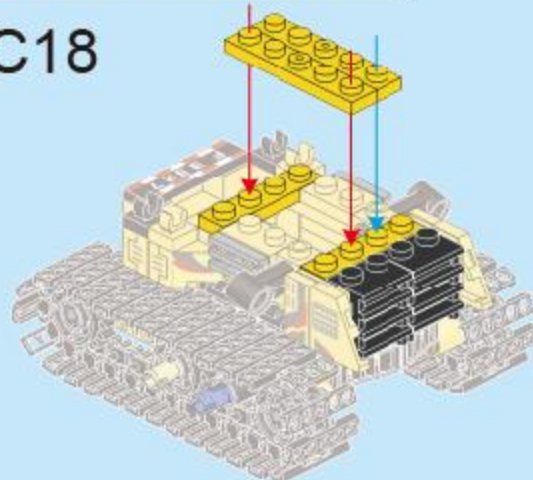

C19

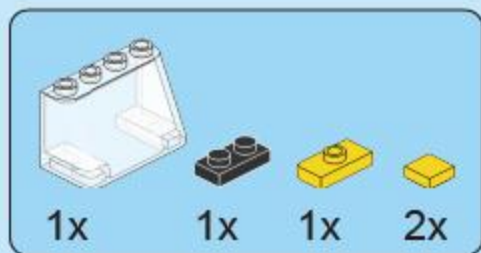

C20

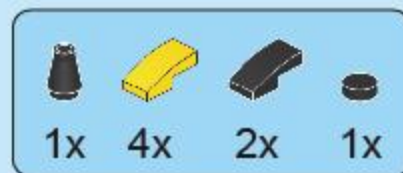
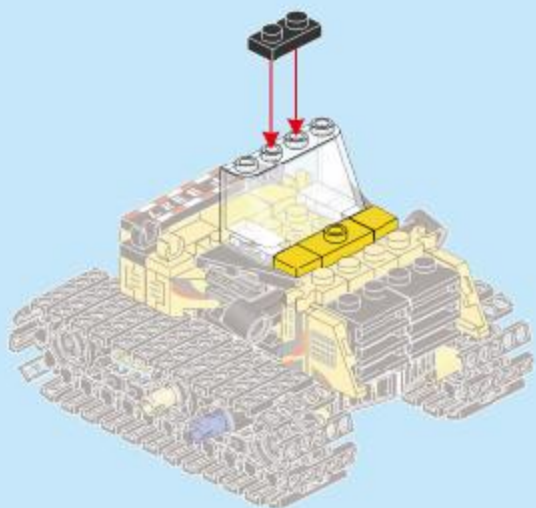

C21

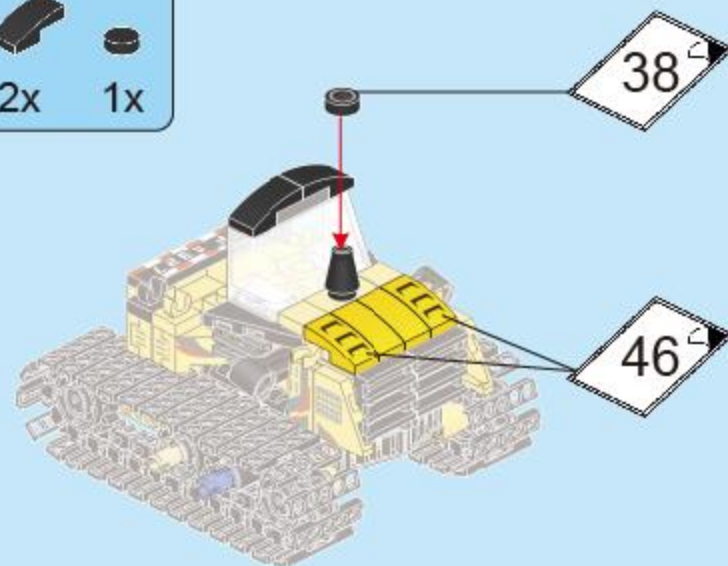



C22

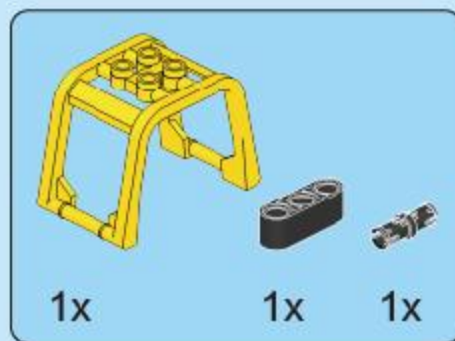
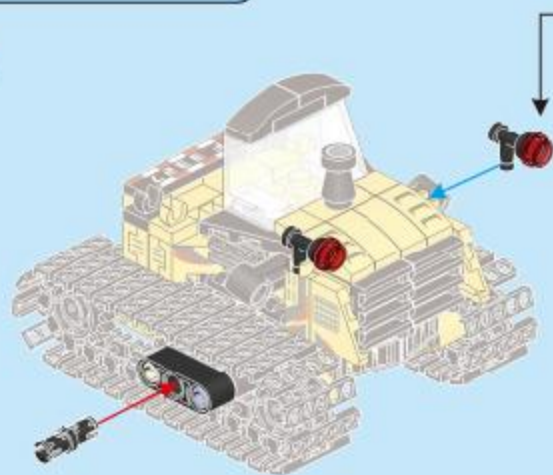

C23

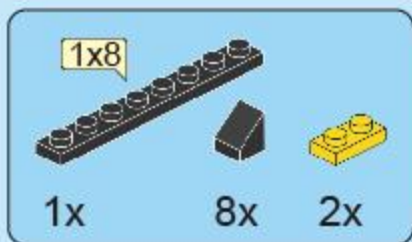
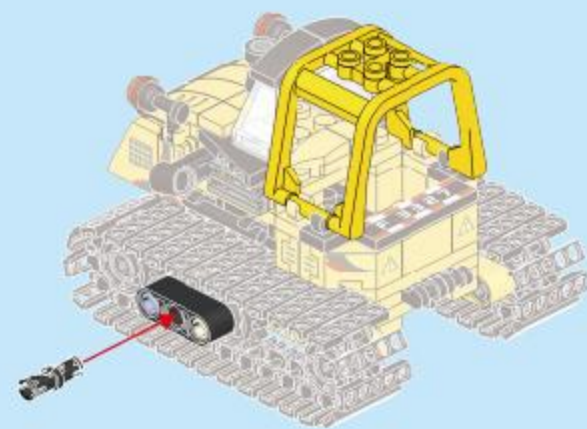

C24

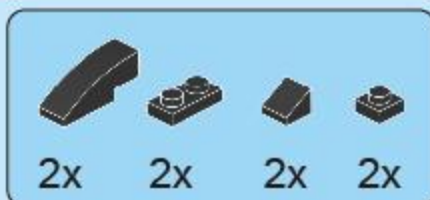
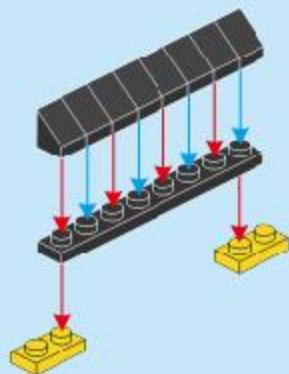

C25

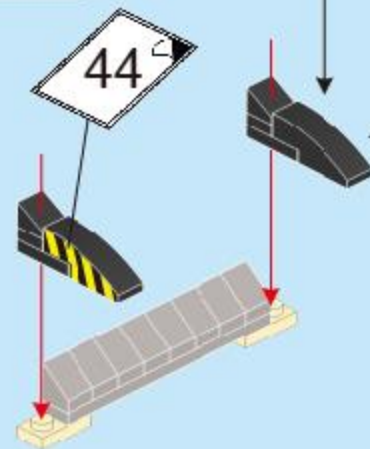
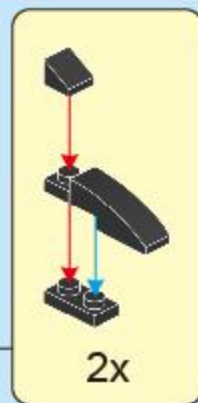
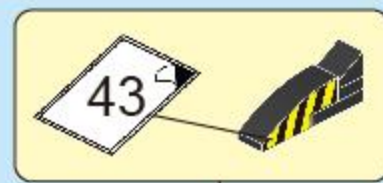

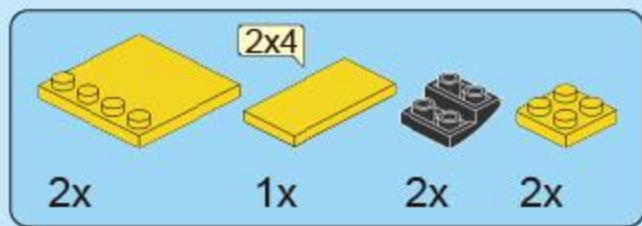

C26

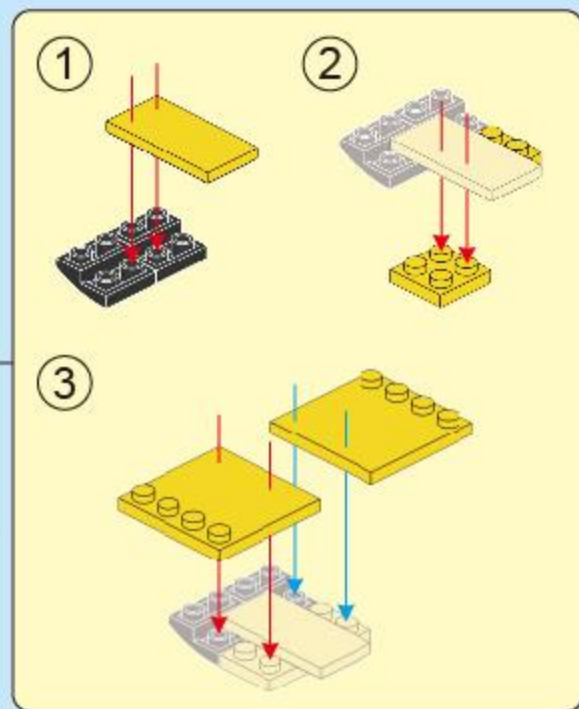
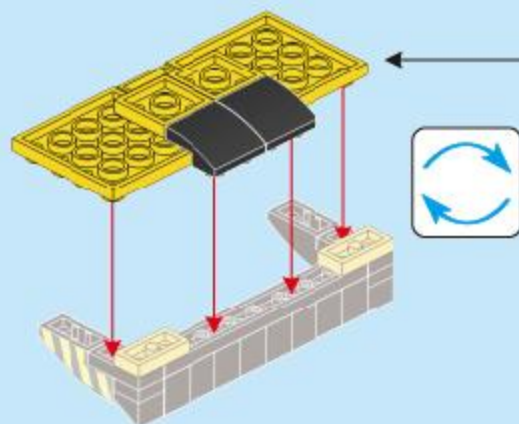

C27

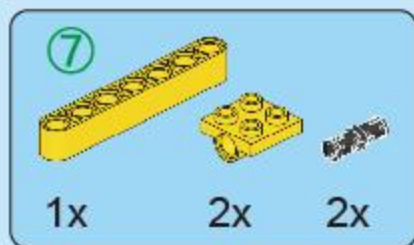
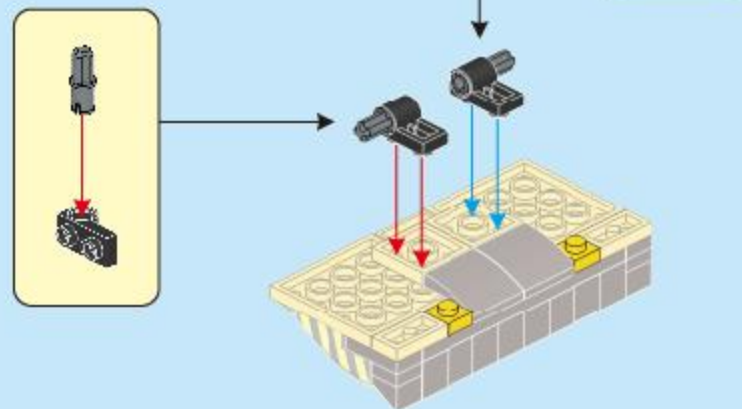

C28

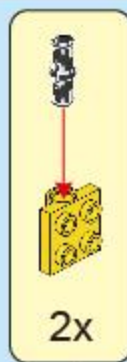
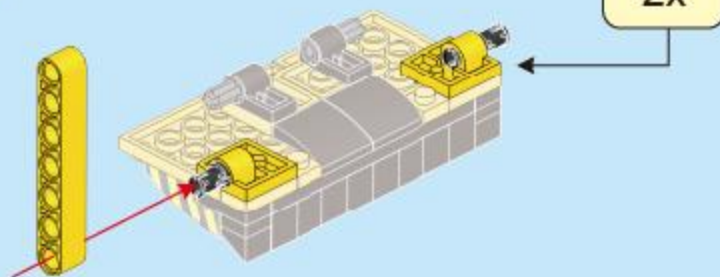

C29

C28

C23

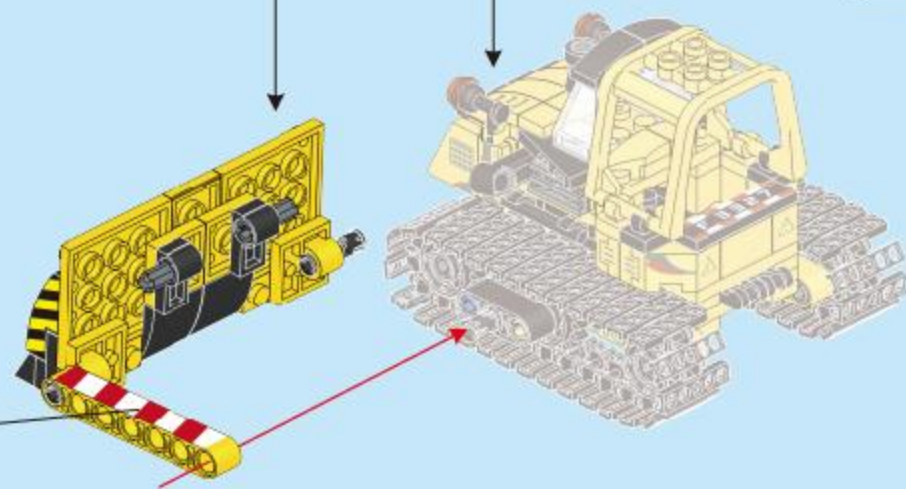



C30

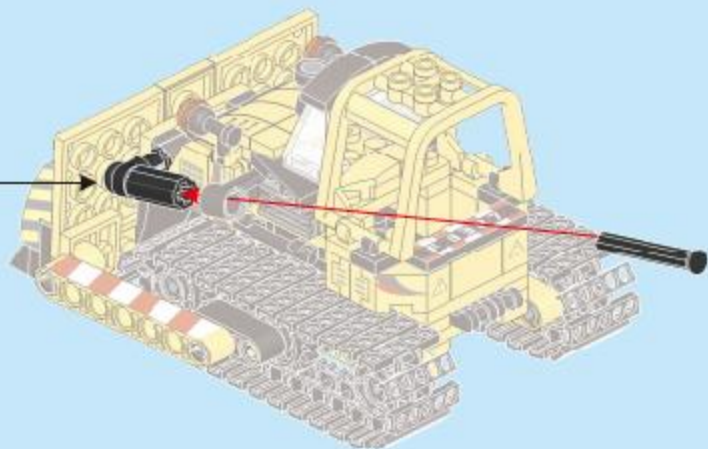
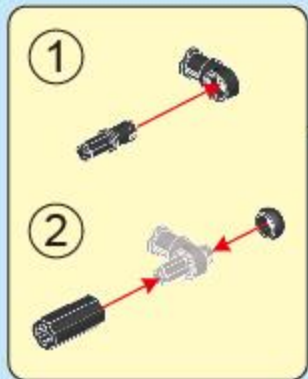

C31

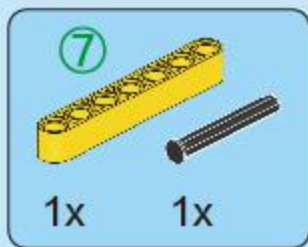
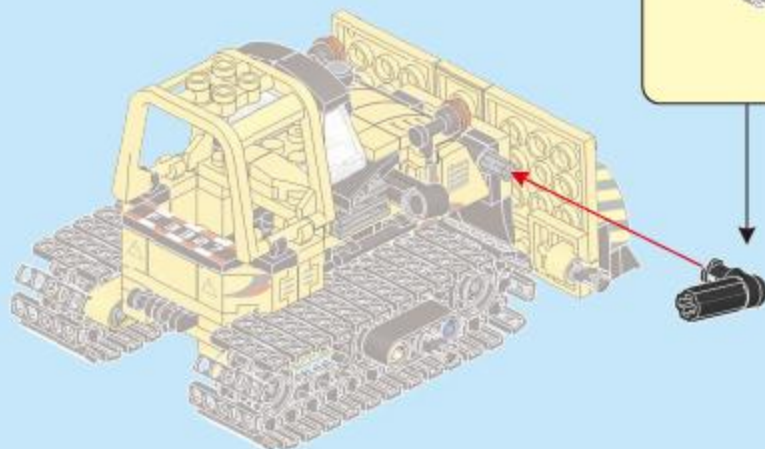
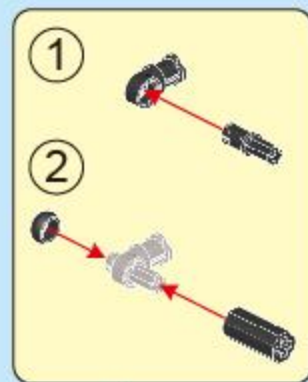

C32

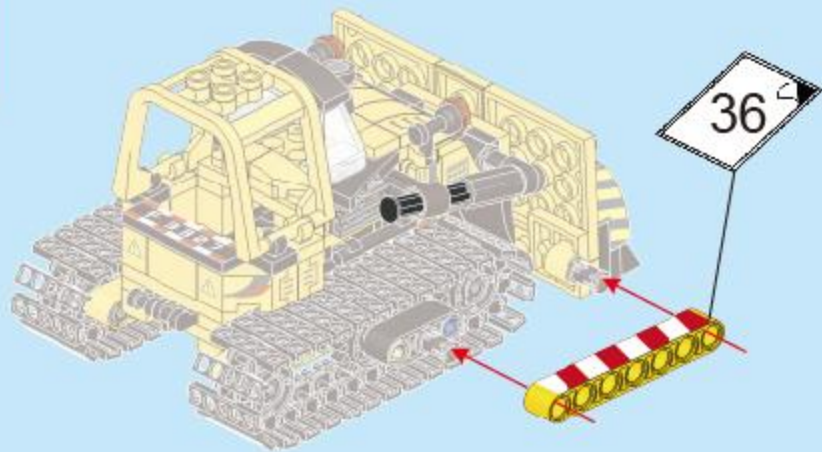

C



4IN1



56

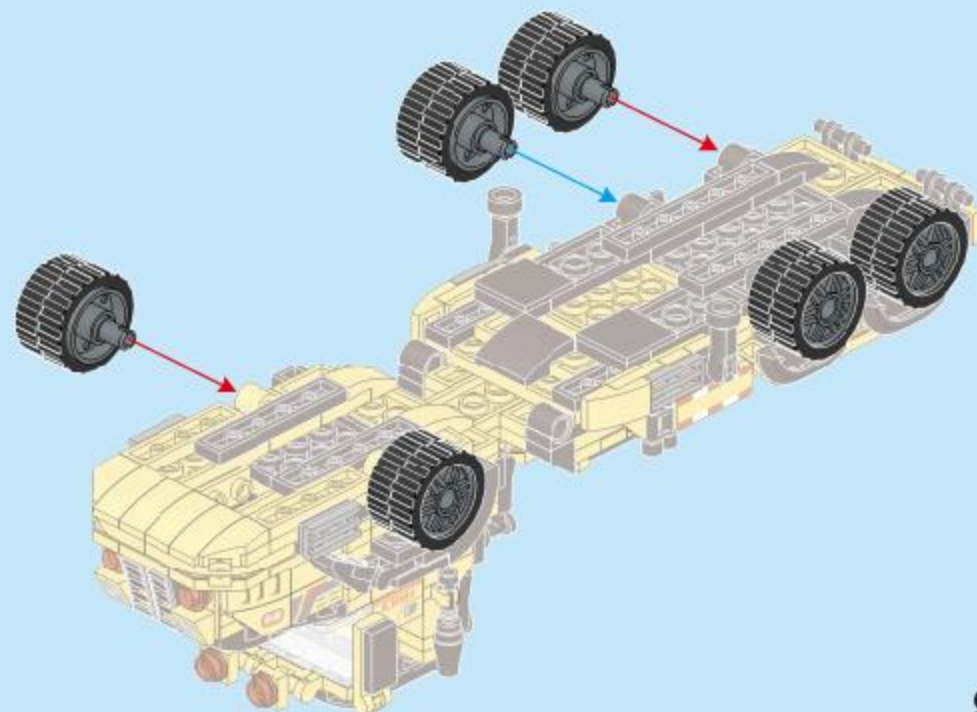
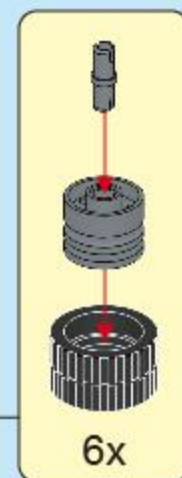

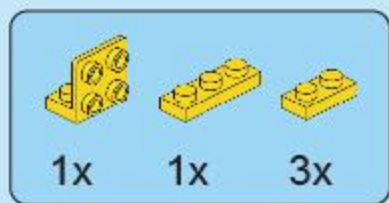

57

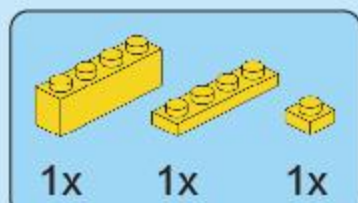
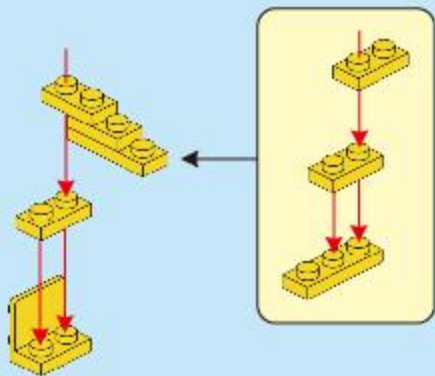

58

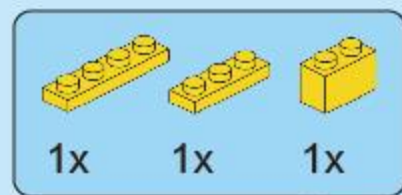
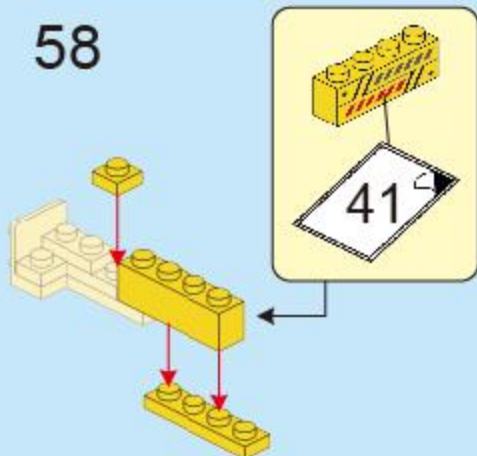

59

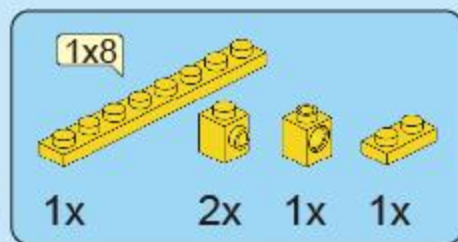
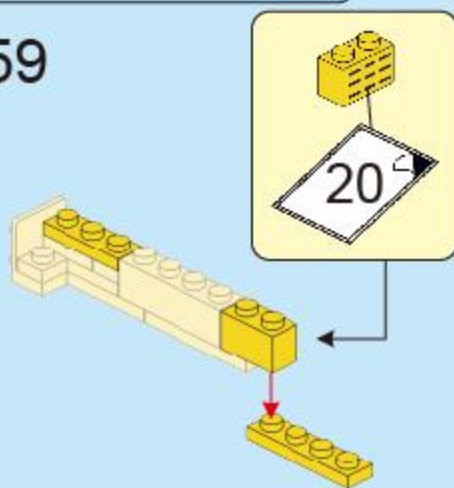

60

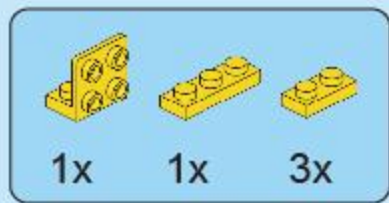
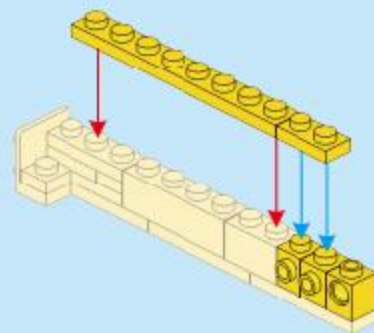

61

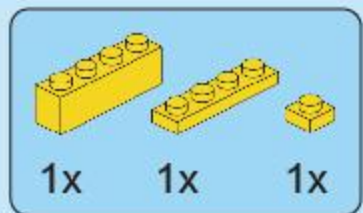
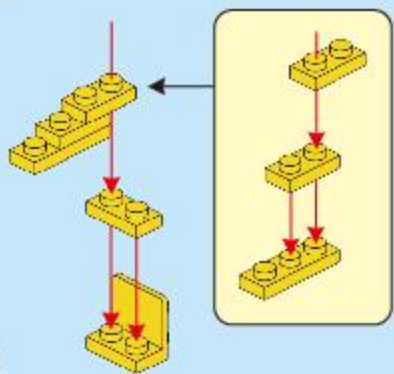

62

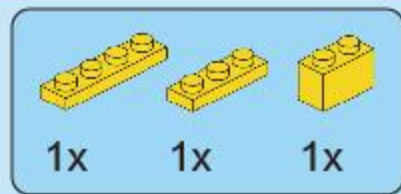
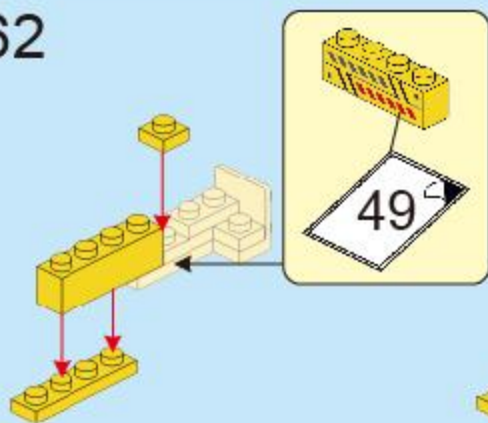

63

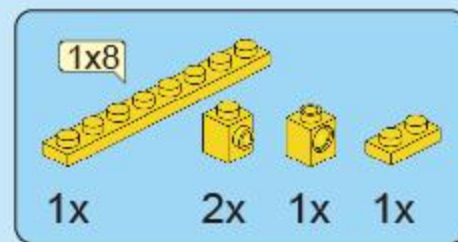
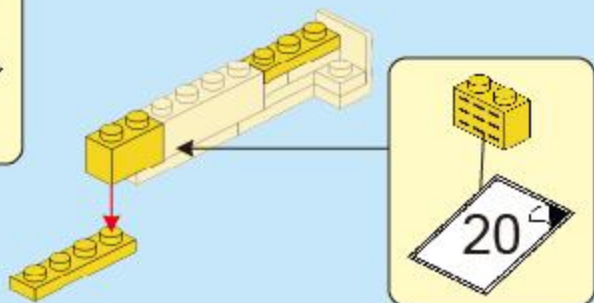

64

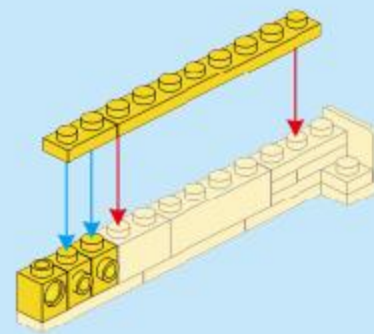

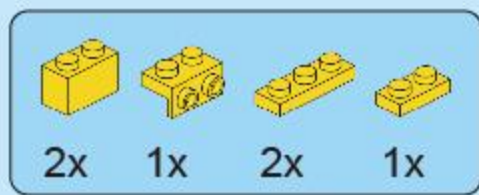

65

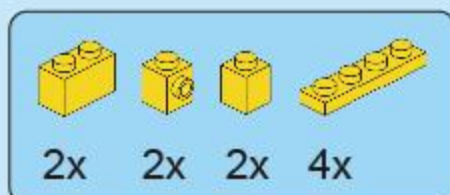
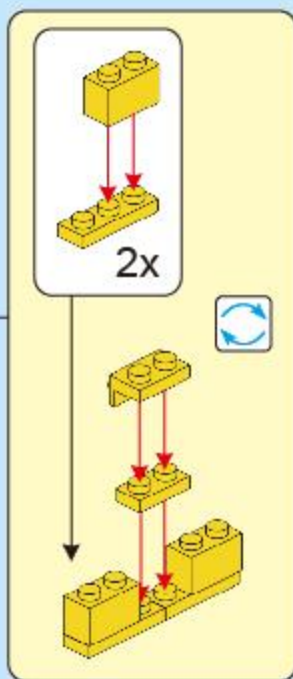
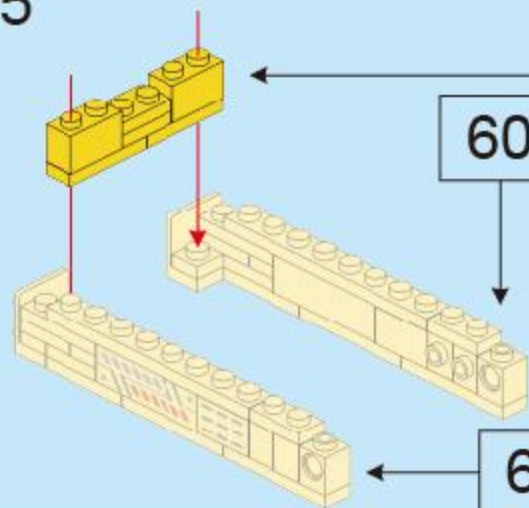

66

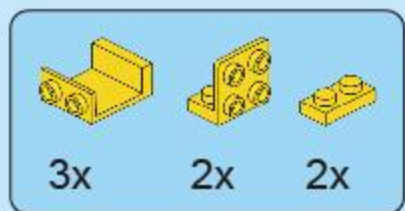
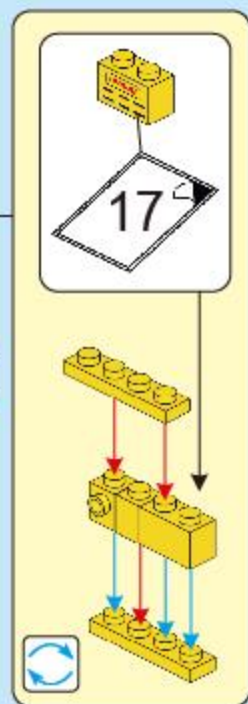
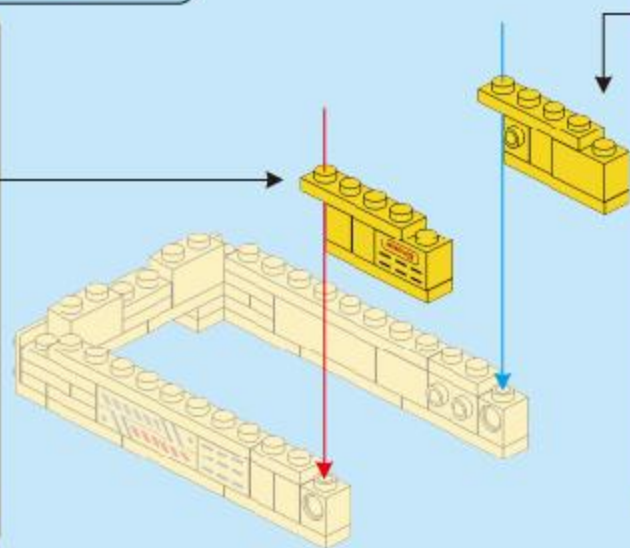
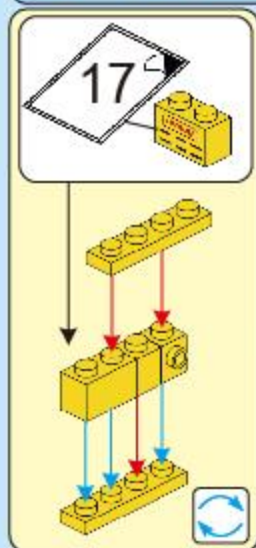

67

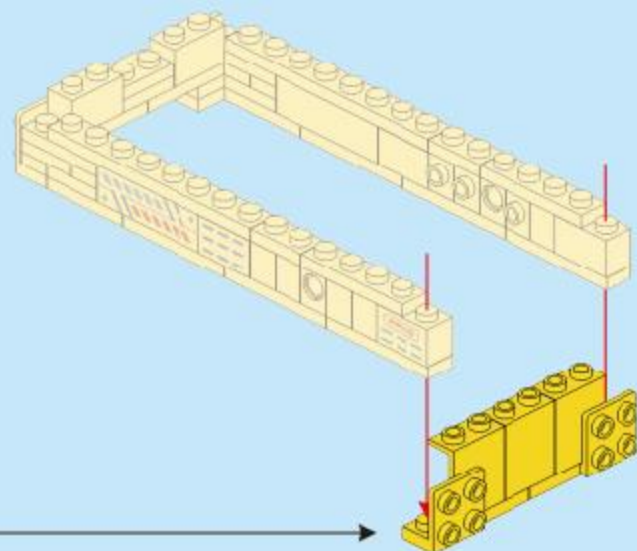
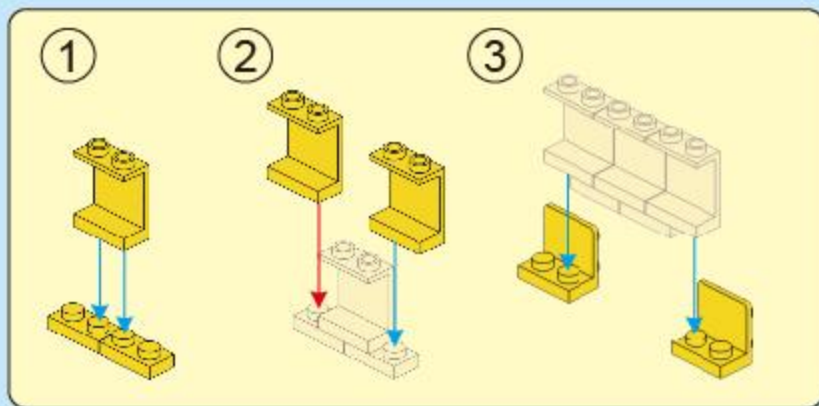

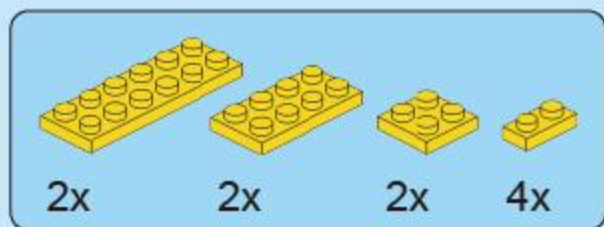

68

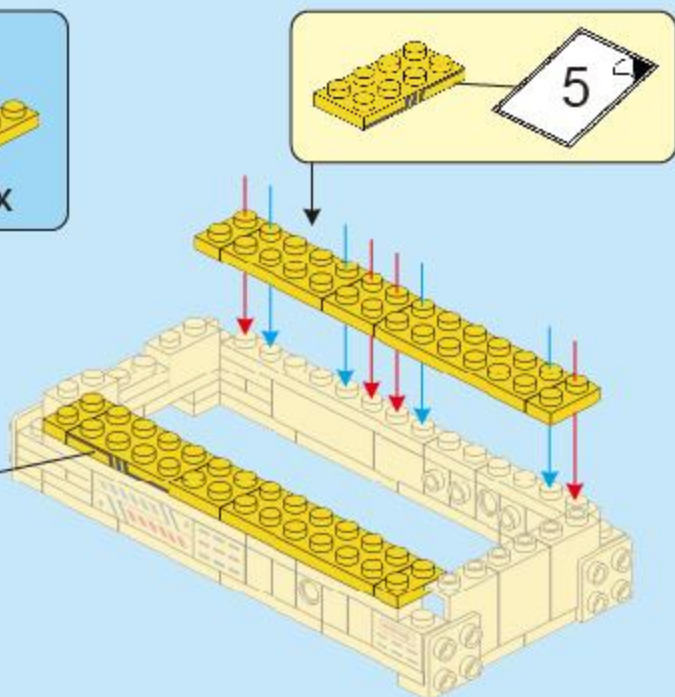

69

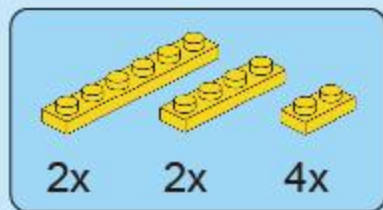
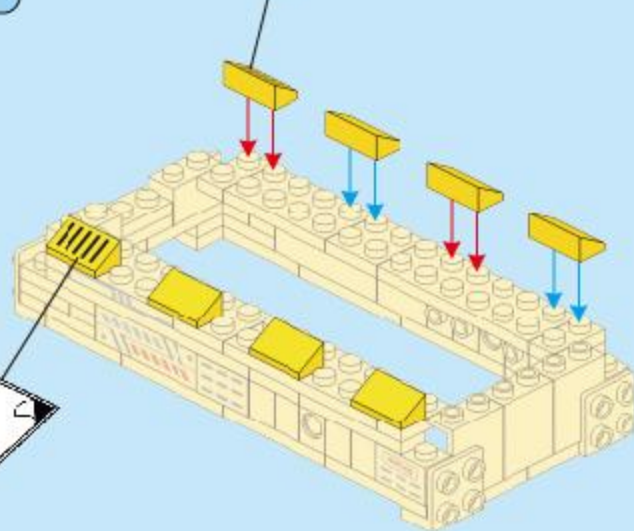

70

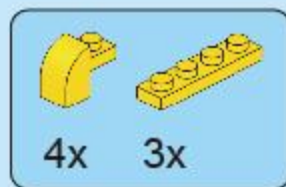
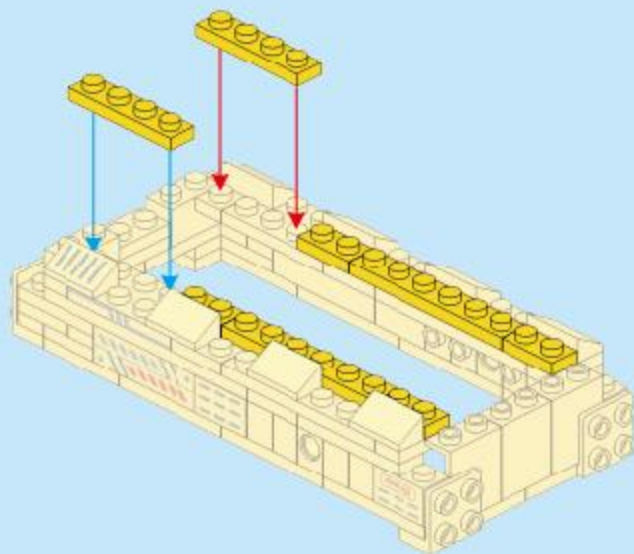

71

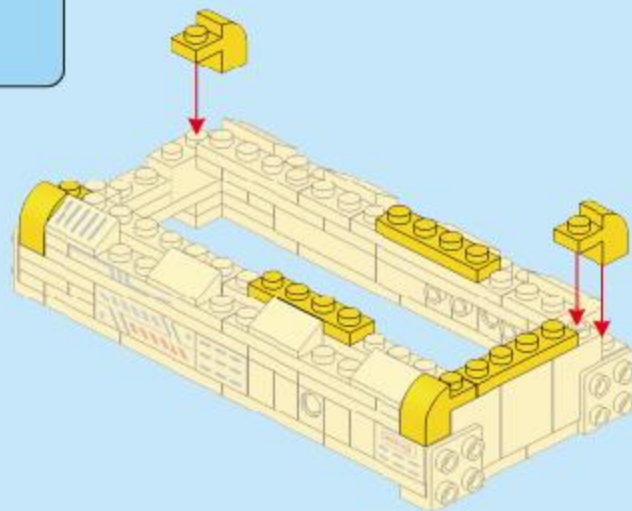

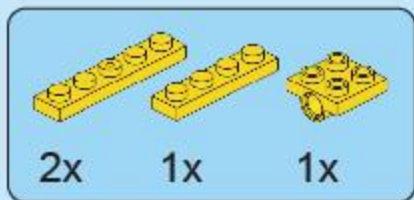

72

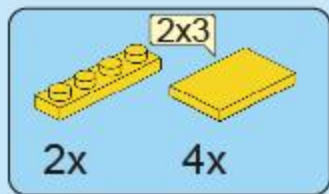
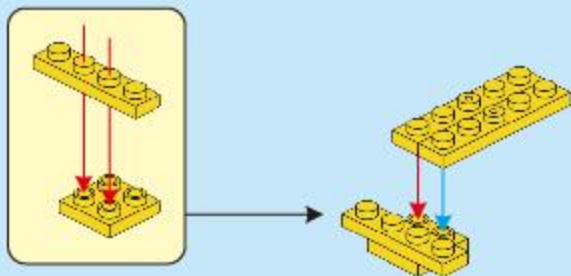

73

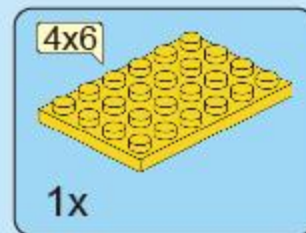
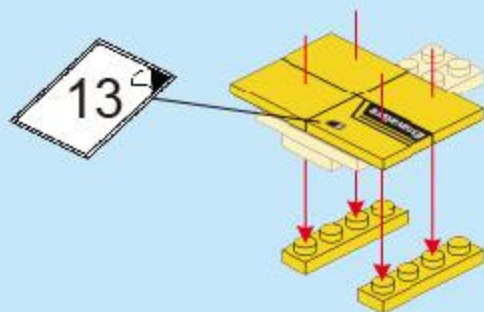

74

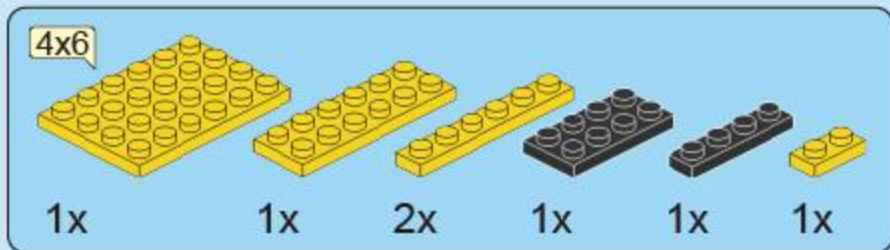
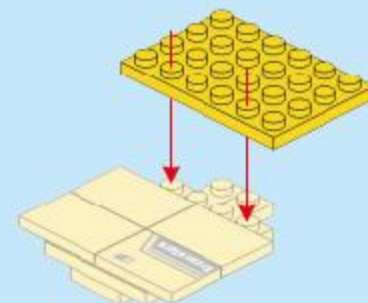

75

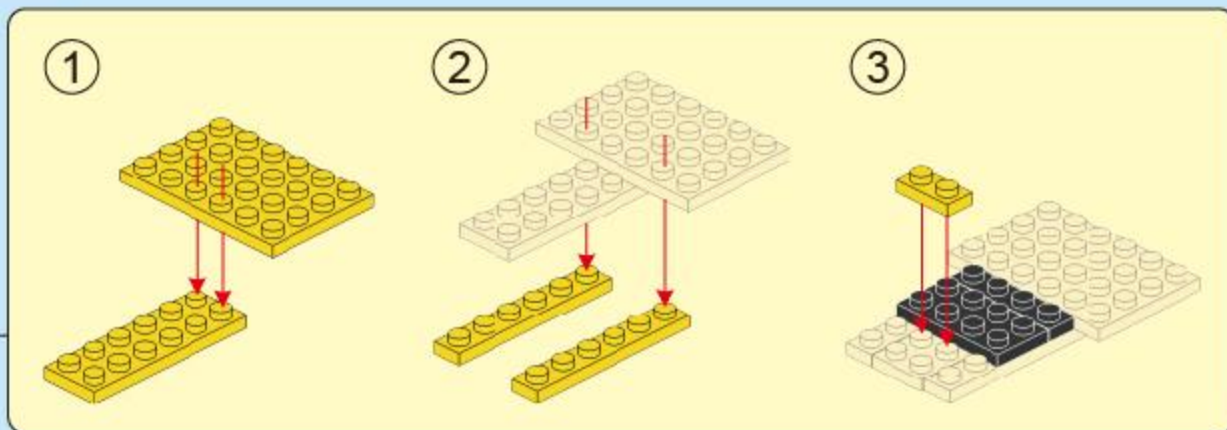
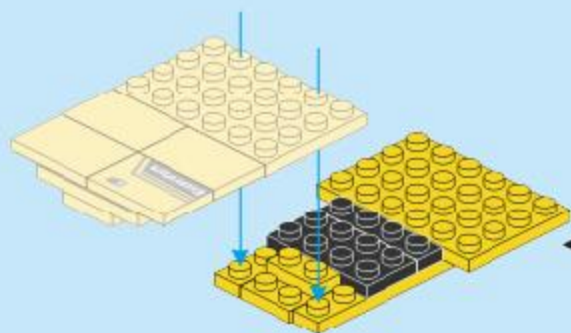

76

★  
2x 4x



★  1:1



77



75

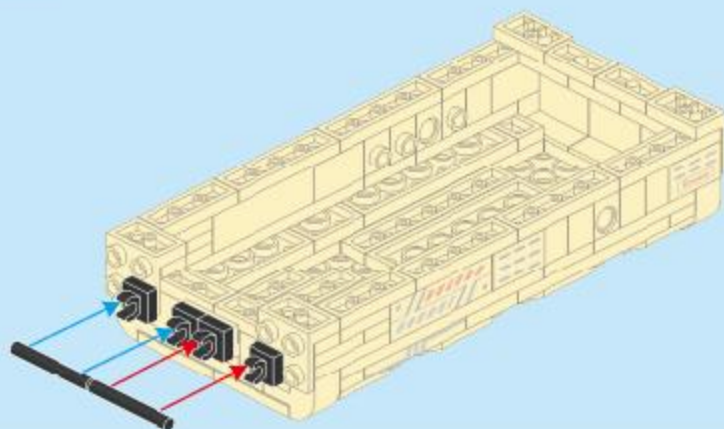
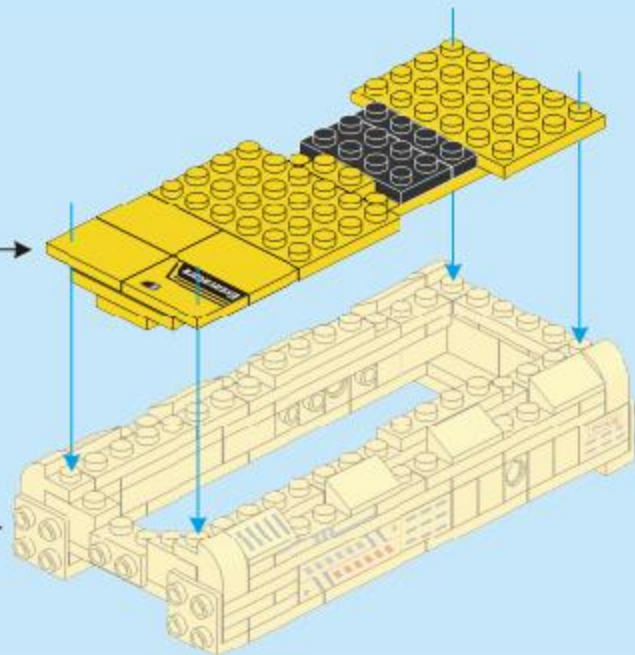

71







  
2x 2x 4x

 
2x

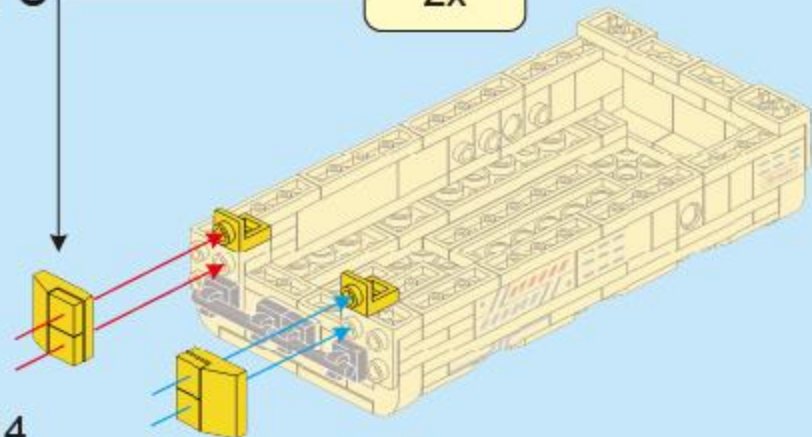

78

14



   
1x 1x 2x 2x

79



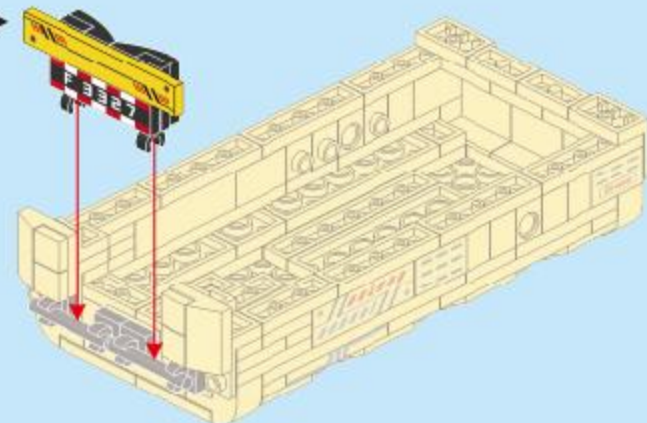

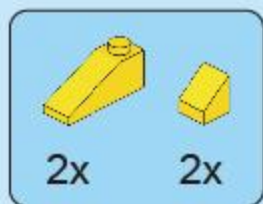
80

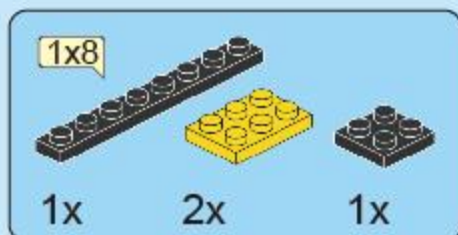
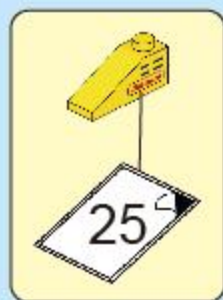
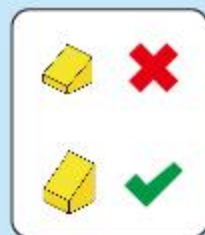

81

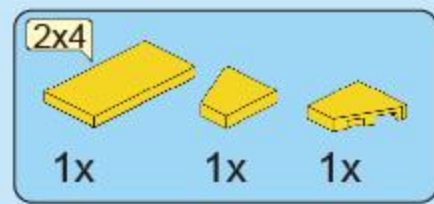

82

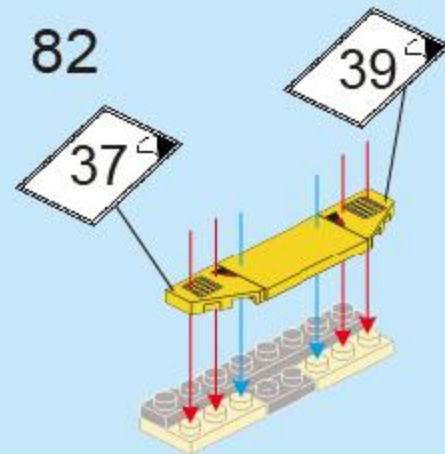
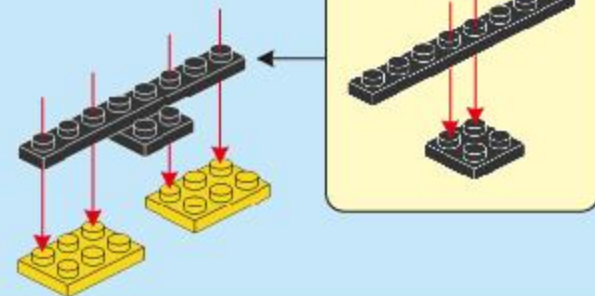
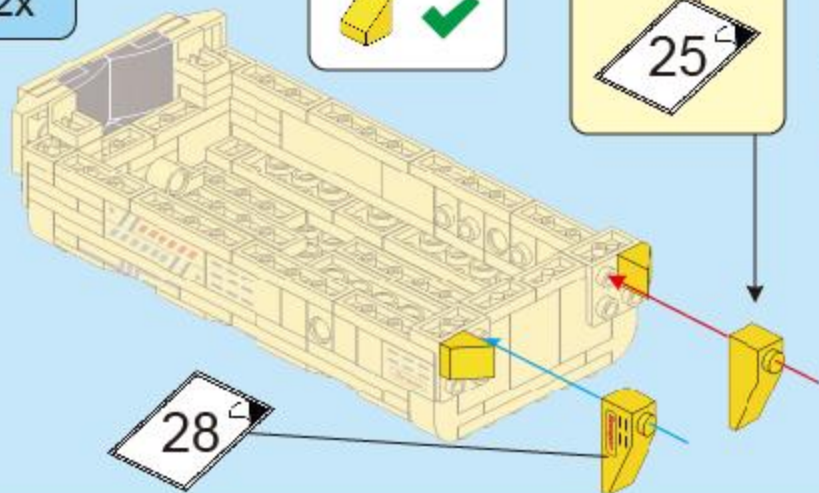

83



84

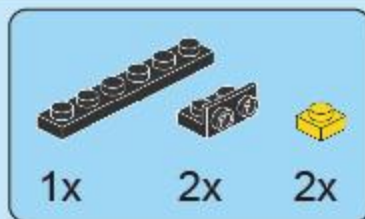

85

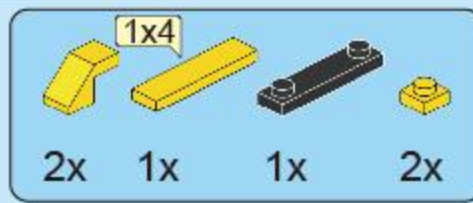

86

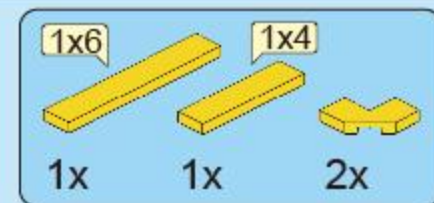

87

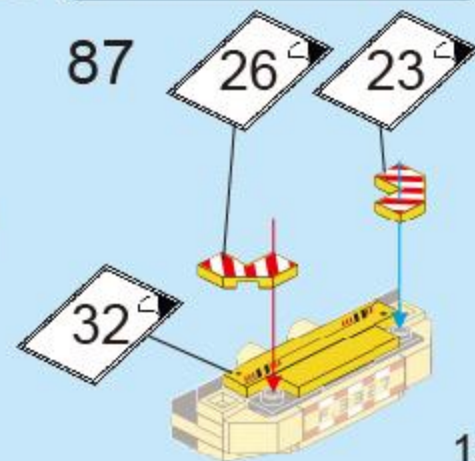
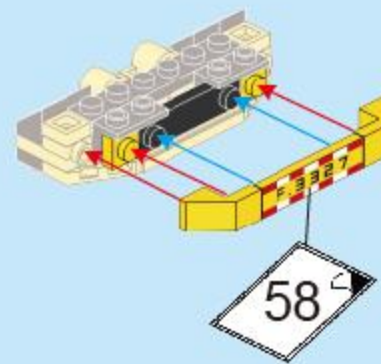
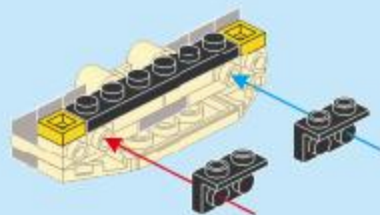
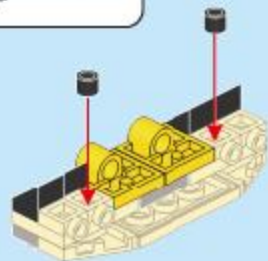
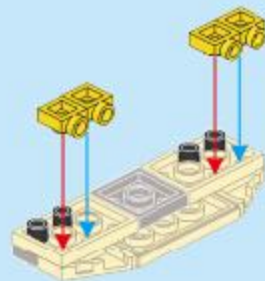

CITY

4 IN 1

