

1

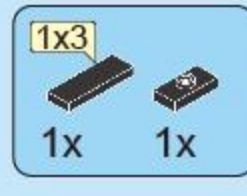

2

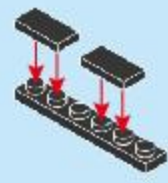
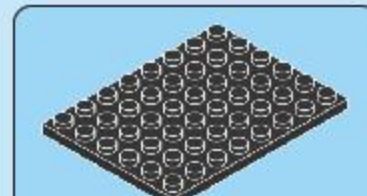

3

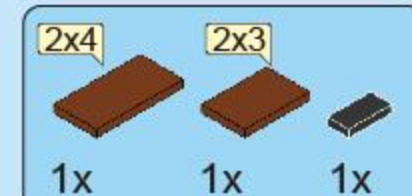
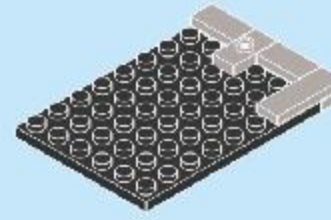

4

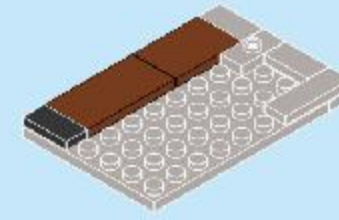

5

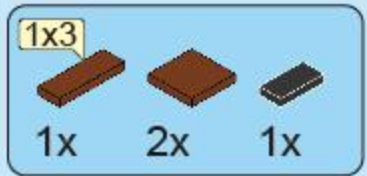
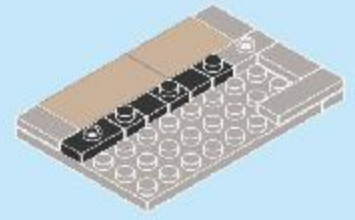

6

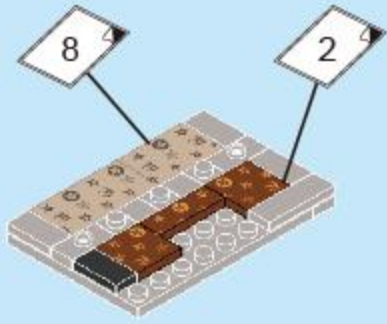

7

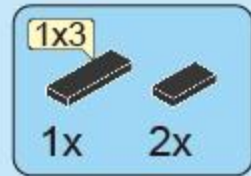
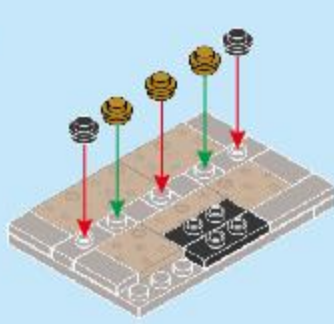

8

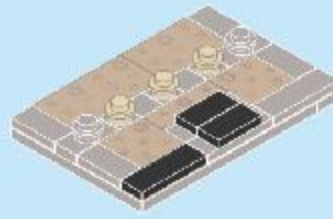

9



10

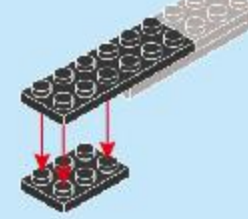

11

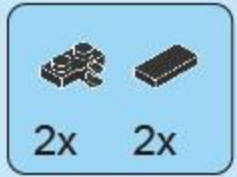
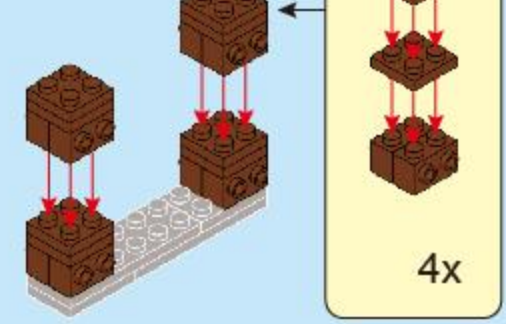

12

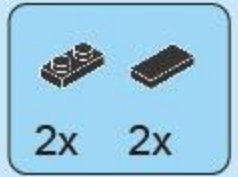
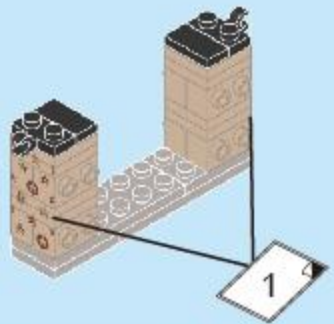

13

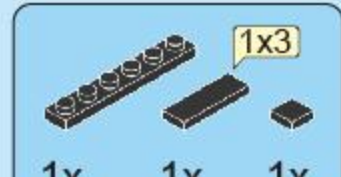
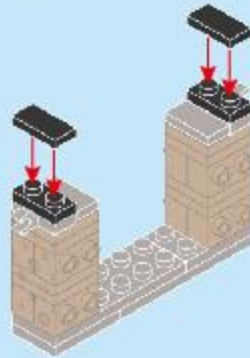

14

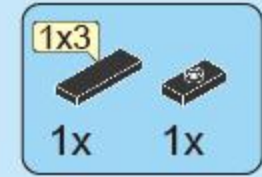
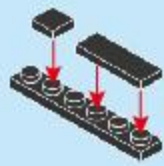

15



16

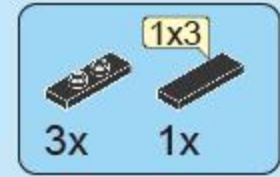
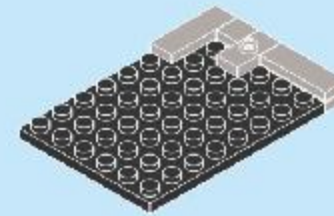

17

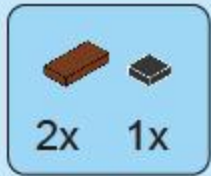
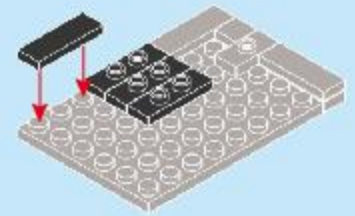

18

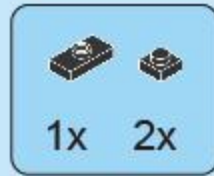
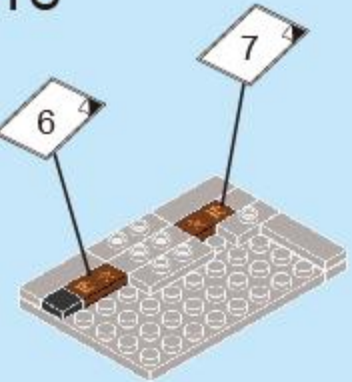

19

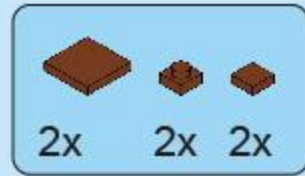
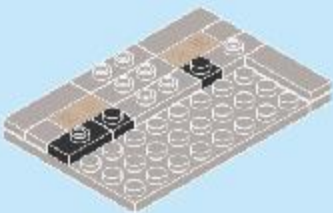

20

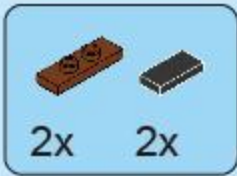
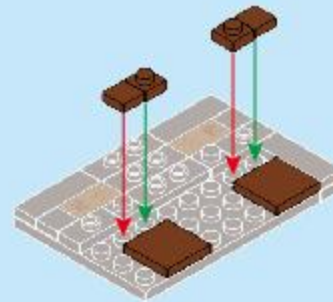

21

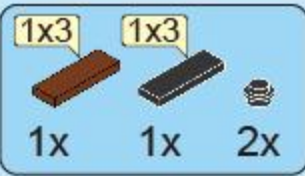
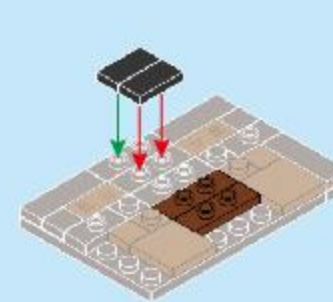

22

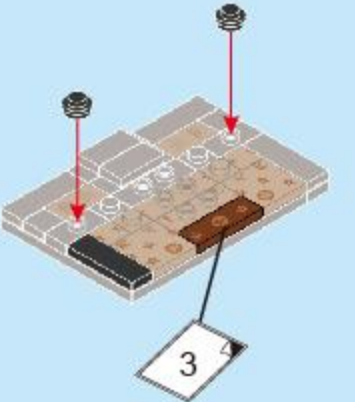

23

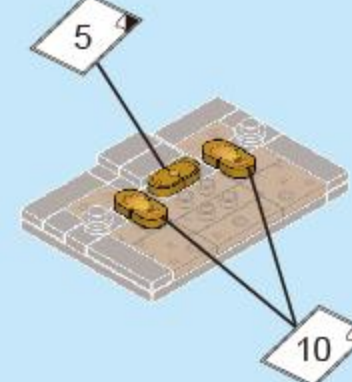

24

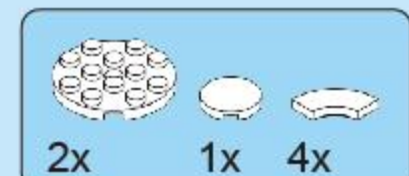
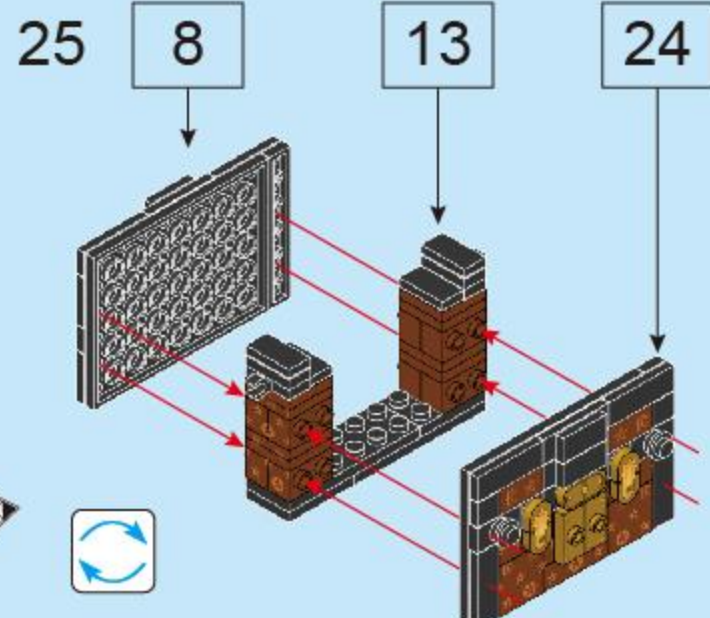
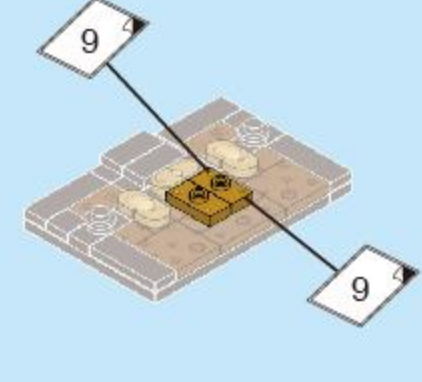

26

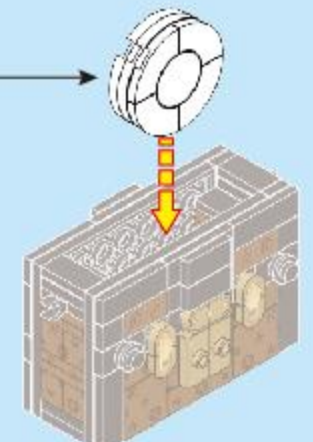
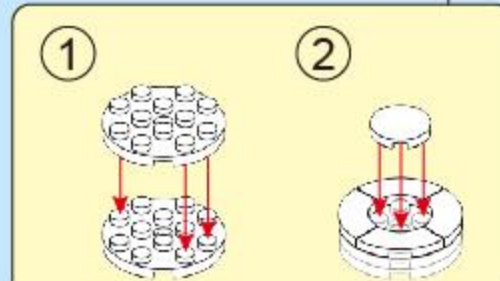

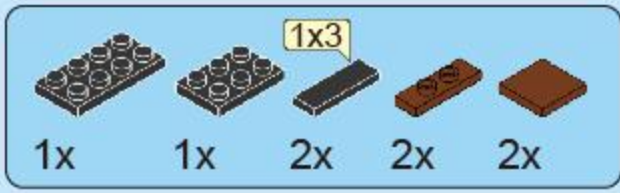

27

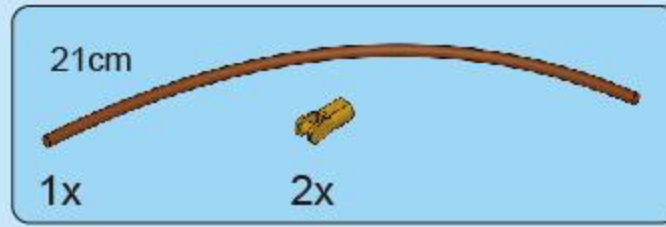
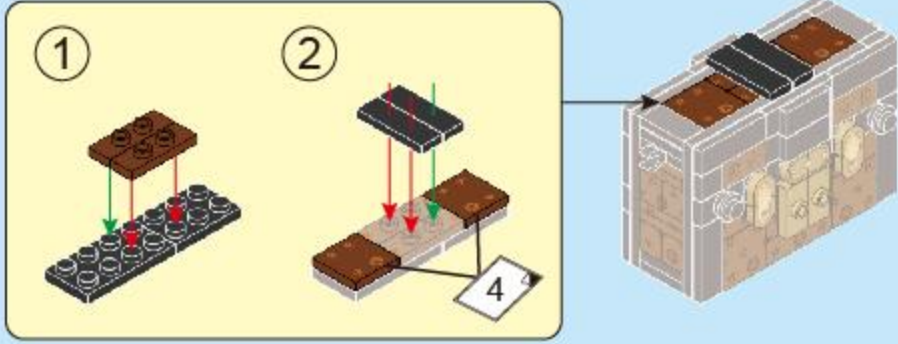

28

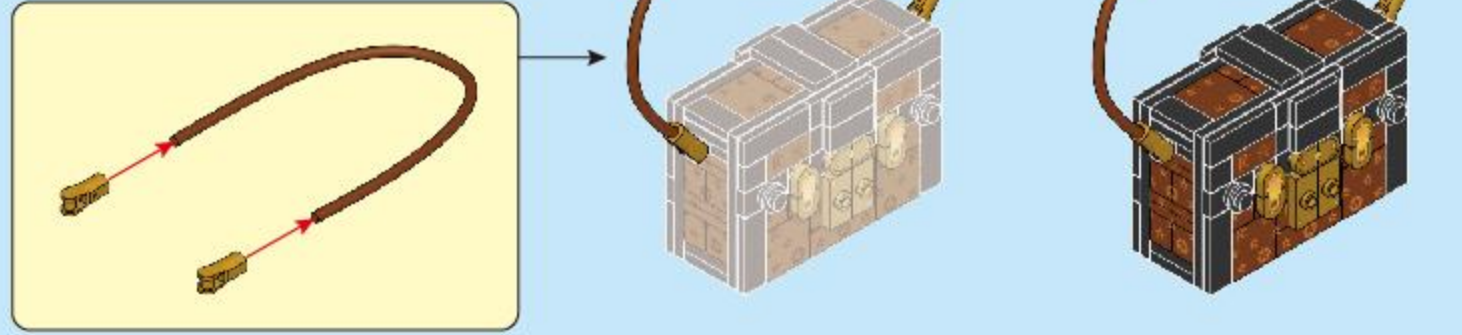

A



B

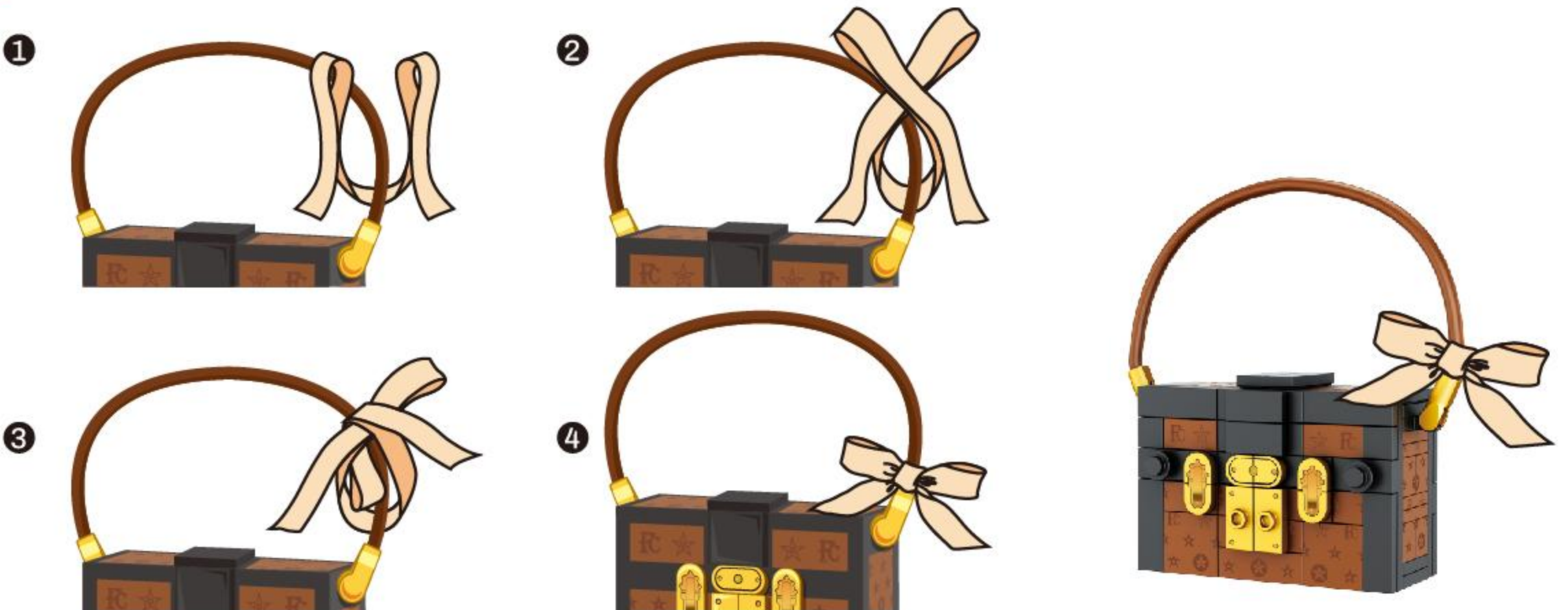

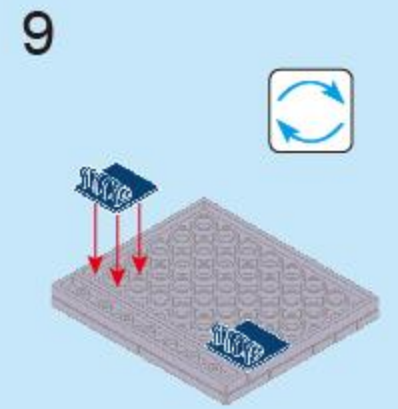
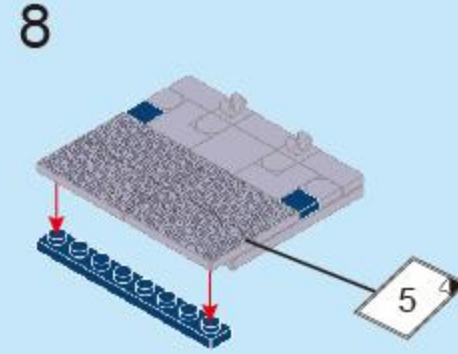
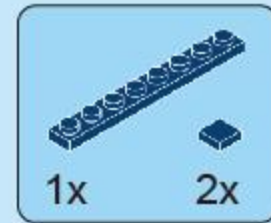
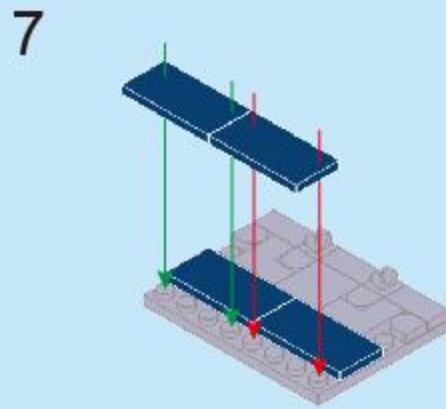
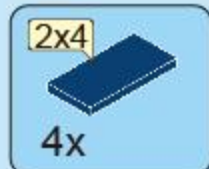
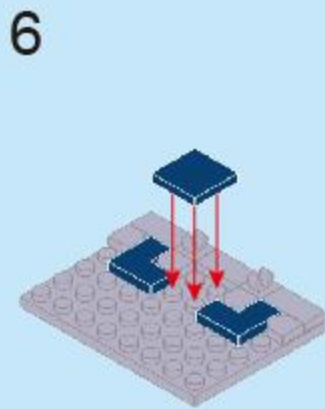
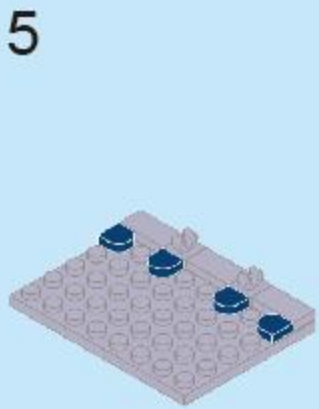
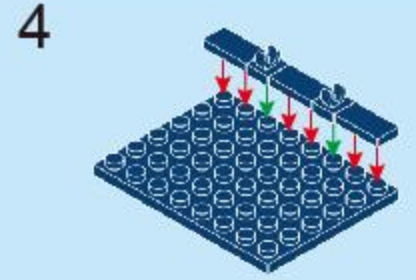
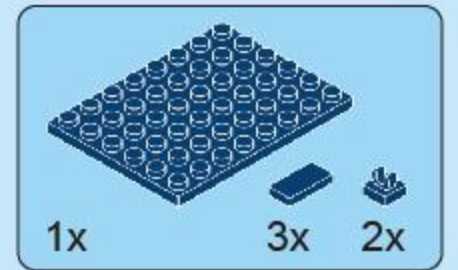
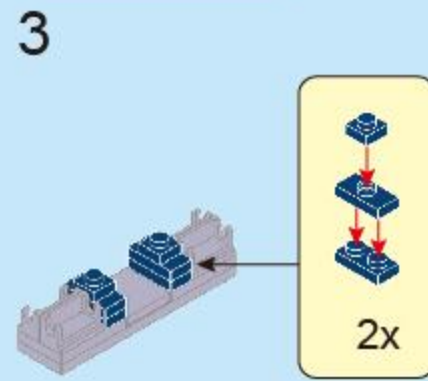
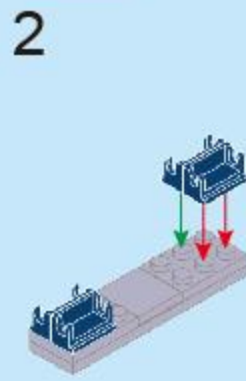
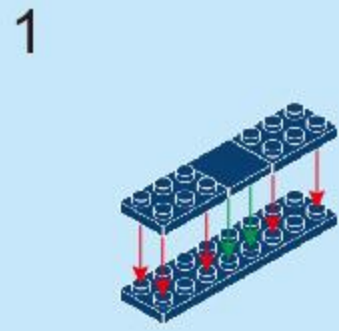
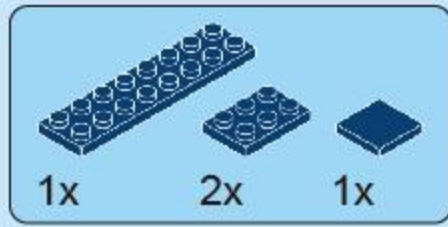

10

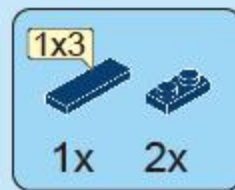
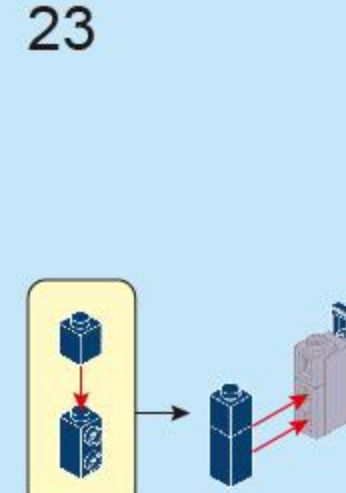
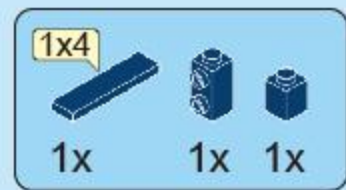
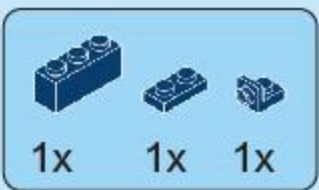
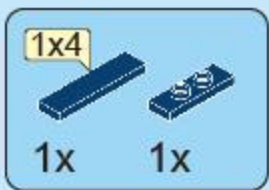
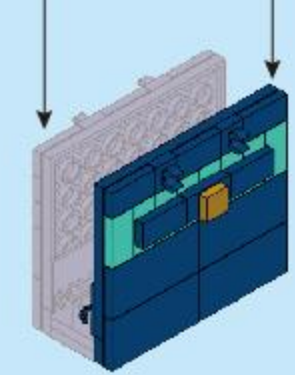
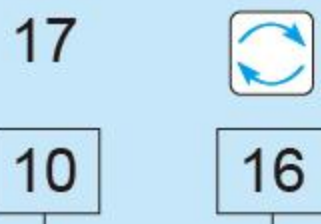
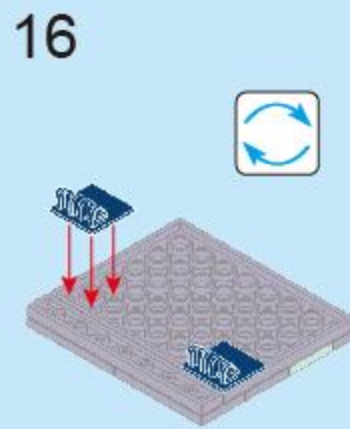
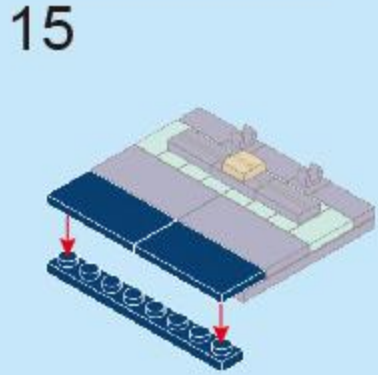
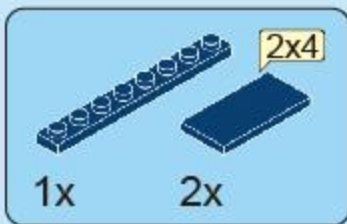
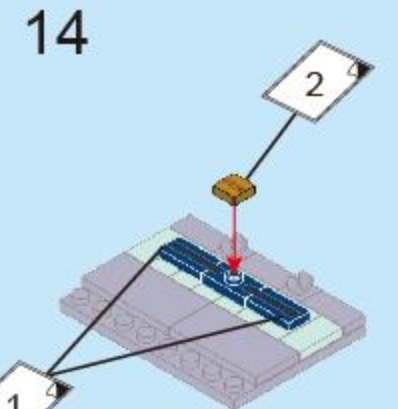
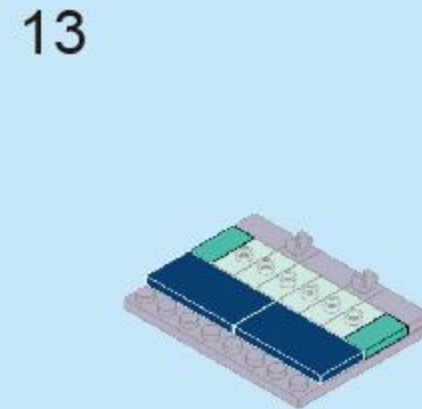
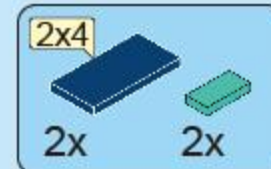
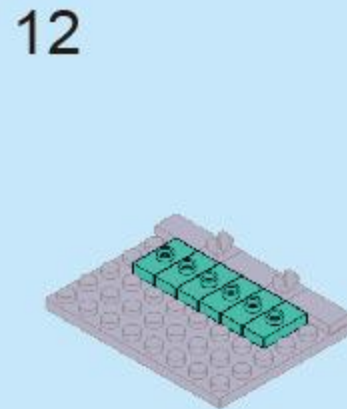
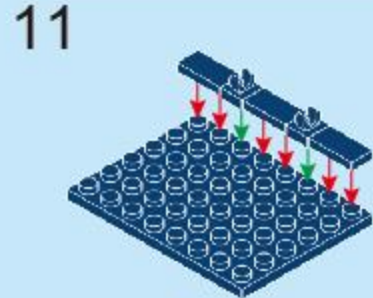
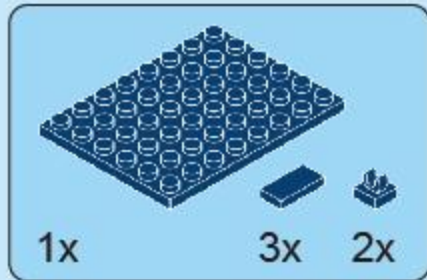
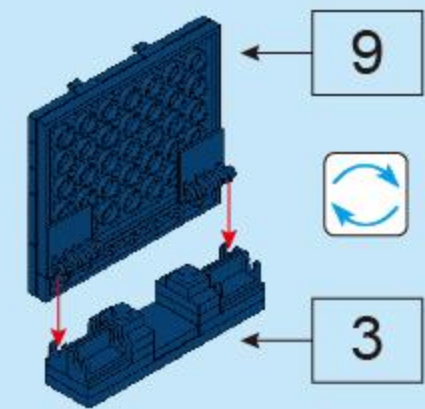

25

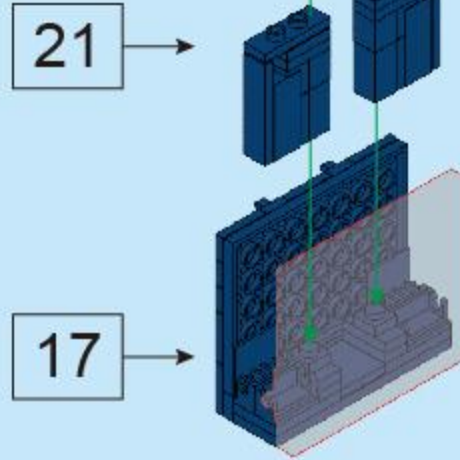

24

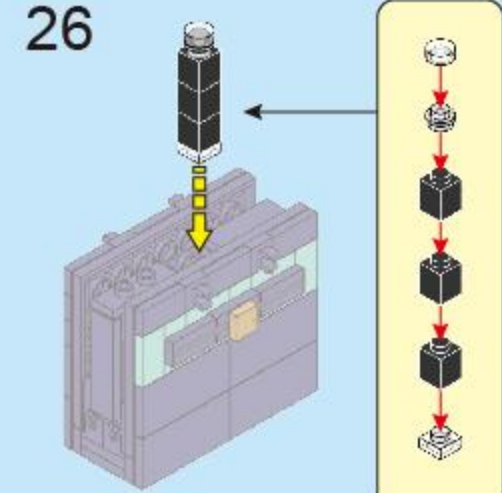



1.09.04.8296.03

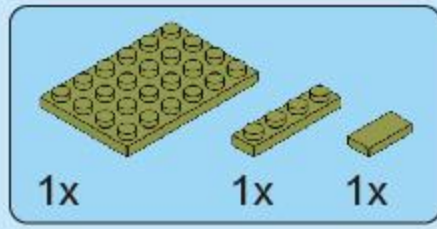

1

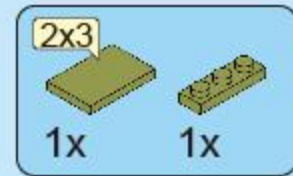

2

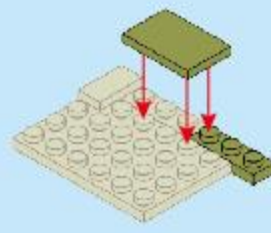

3

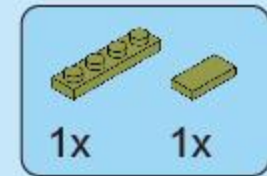
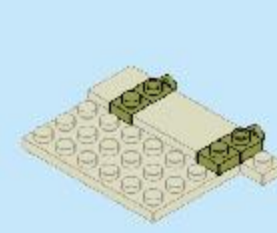

4

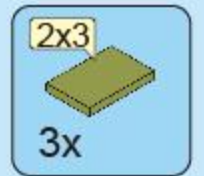
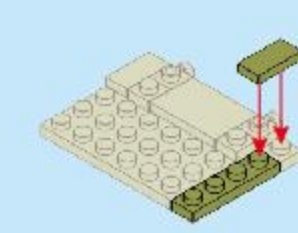

5

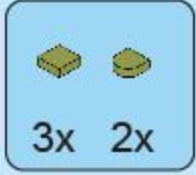
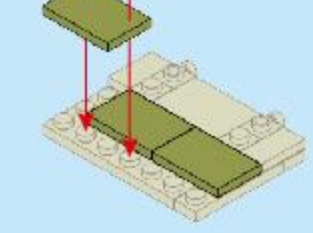

6

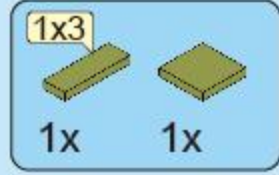
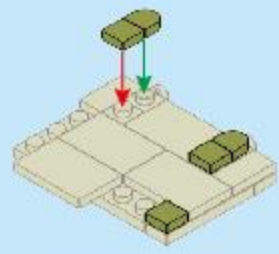

7

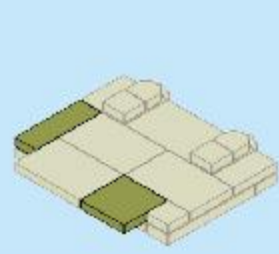

8

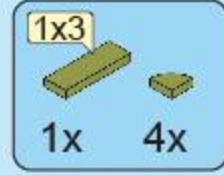
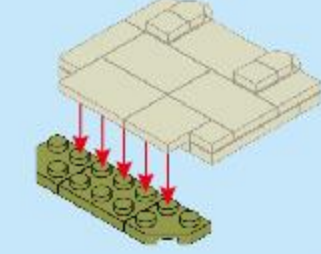

9

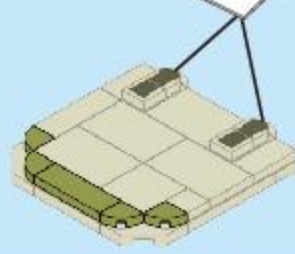

10

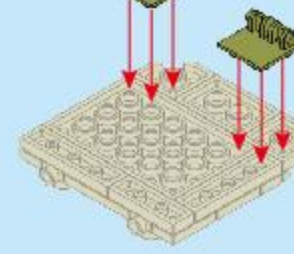

11

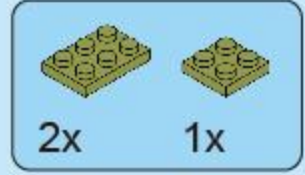
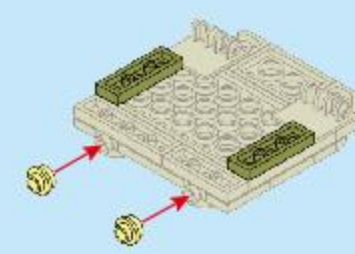

12



13

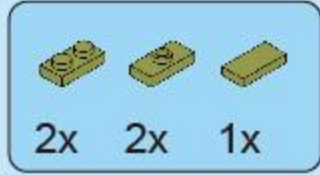
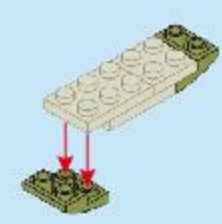

14

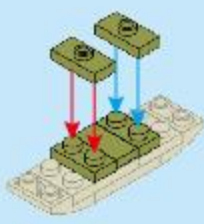

15



16

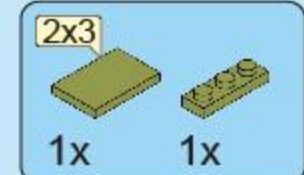
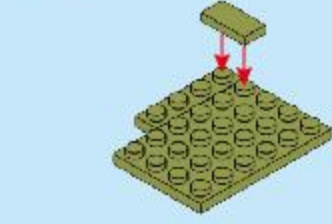

17

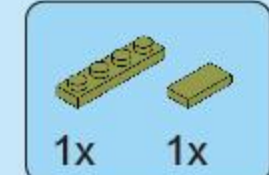
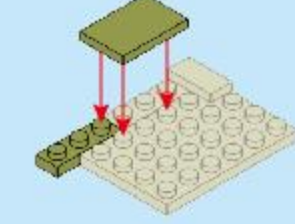

18

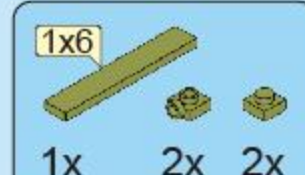
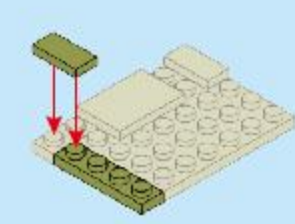

19

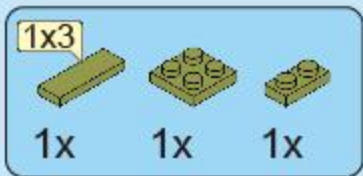
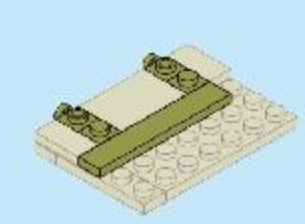

20

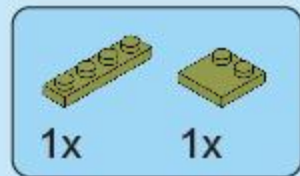
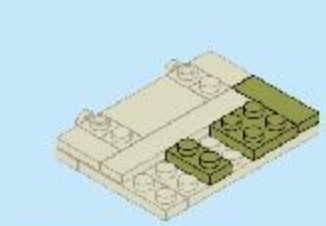

21

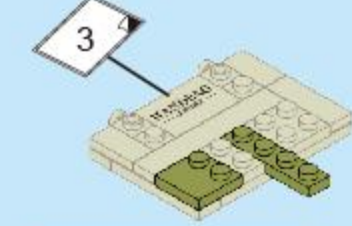

22

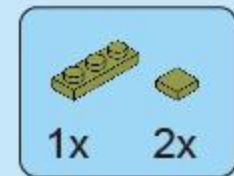
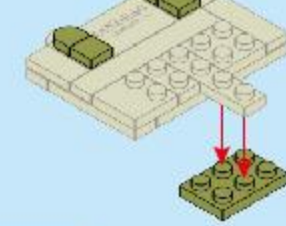

23

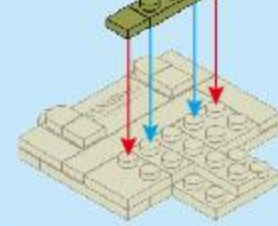

24

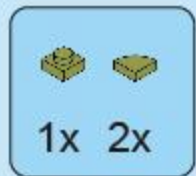
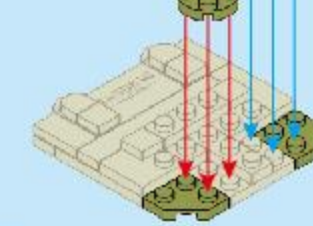

25

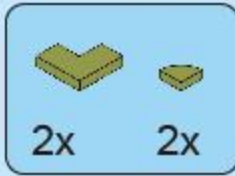
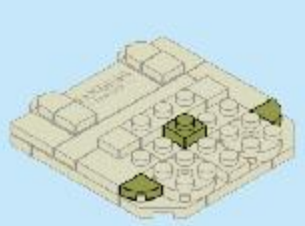

26

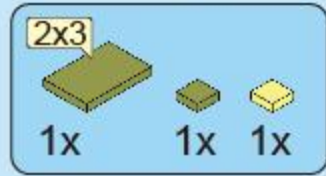
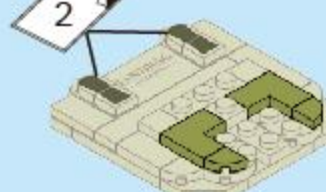

27

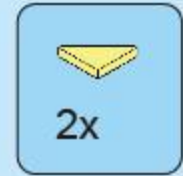
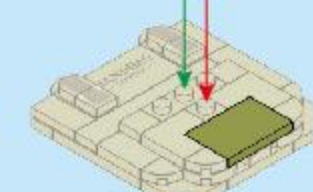

28

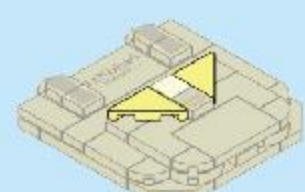

29

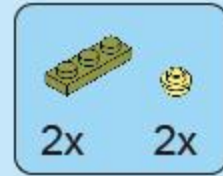
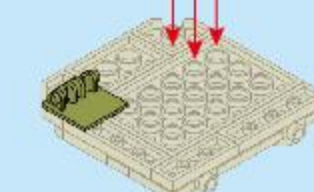

30



31

11

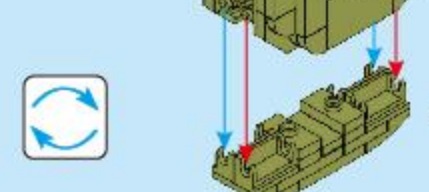

30

15

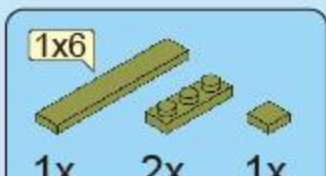

32



33

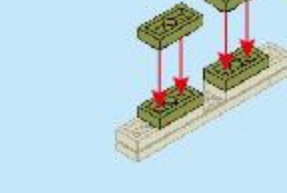

34

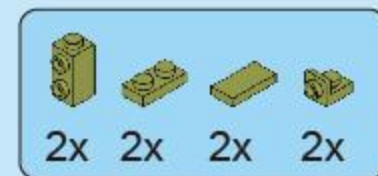
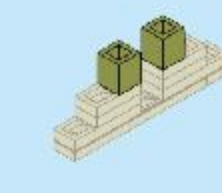

35

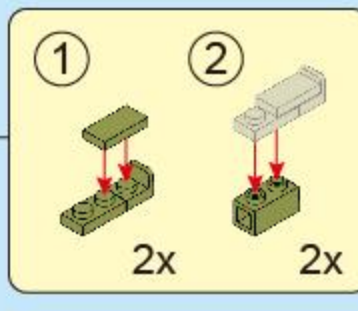

1

2

2x

2x

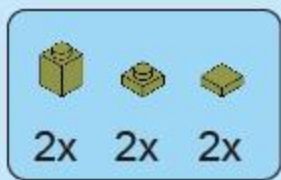

36

37

38

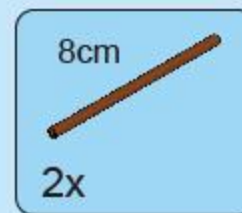

39

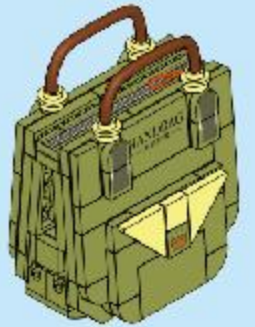
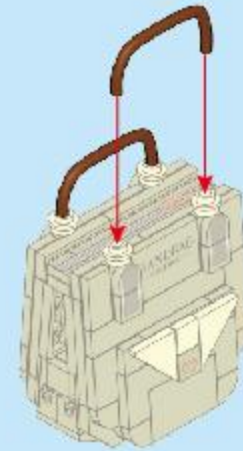
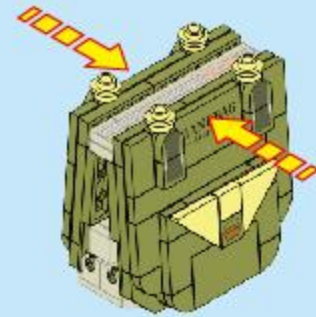
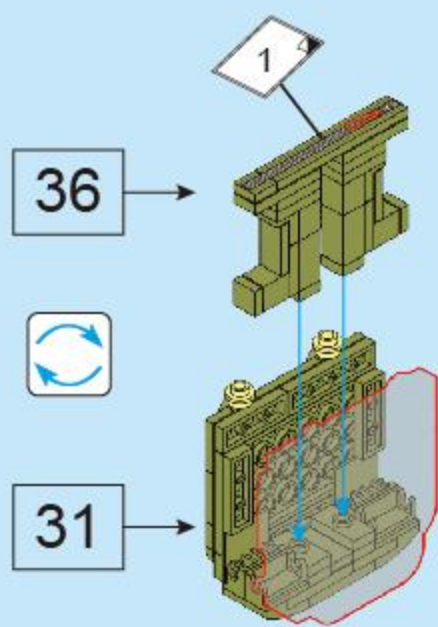
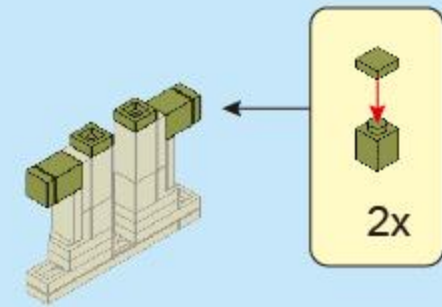

A

1



2



3



4



5



B

1



2



3



4



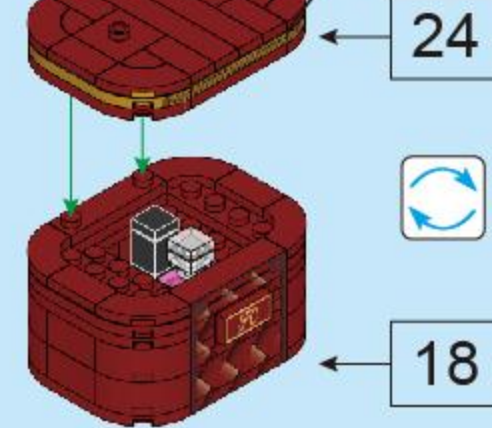
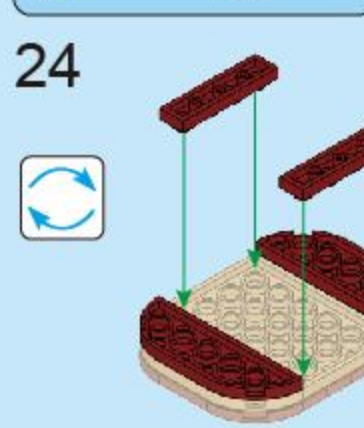
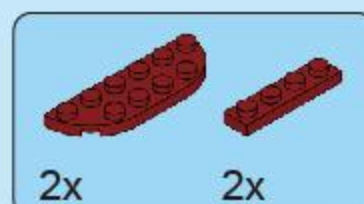
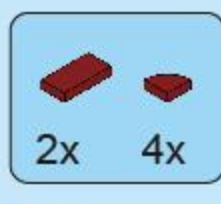
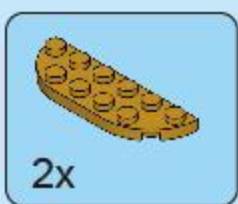
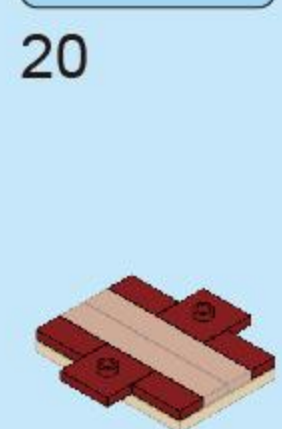
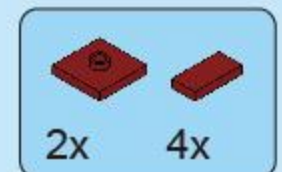
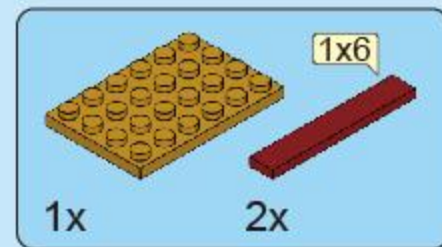
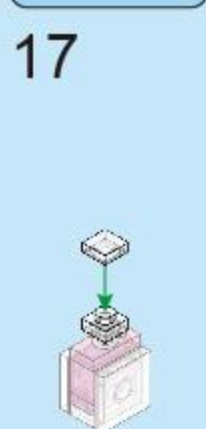
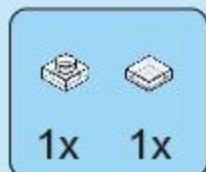
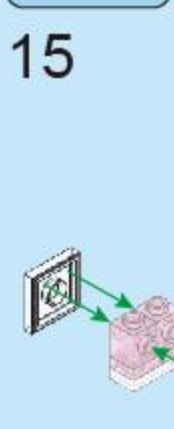
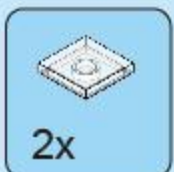
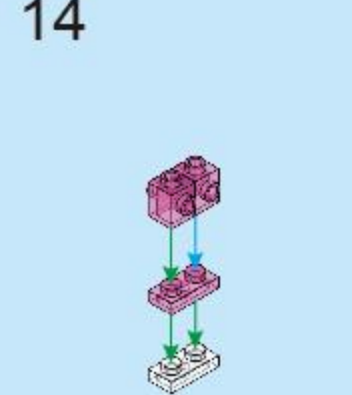
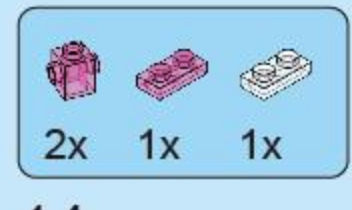
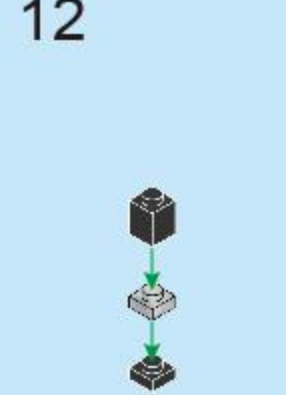
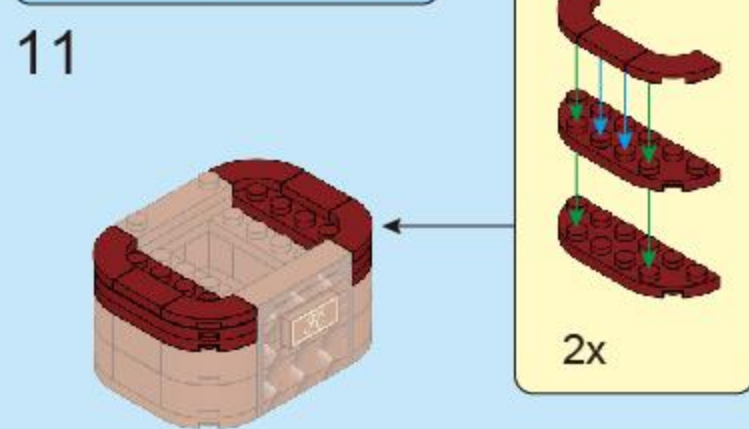
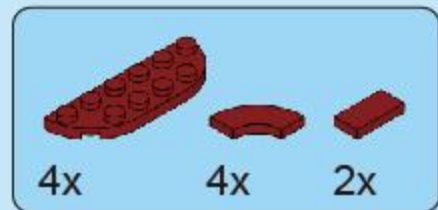
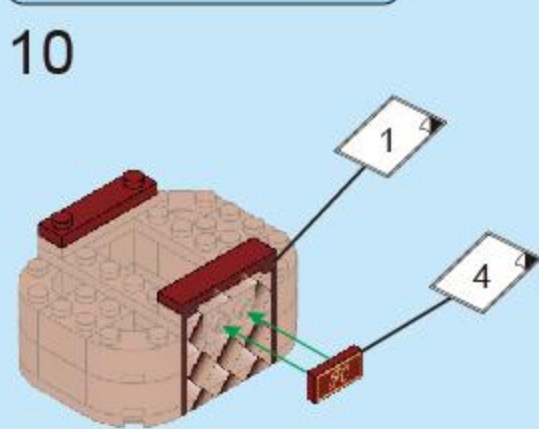
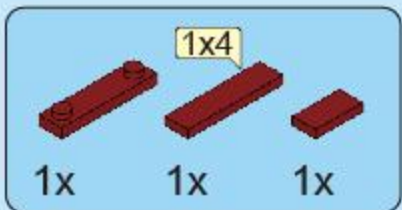
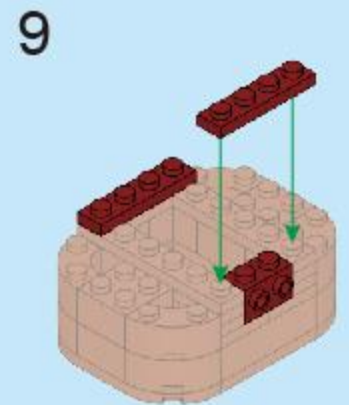
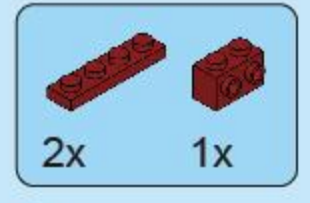
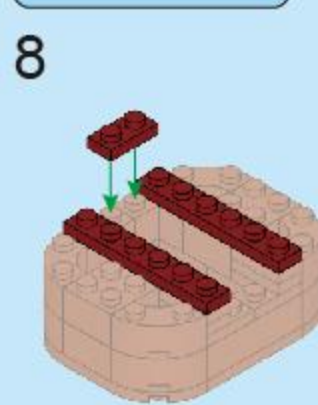
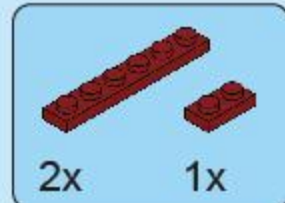
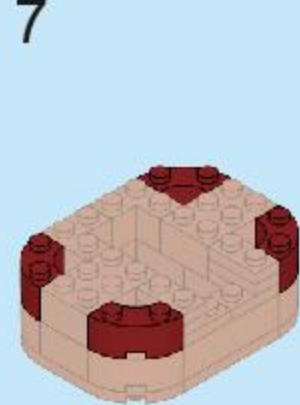
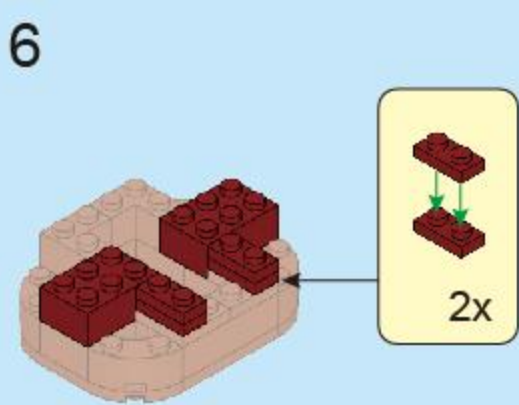
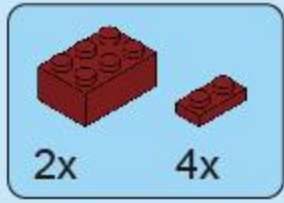
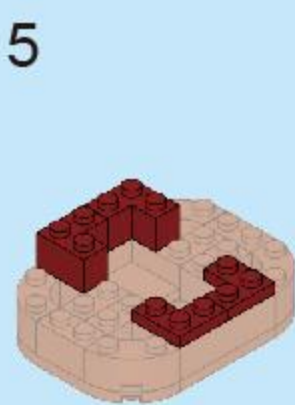
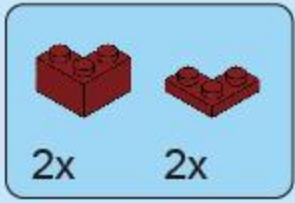
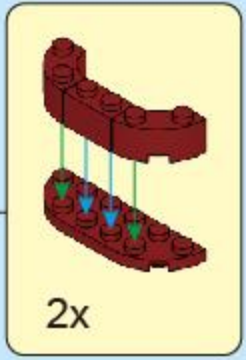
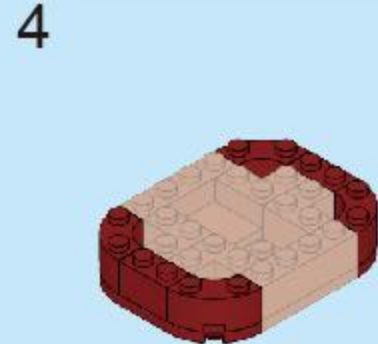
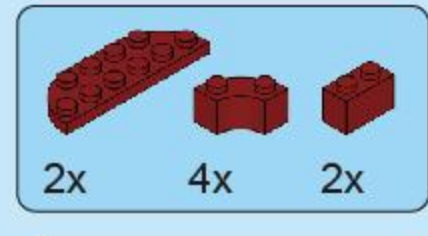
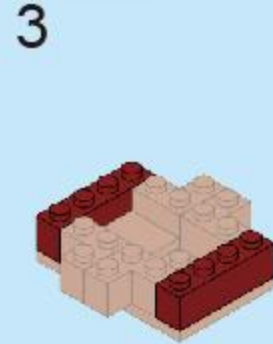
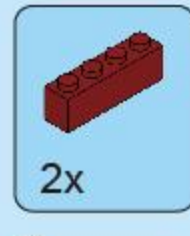
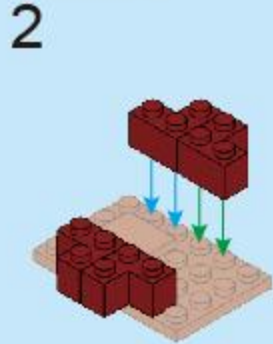
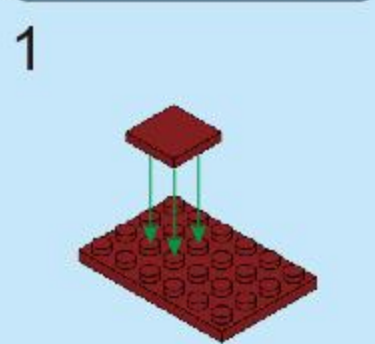
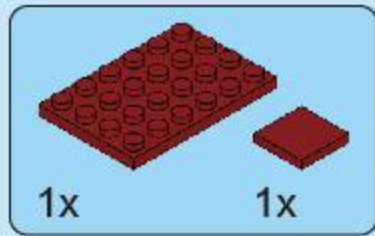

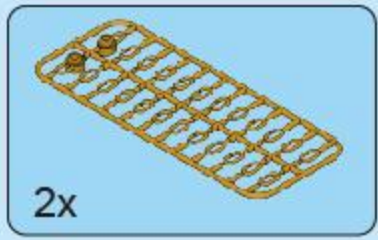

26

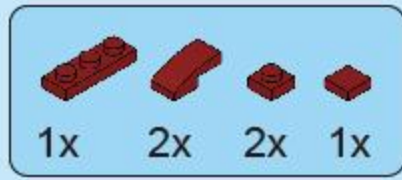
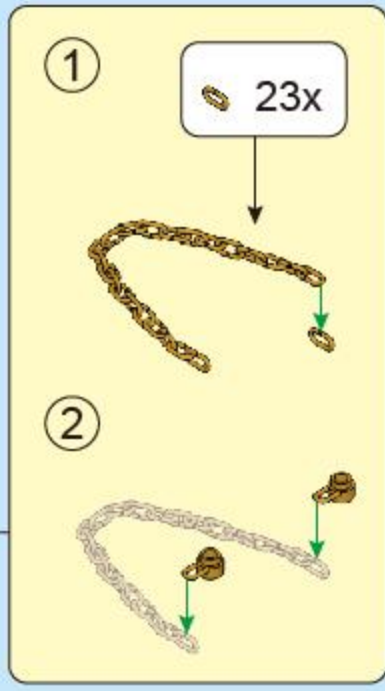

27

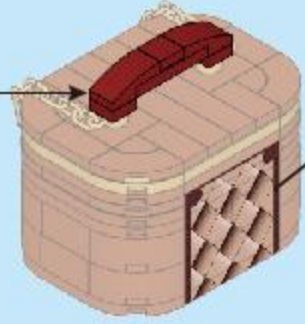
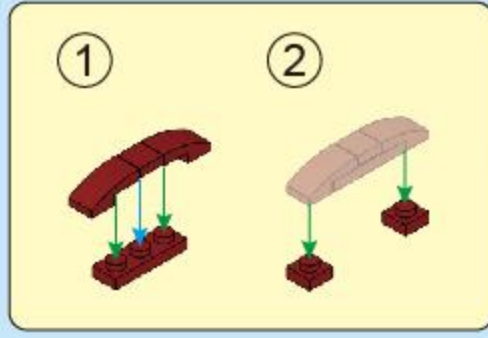

1

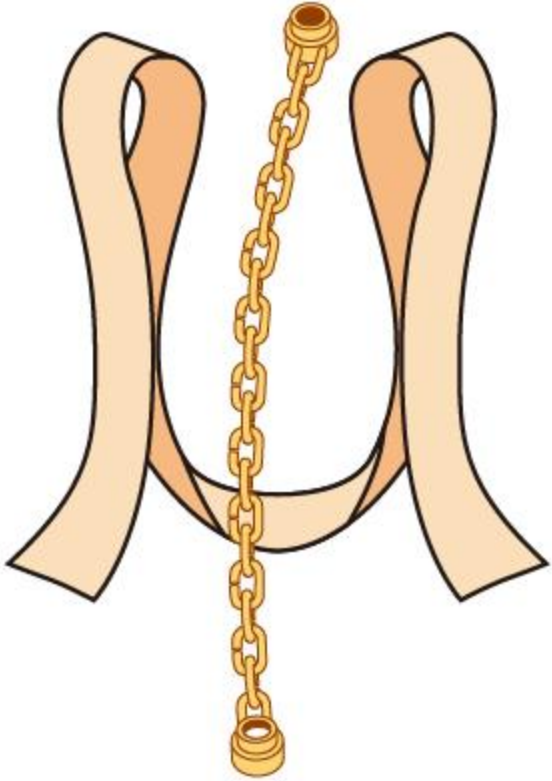

2

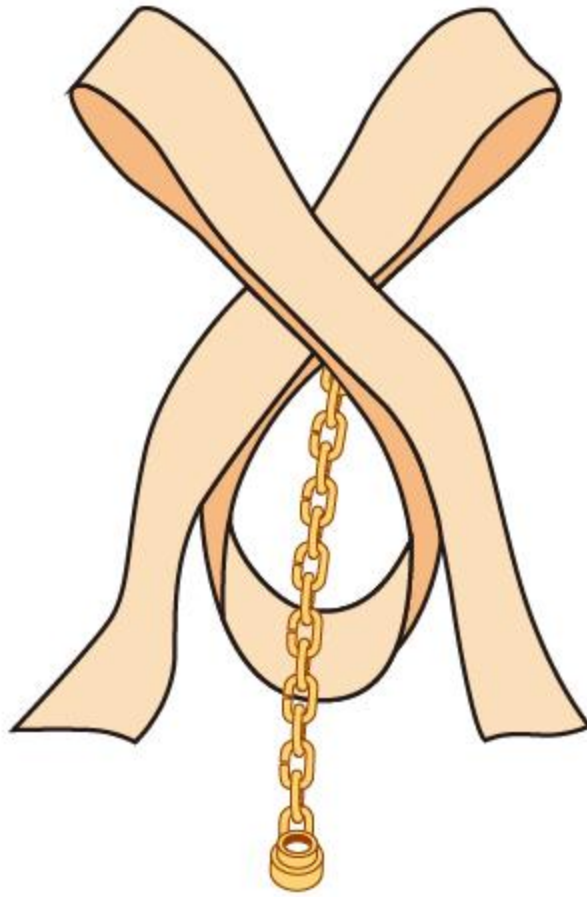

3



4

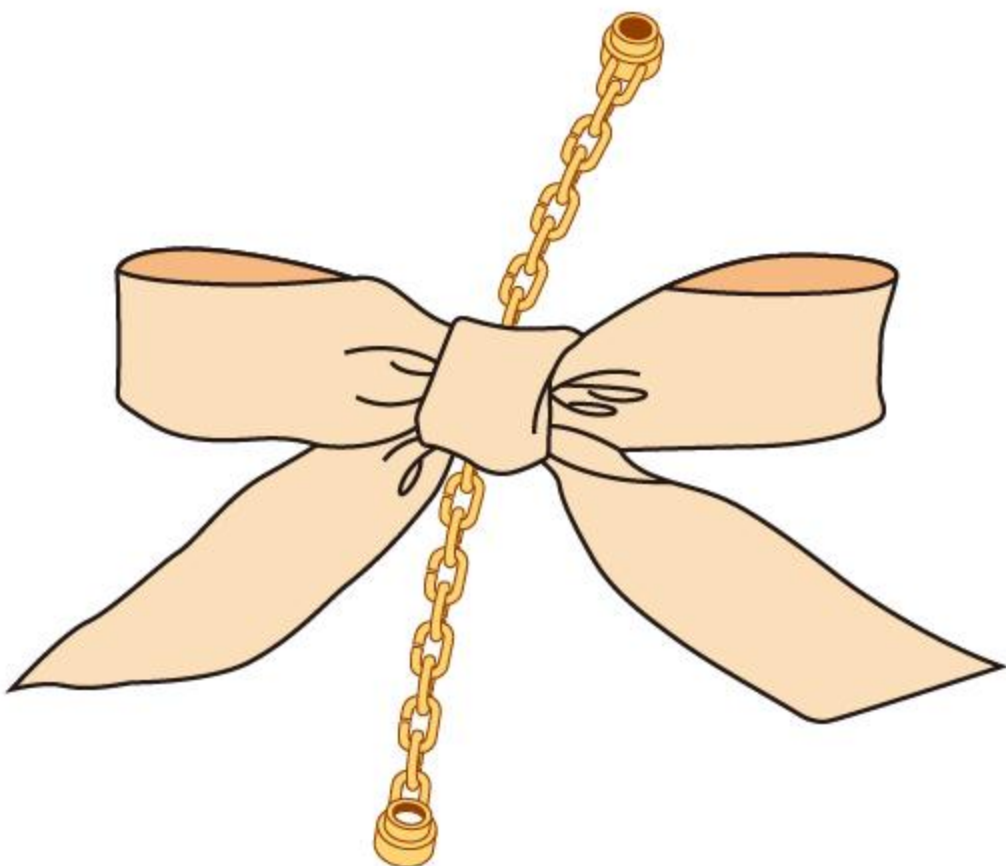

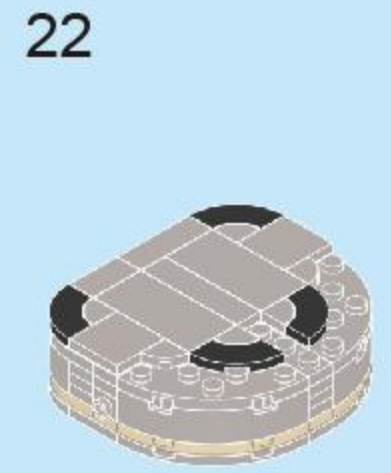
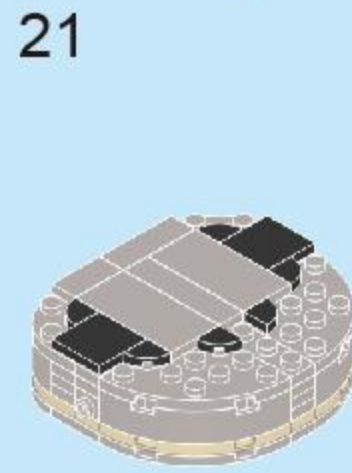
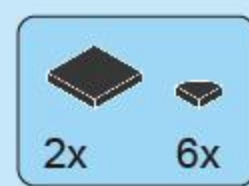
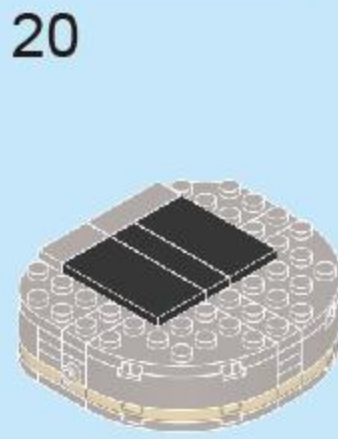
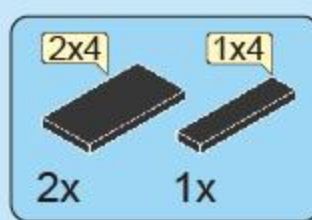
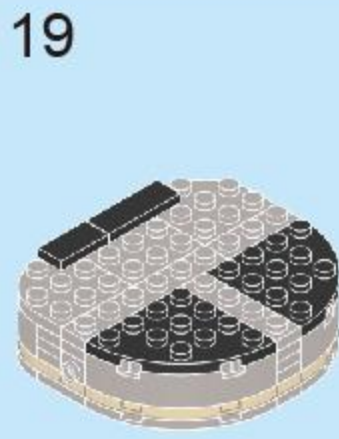
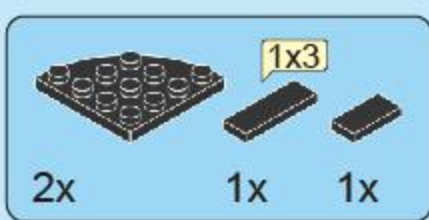
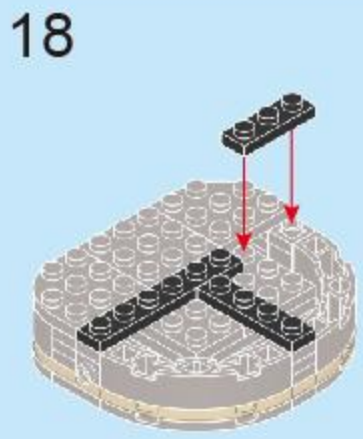
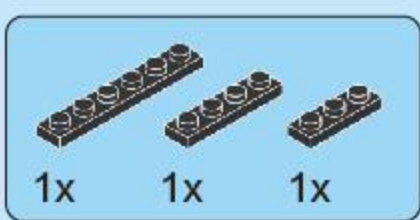
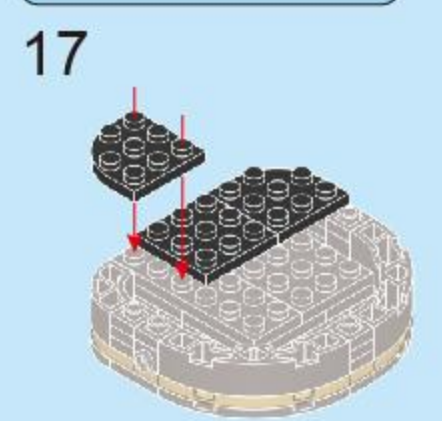
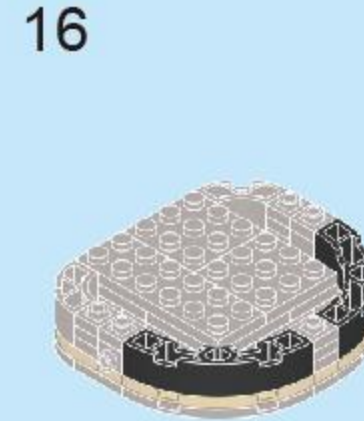
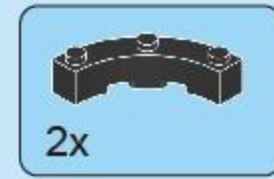
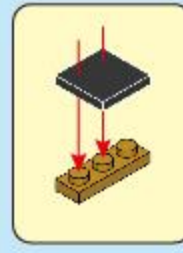
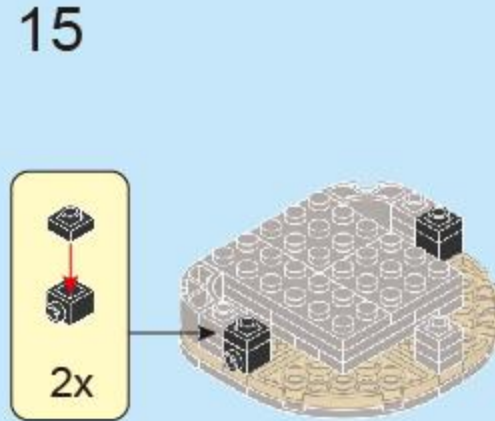
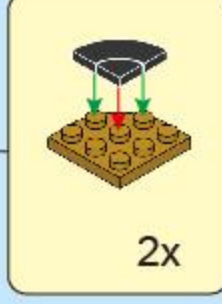
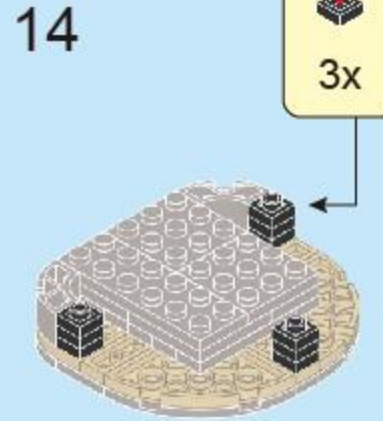
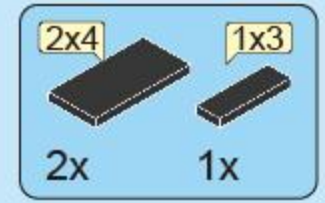
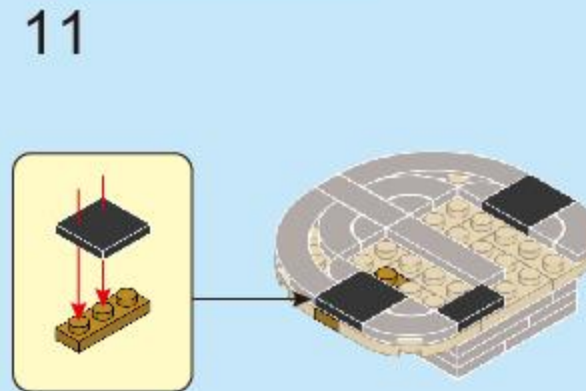
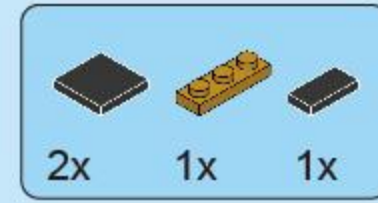
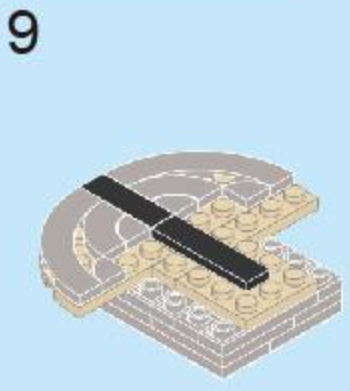
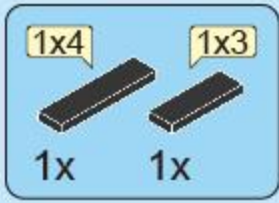
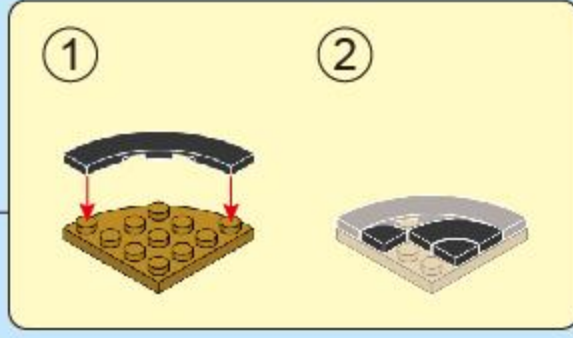
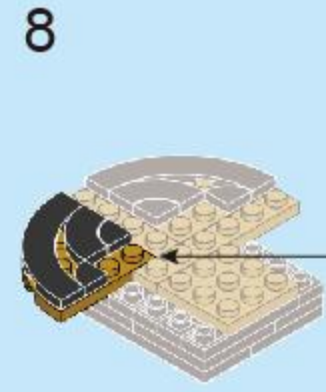
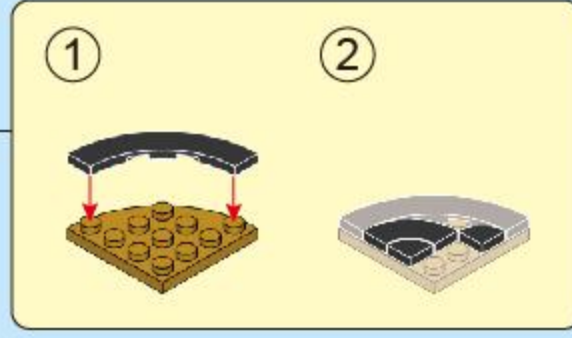
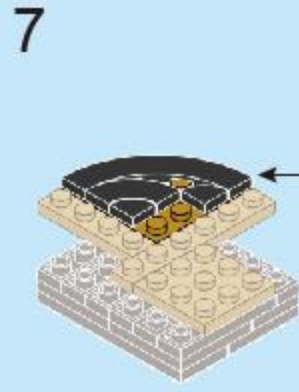
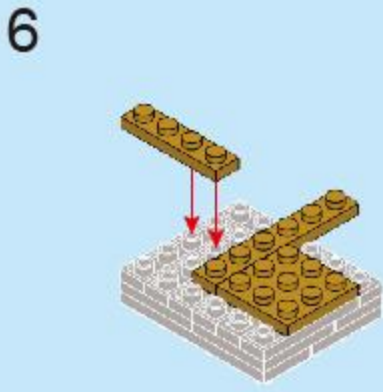
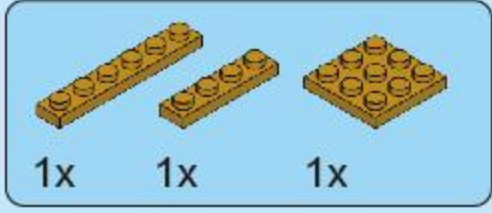
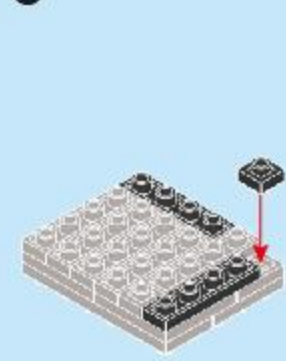
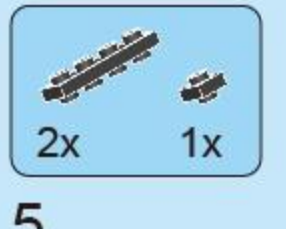
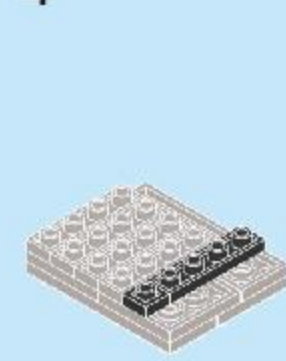
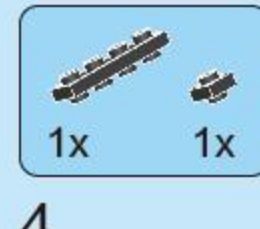
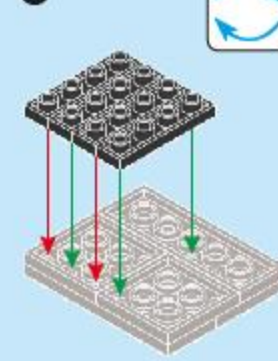
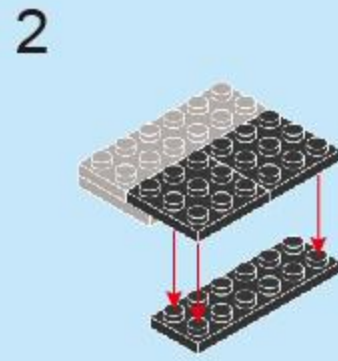
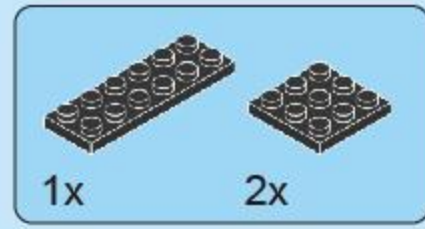
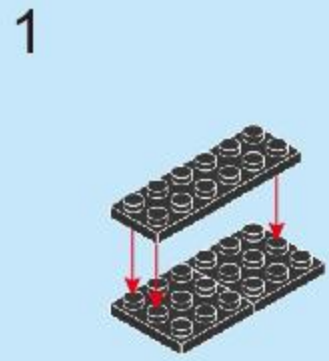
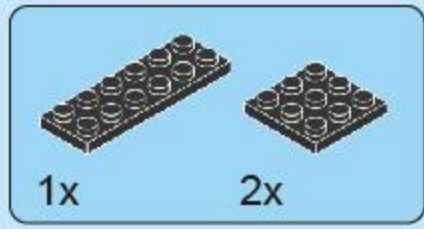

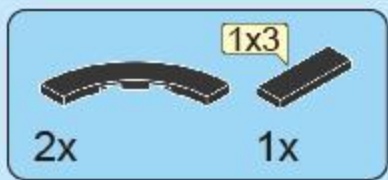

23

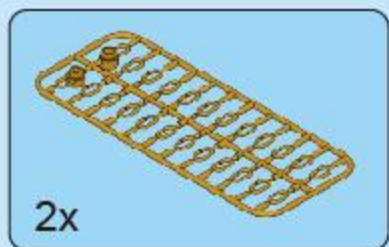
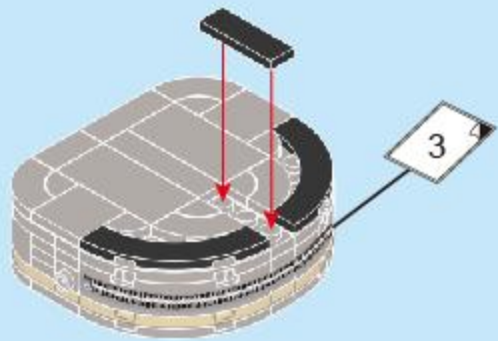

2x

24

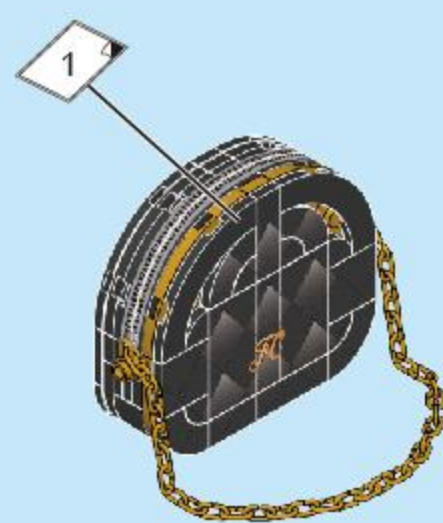
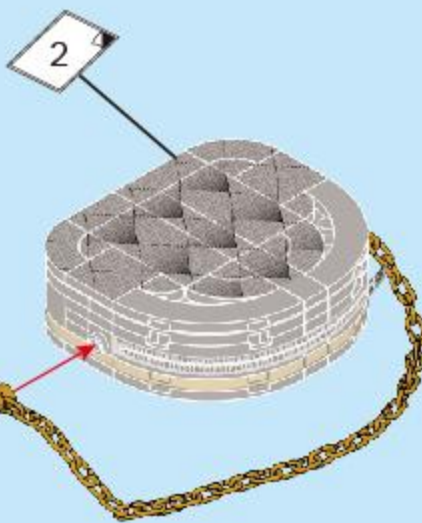

1

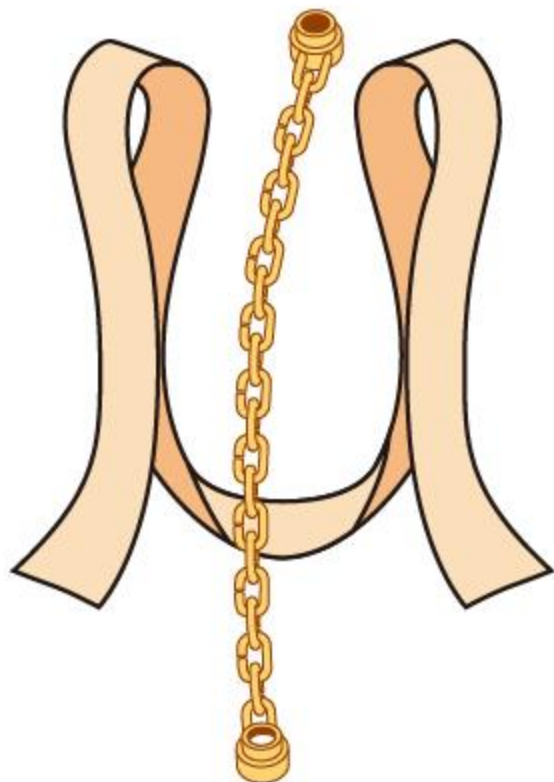

2

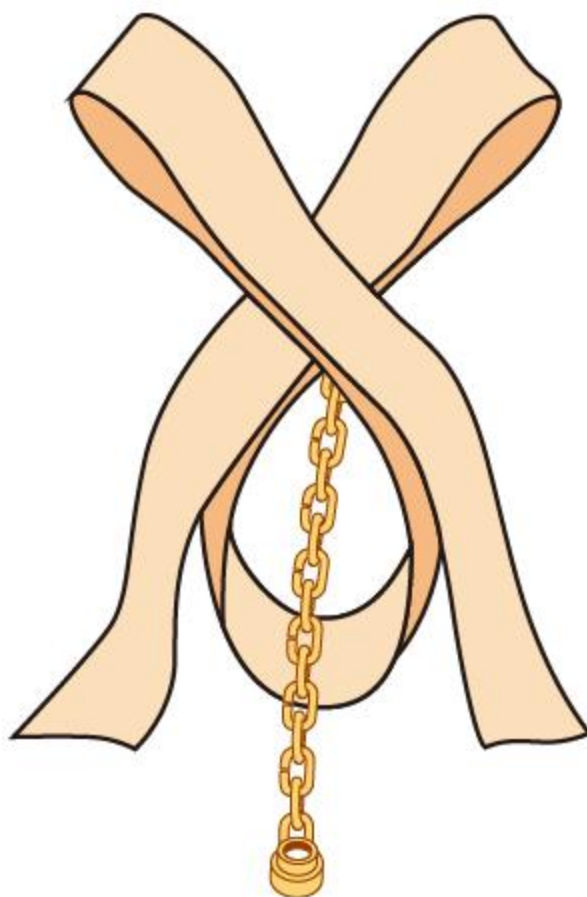

3



4

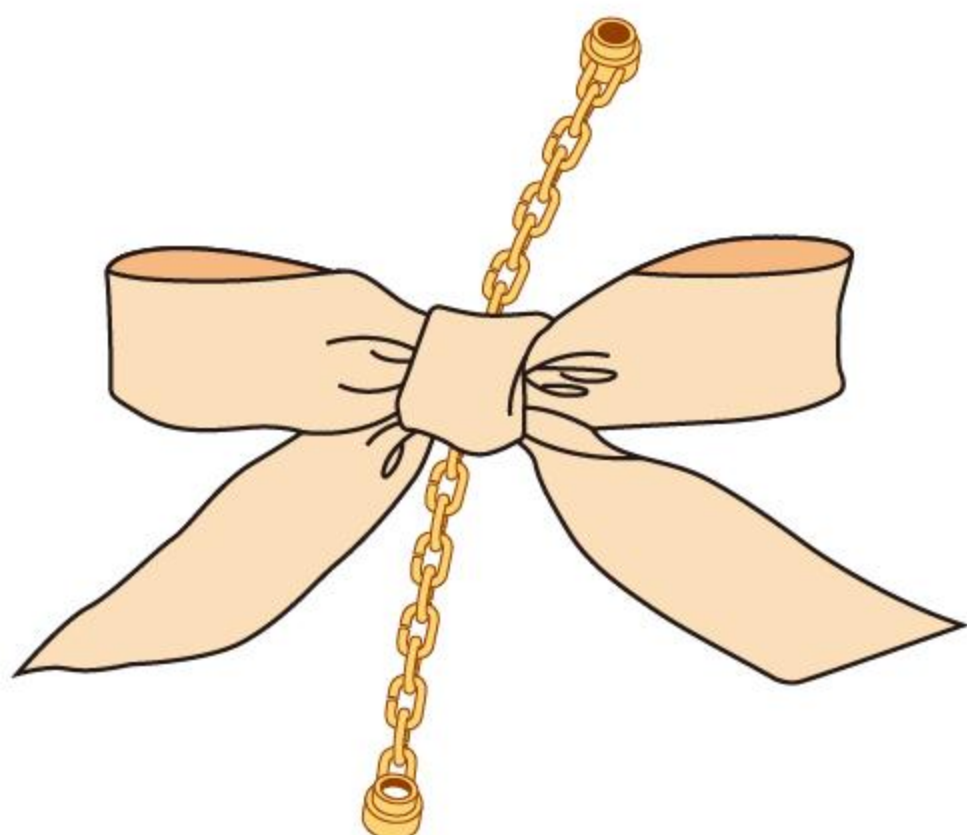

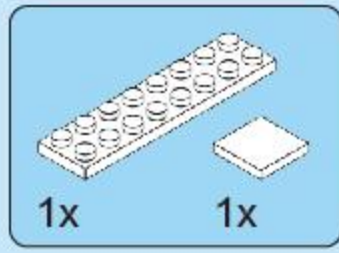

1

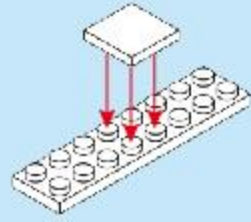

2

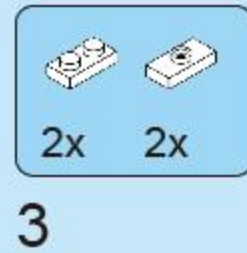
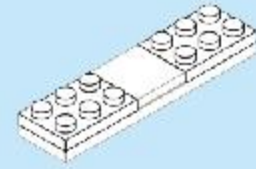

3

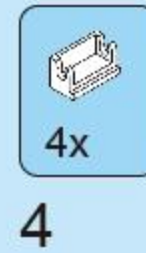
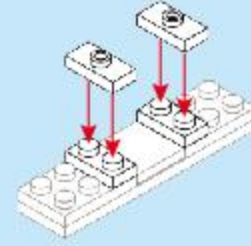

4

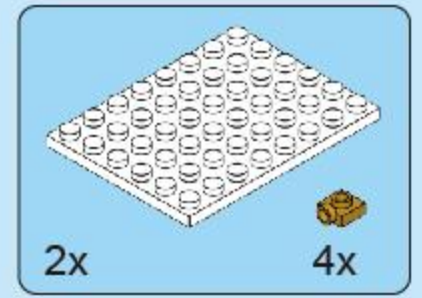
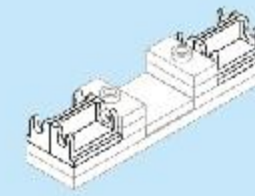

5

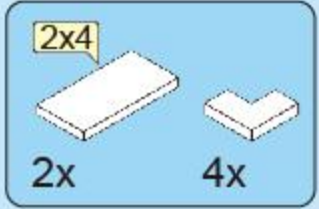
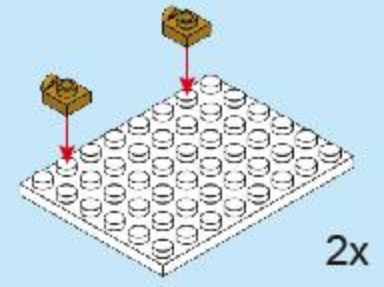

6

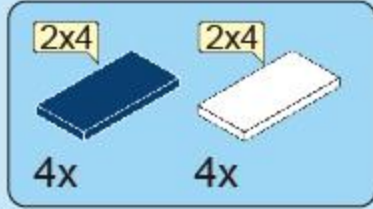
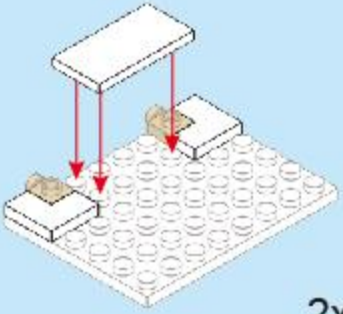

7

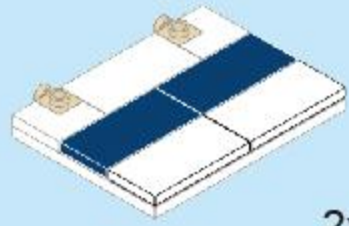

8

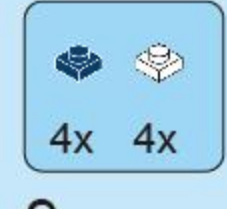
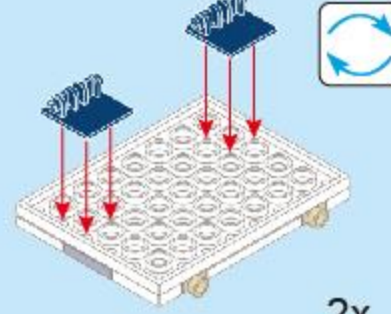

9

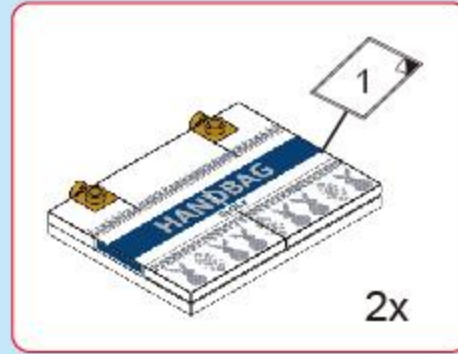
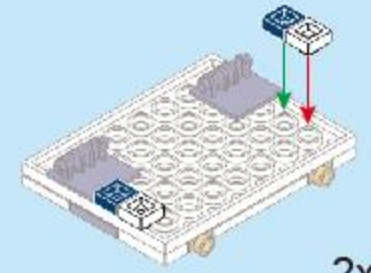

2x

10

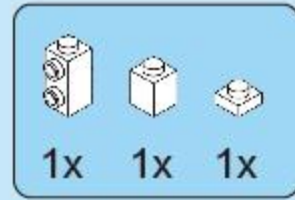
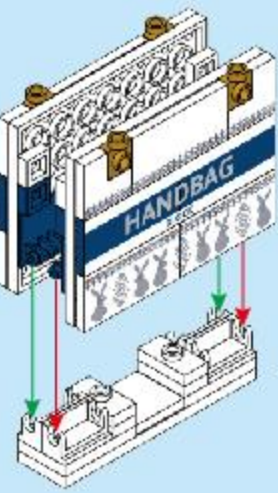

11

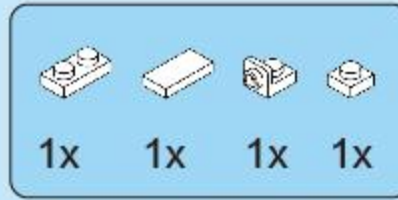

12

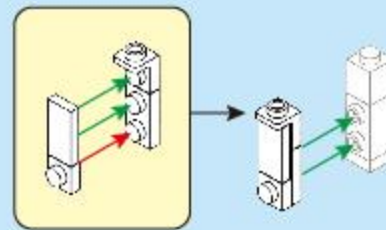

13

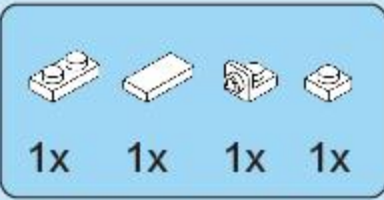
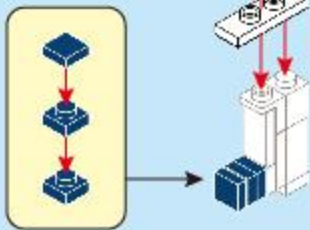

14

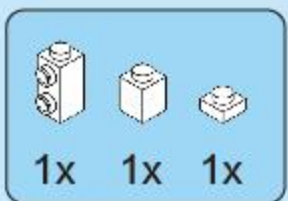
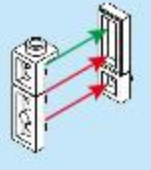

15

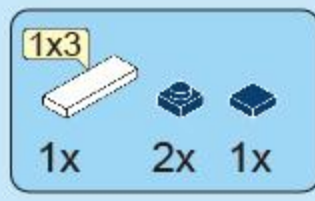
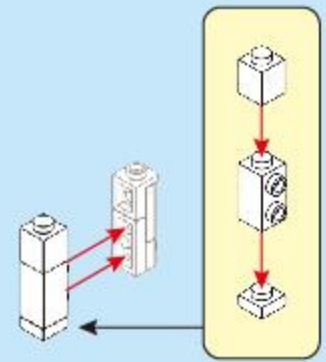

16

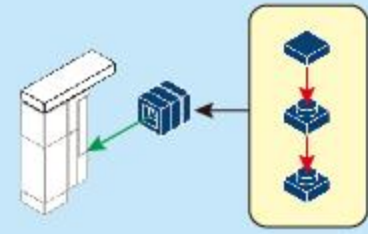

17

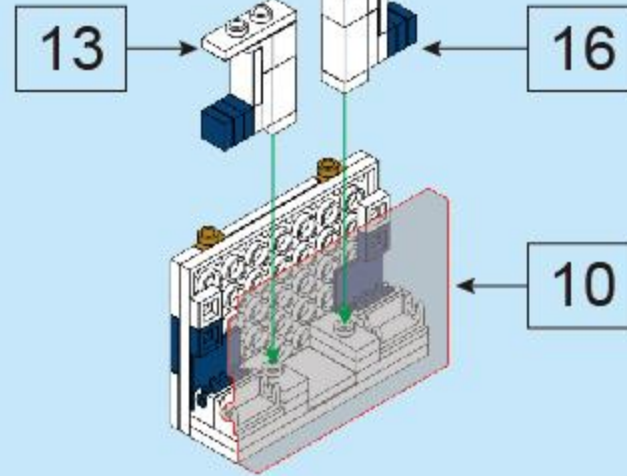

18



19

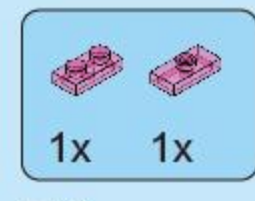
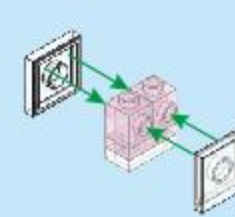

20

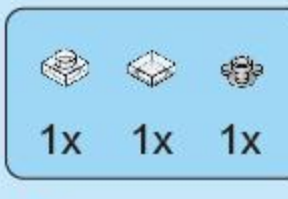
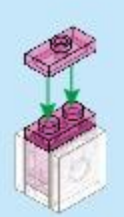

21

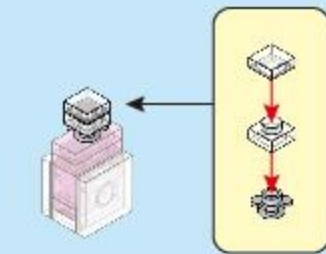

22



21

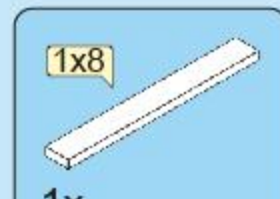

23

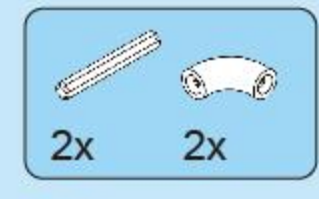
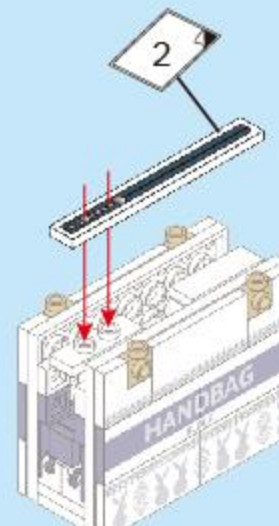

24



2x

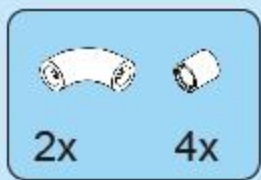

25



26

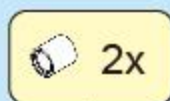

2x



2x

27

28

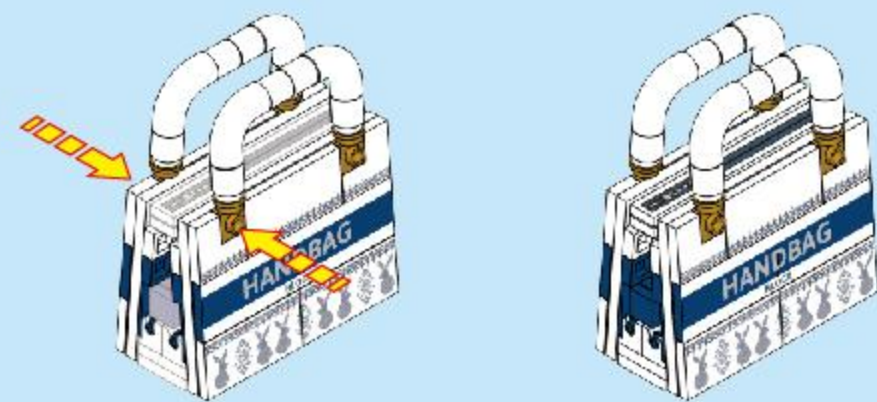
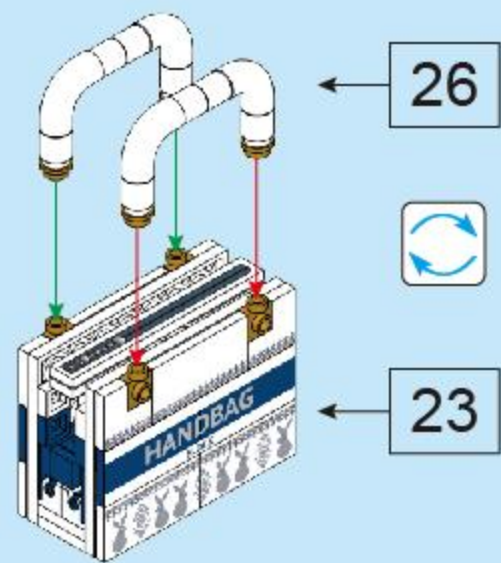

A

1

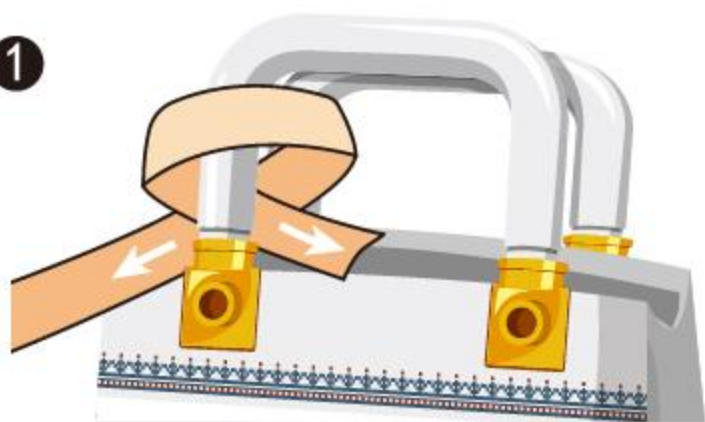

2

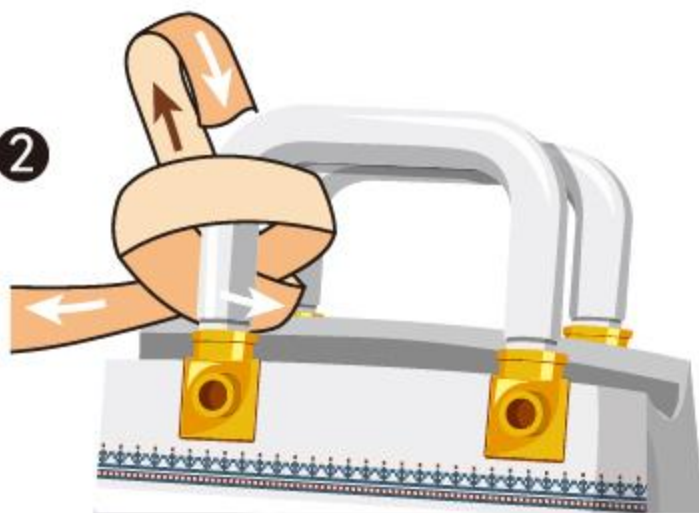

3

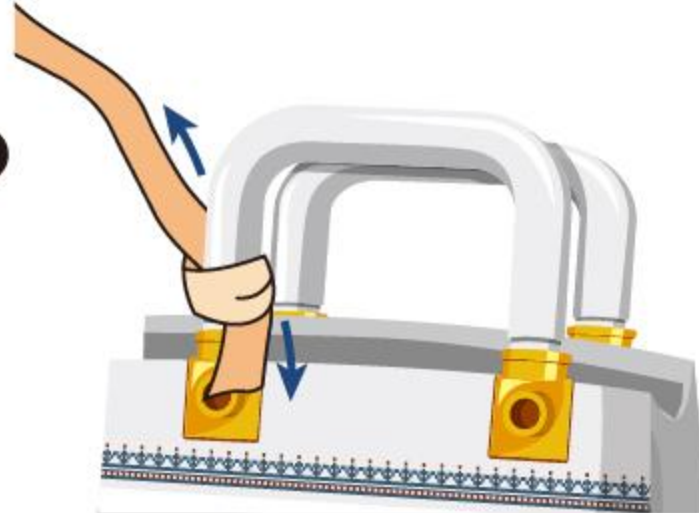

4

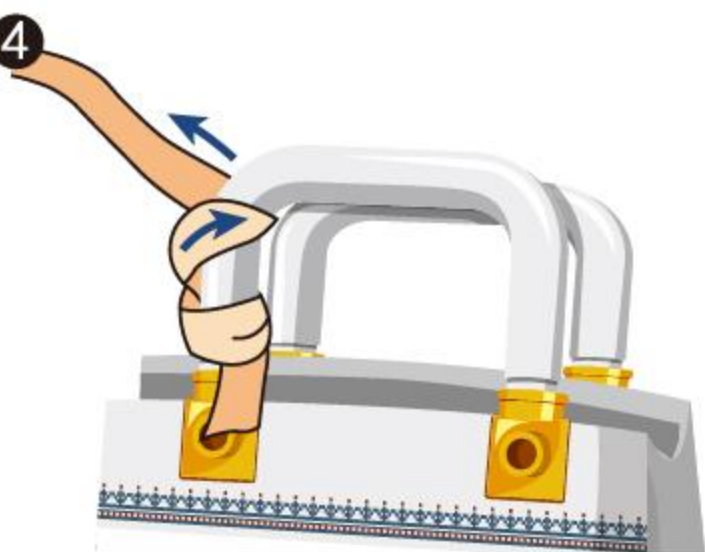

5

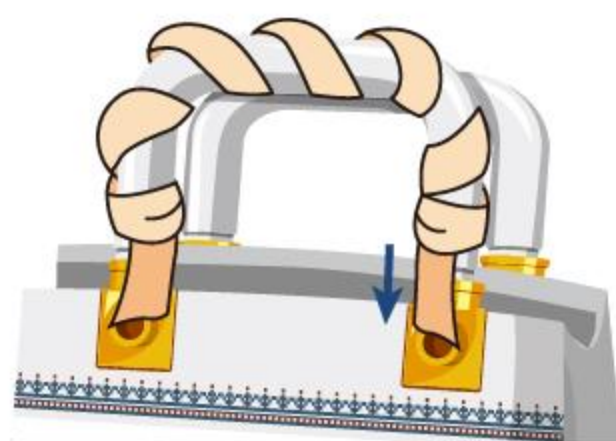

B

1

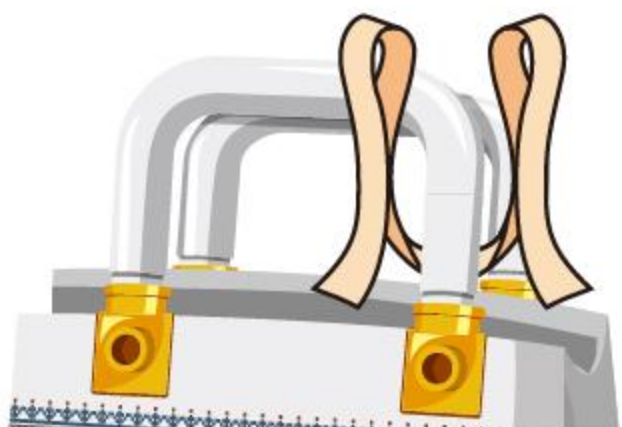

2

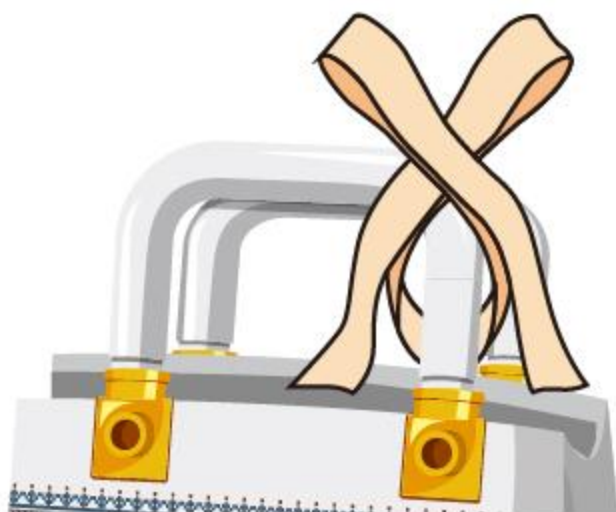

3



4

