

FC1024



COLLECT 5 MODELS
TO COMBINE ZEUS MARS

拆件器使用方法，仅为示例

Usage of Brick Separator, Just for the sample

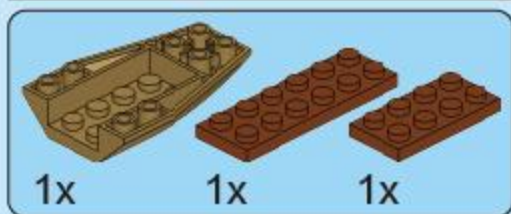
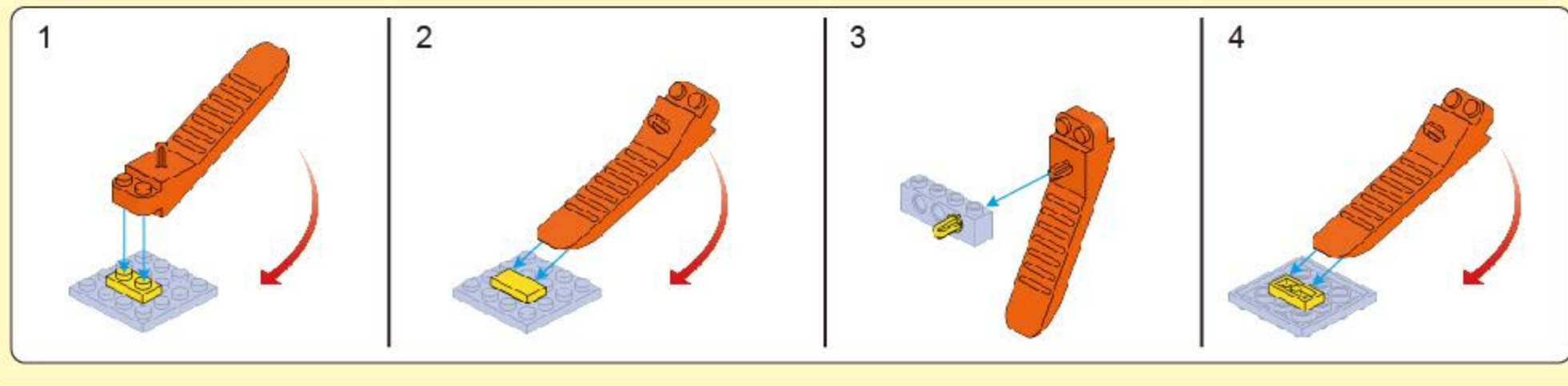

A1

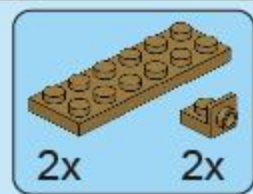
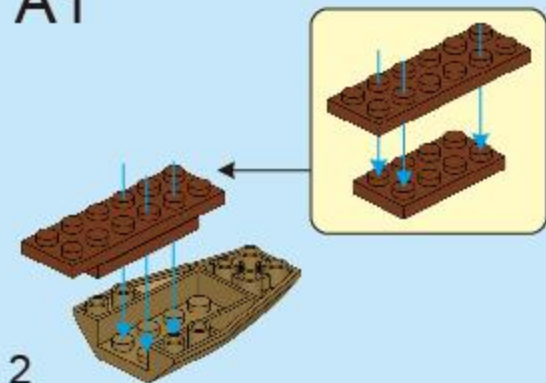

A2

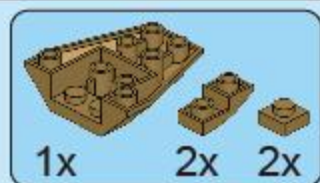
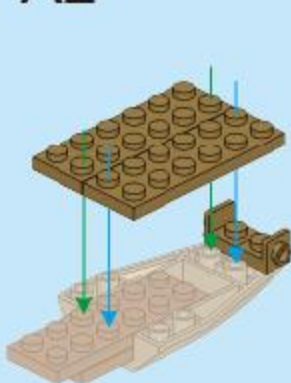

A3

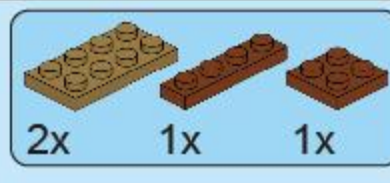
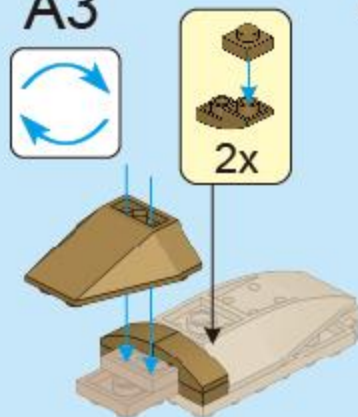

A4

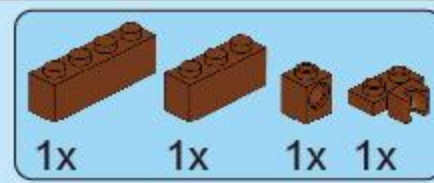
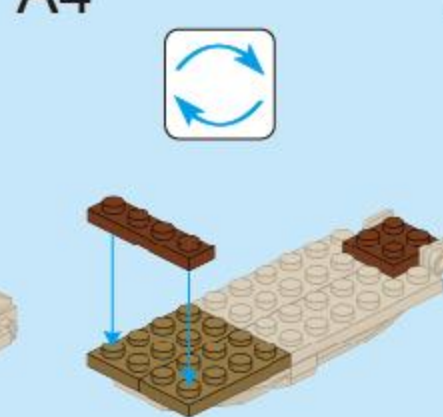

A5

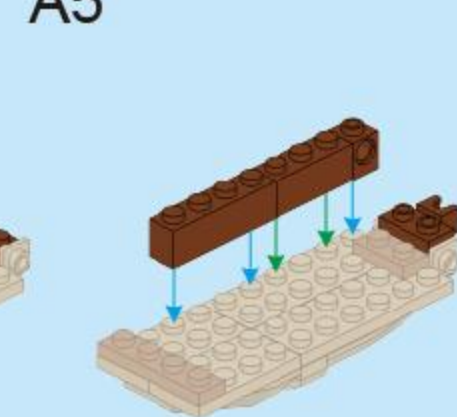

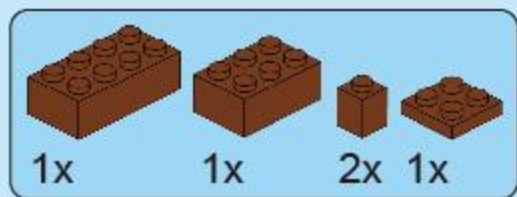

A6

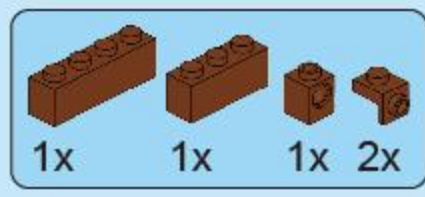
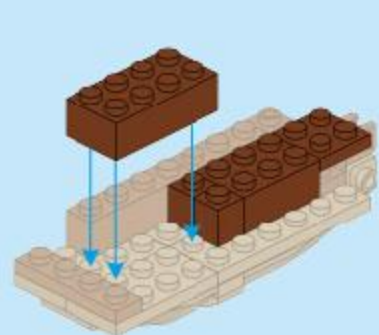

A7

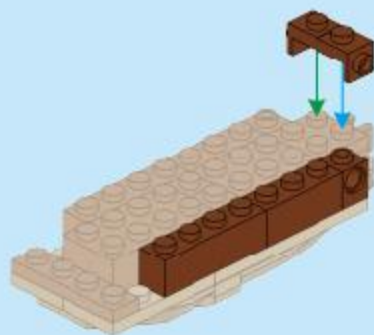

A8

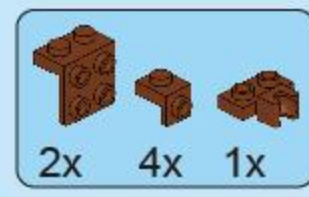
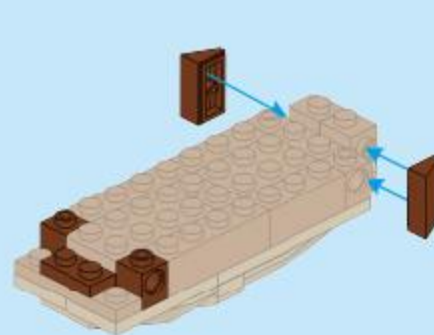

A9

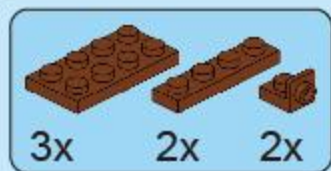

A10

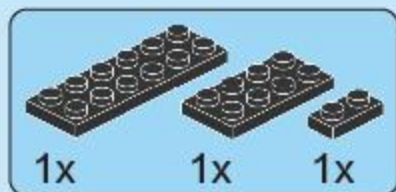
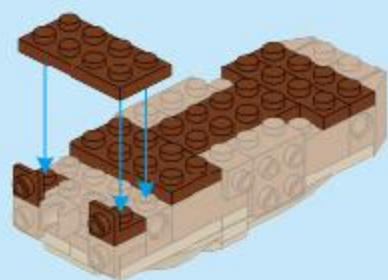

A11

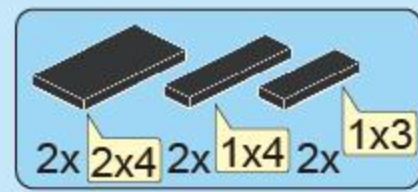
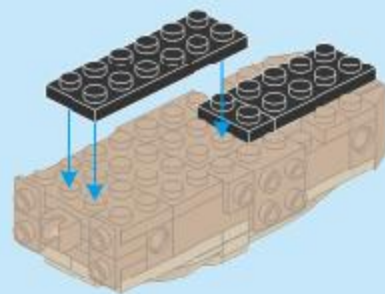

A12

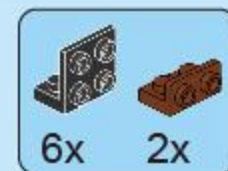
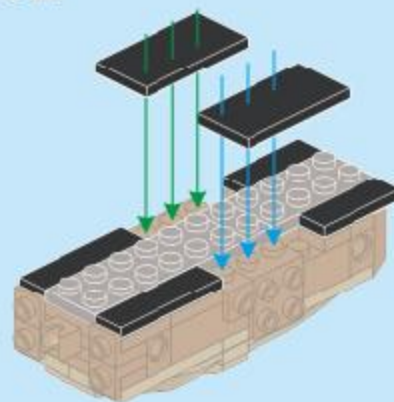

A13

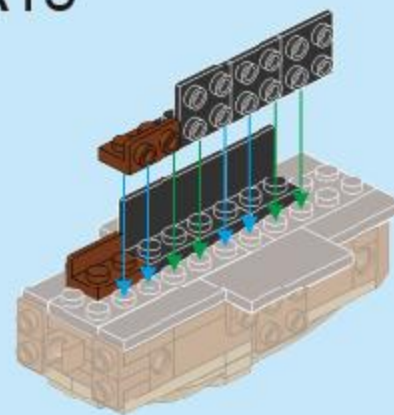

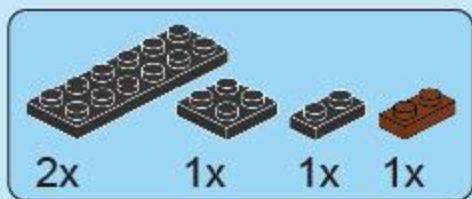

A14

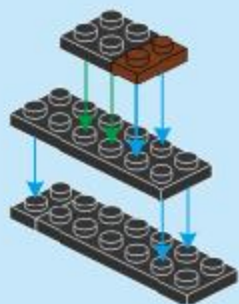

A15

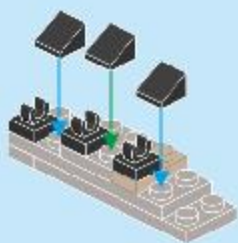

A16

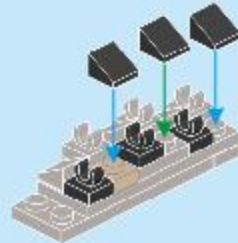

A17

A16



A13

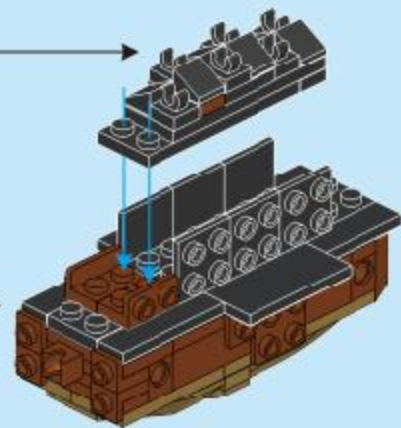

A18

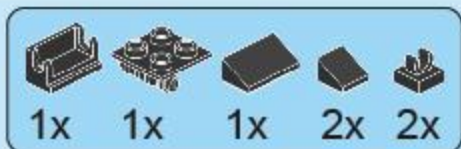
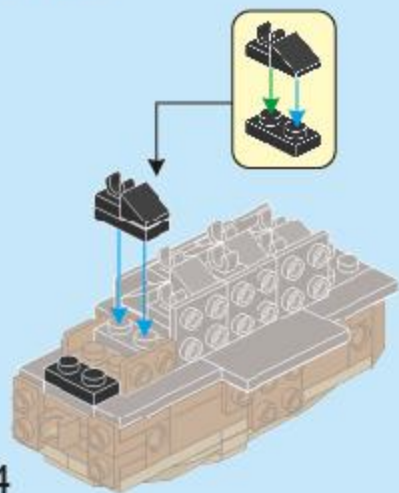

A19

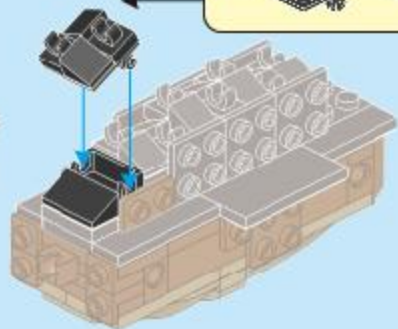
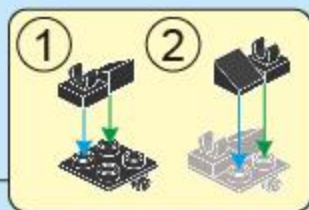

A20

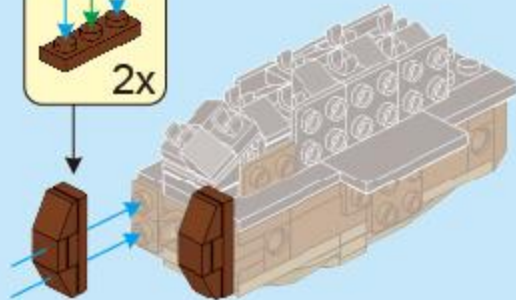
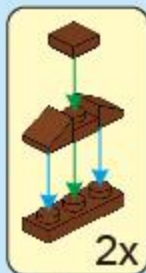

A21

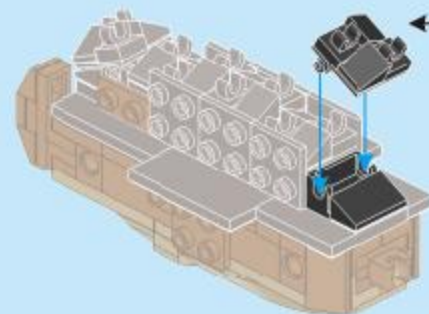
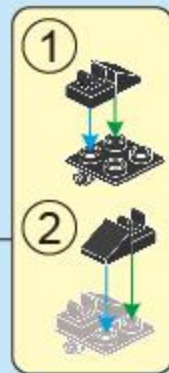

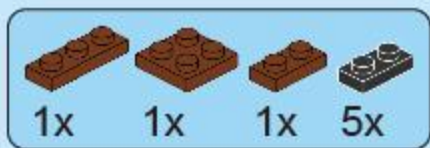

A22



A23



A24

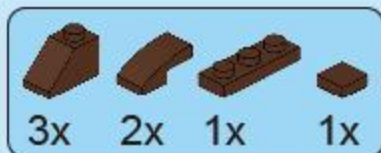
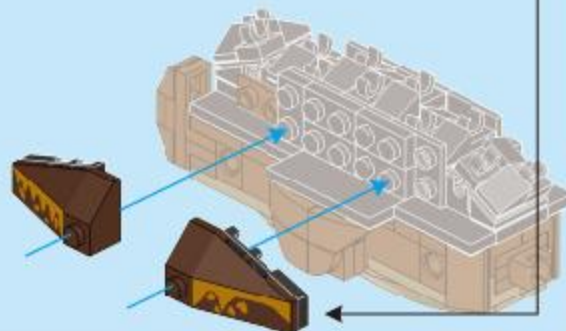
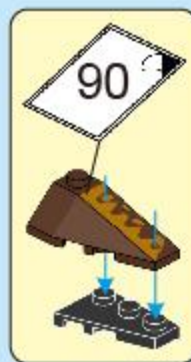
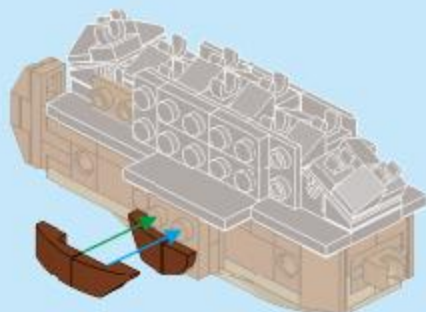
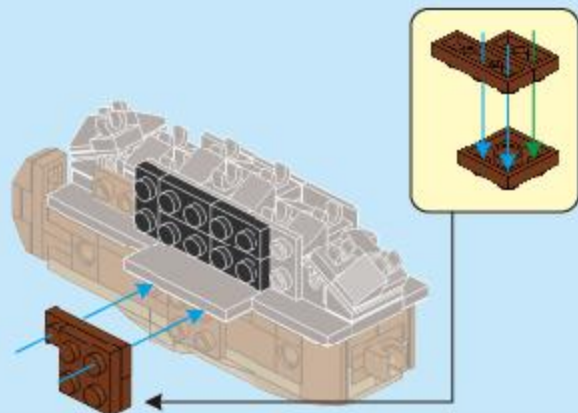
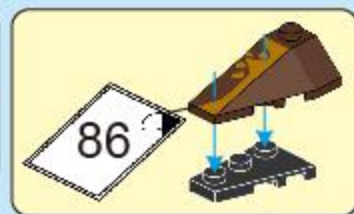

A25

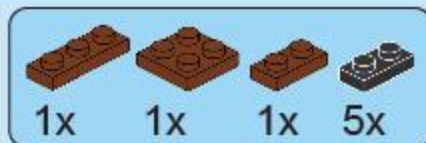
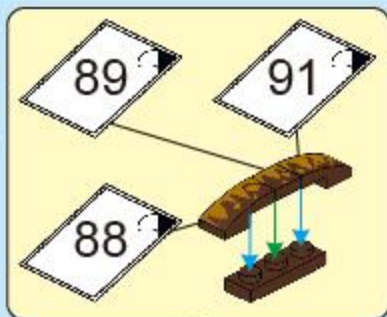

A26

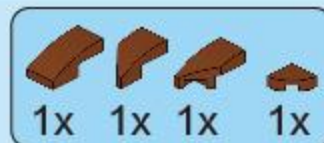

A27

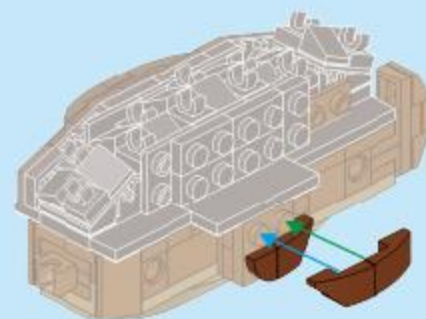
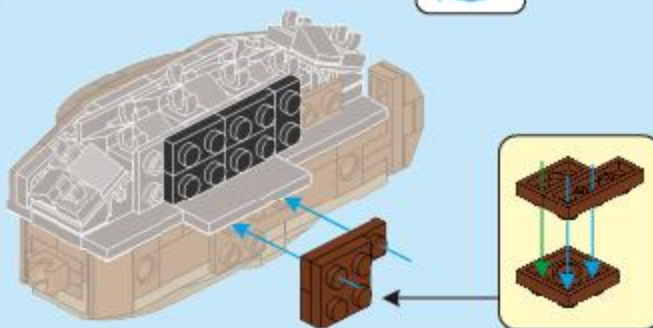
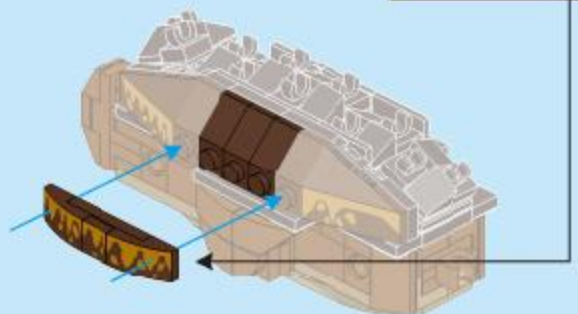



A28

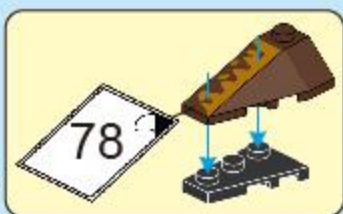
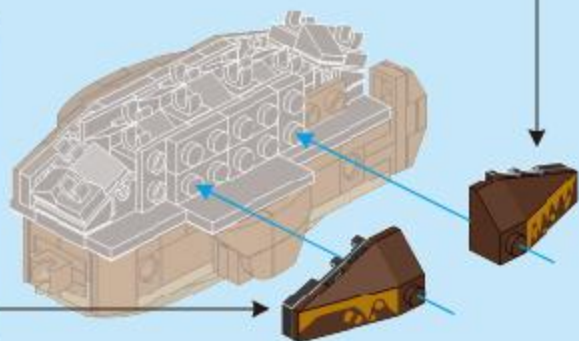
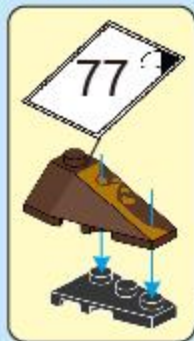

A29

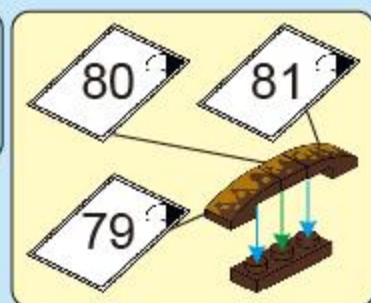
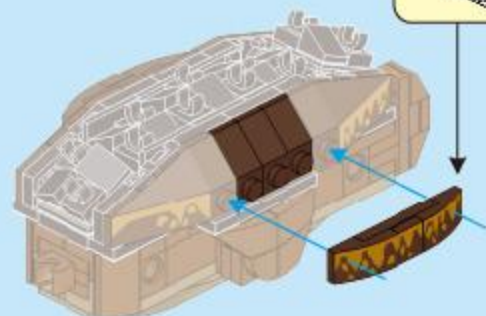

A30

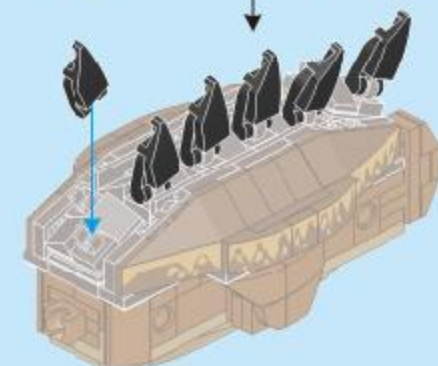

A31

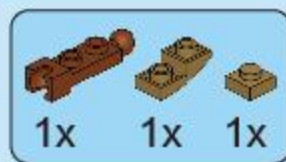

A32



A33

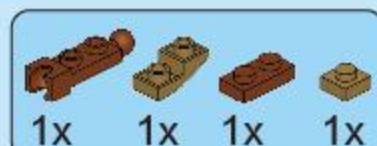
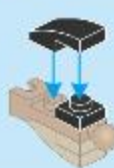

A34

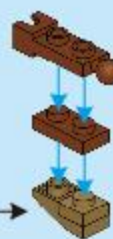

A35



A36



A37



A38



A35

A37



A39



A40



A41



A42

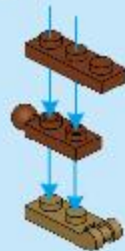
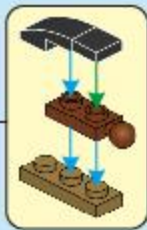
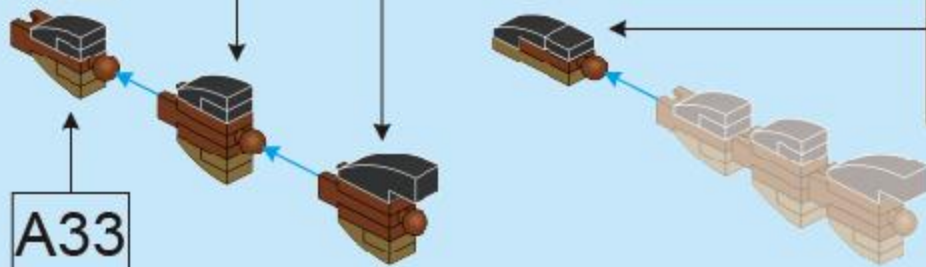

A43



A44

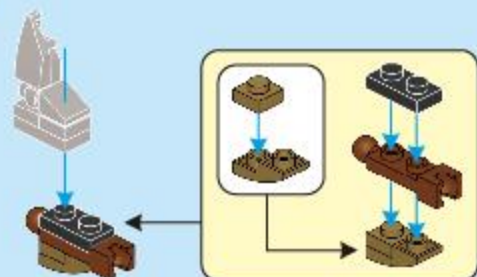
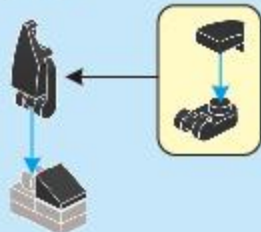

A47

A39

A31



A46

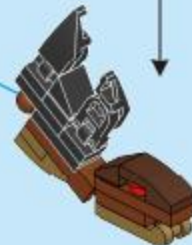
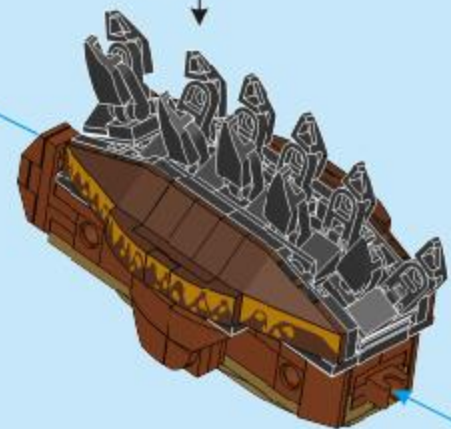

A45

A46

A41

A45

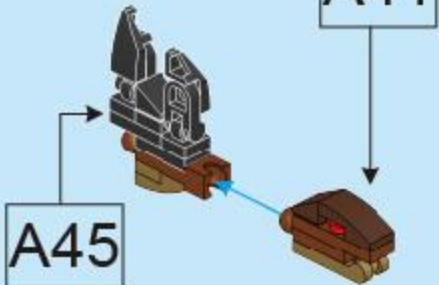



A48

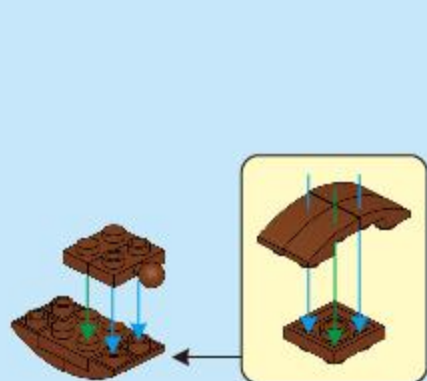

A49

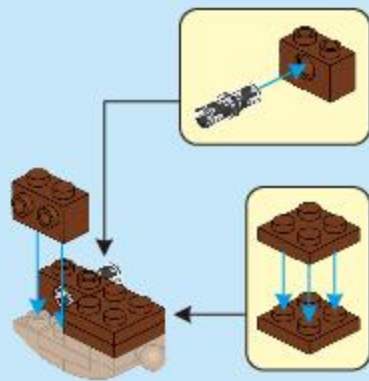

A50

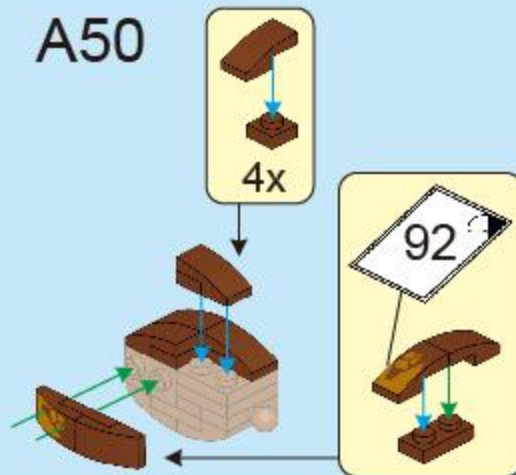

A51

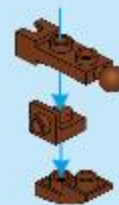

A52



A53

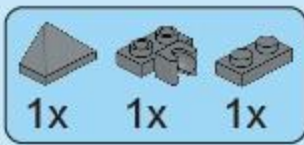
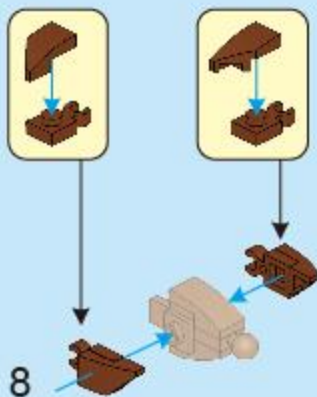

A54

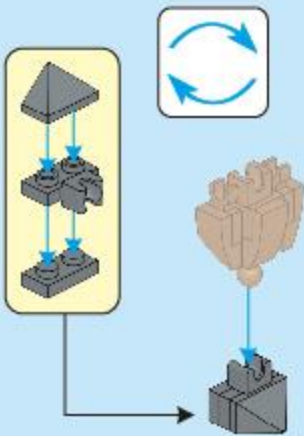

A55

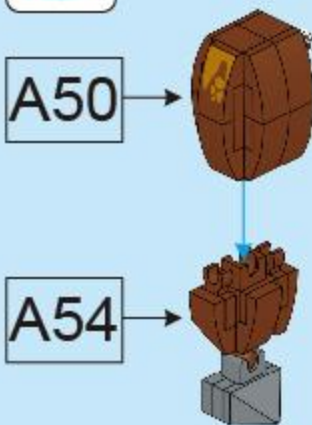

A56

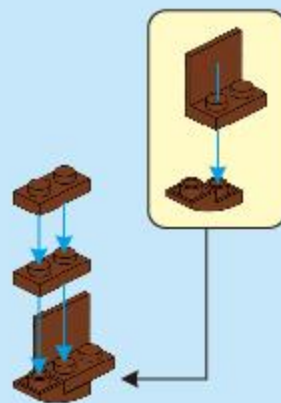

A57



A58

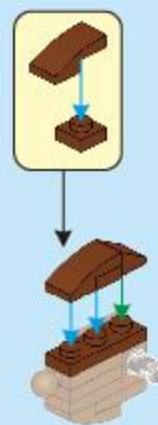



A59

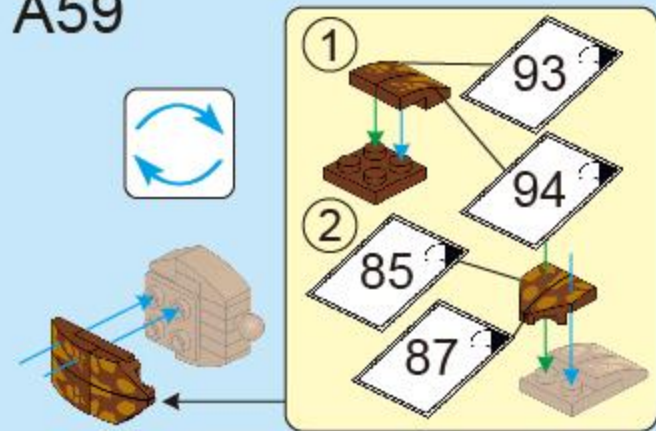

A60

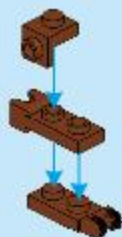

A61

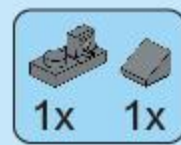
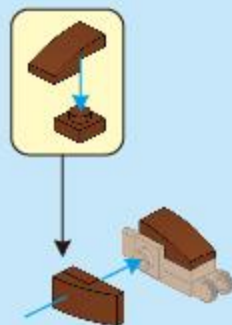

A62

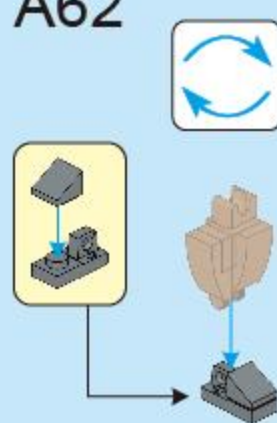

A63



A59



A62

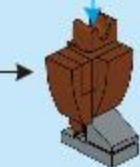

A64

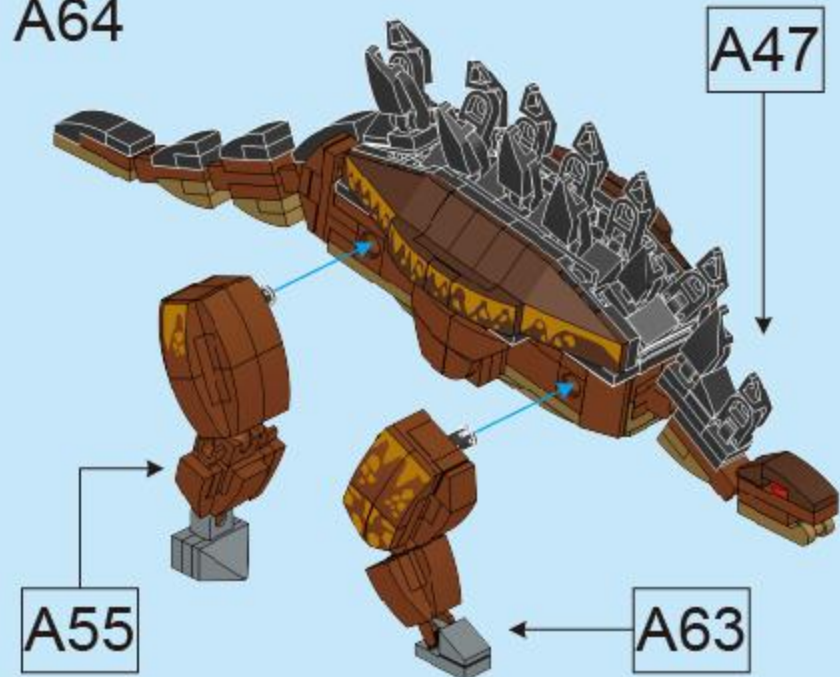

A47



A65

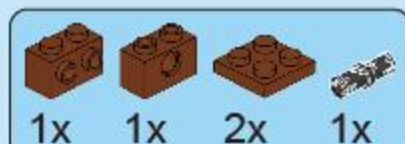

A66

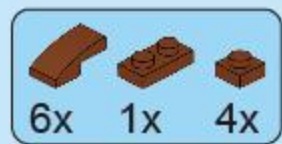
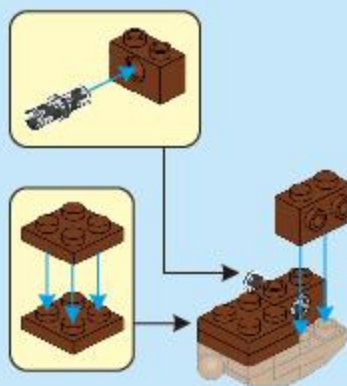

A67

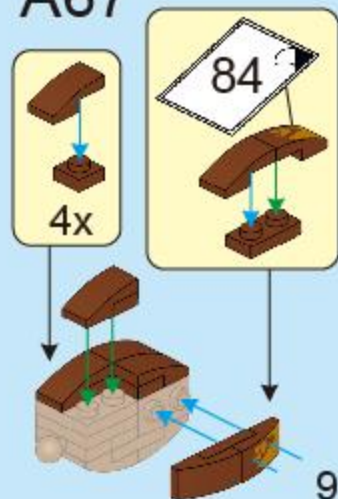

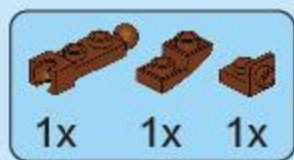

A68

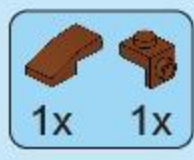
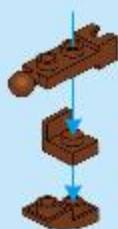

A69

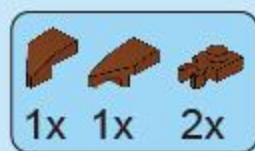

A70

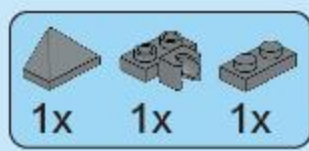
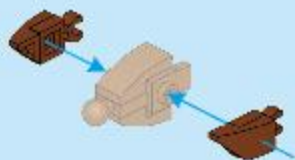

A71

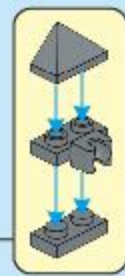

A72



A67



A71

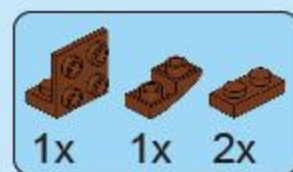

A73

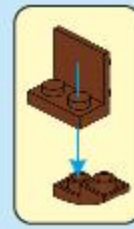

A74

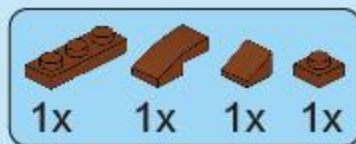

A75

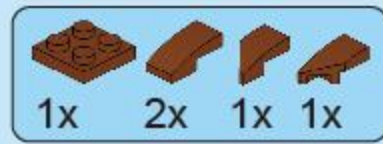
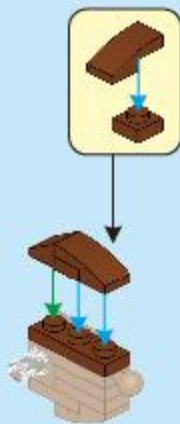

A76

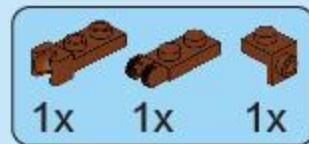
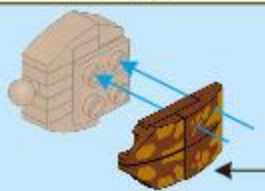
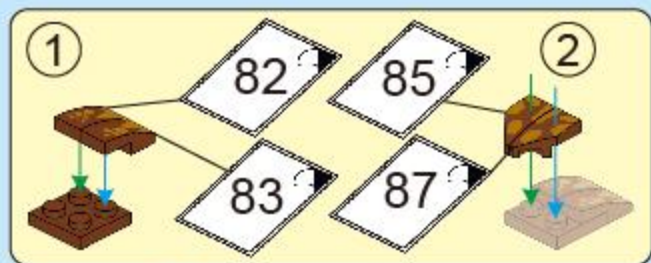

A77

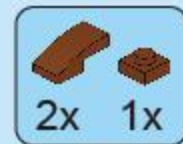
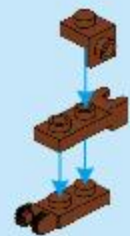

A78

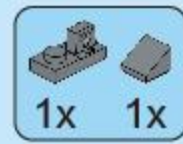
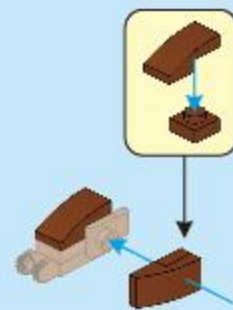

A79

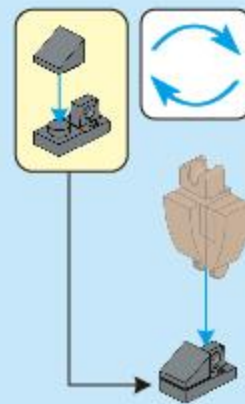

A80

A81



A

A79 A76

A64

A80

A72

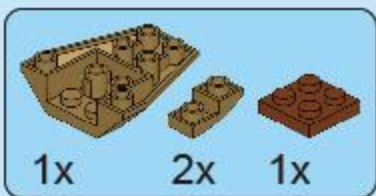
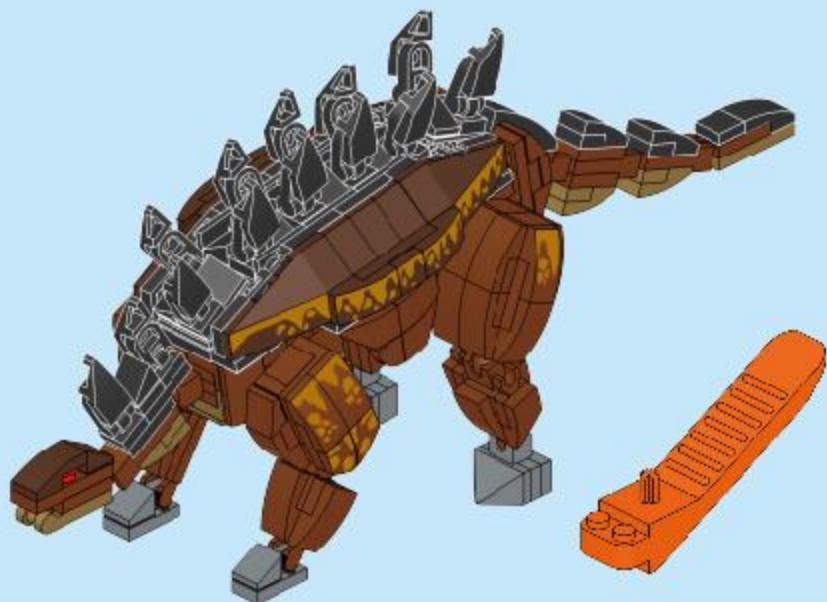
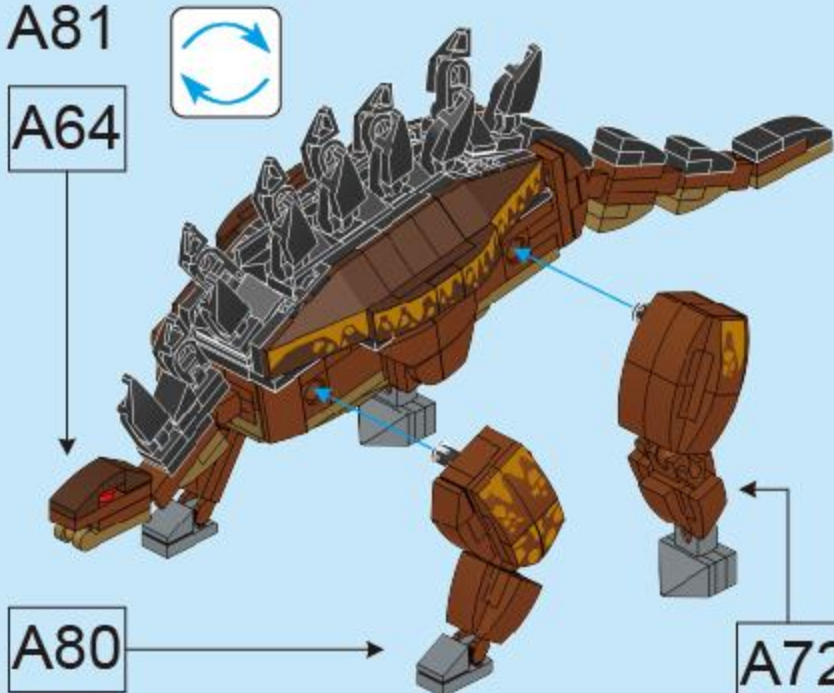
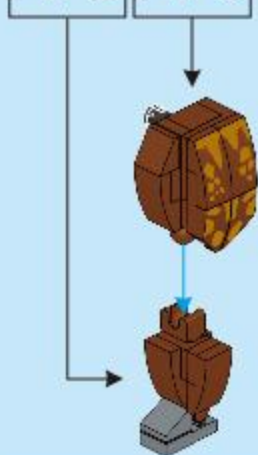

B1



B2

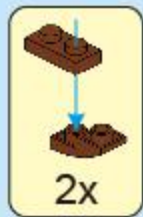

B3

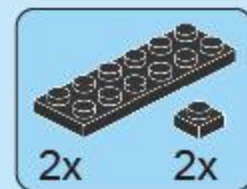

B4

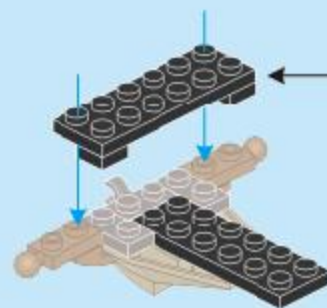
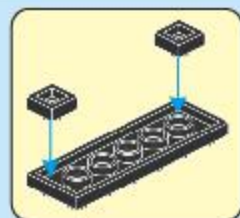



B5

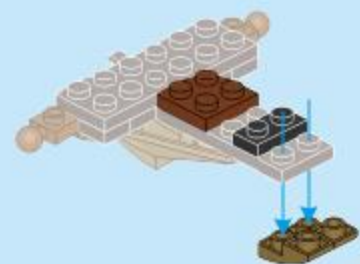

B6

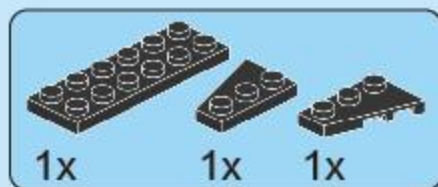
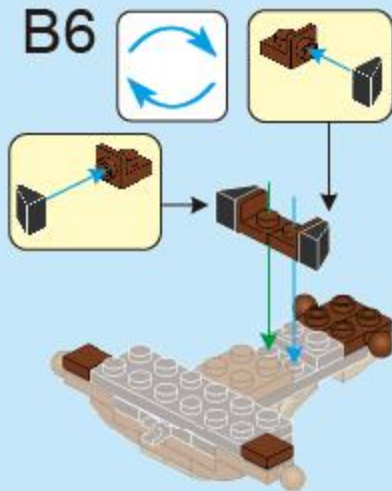

B7

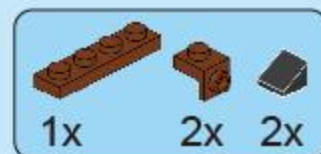
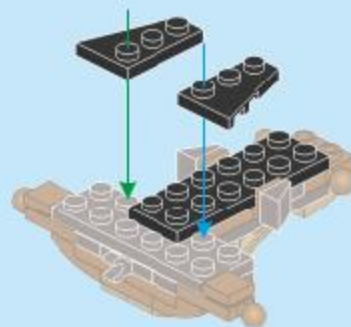

B8

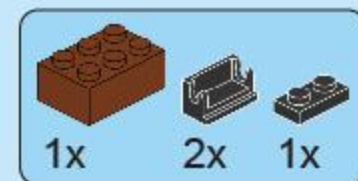
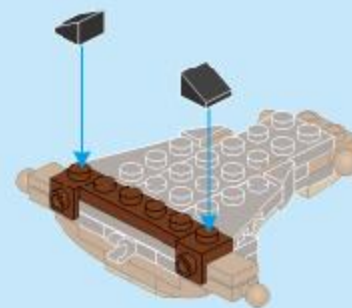

B9

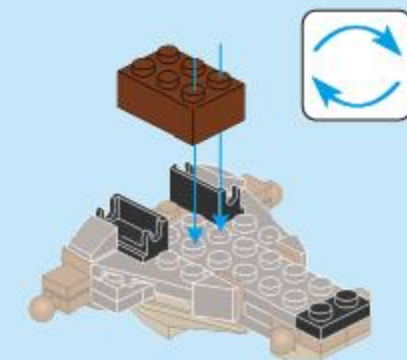

B10



12



B11

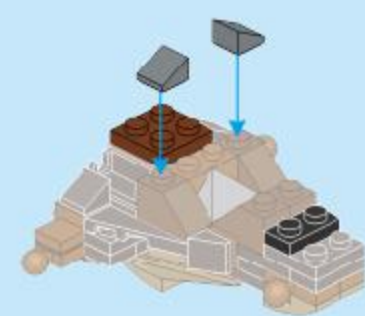

B12



B13

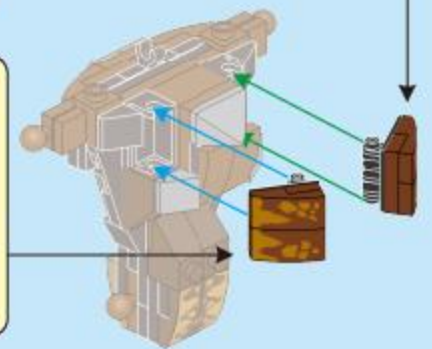
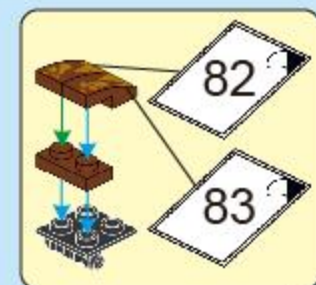



B14

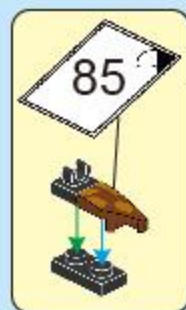

B15

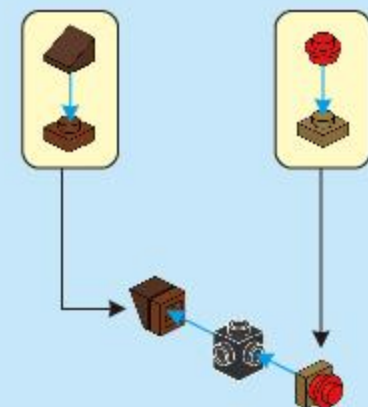

B16

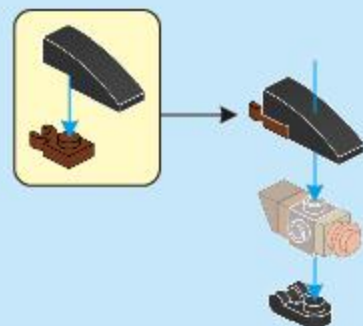

B17



B18

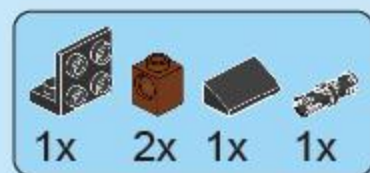
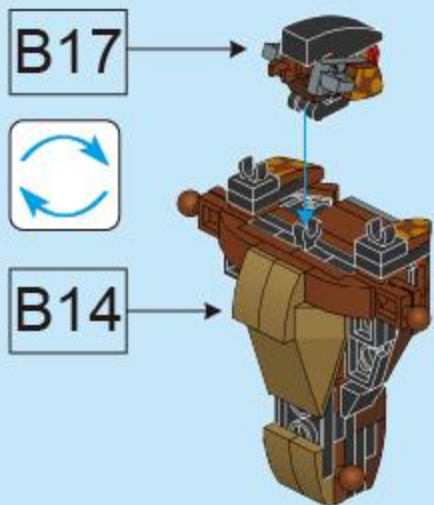

B19

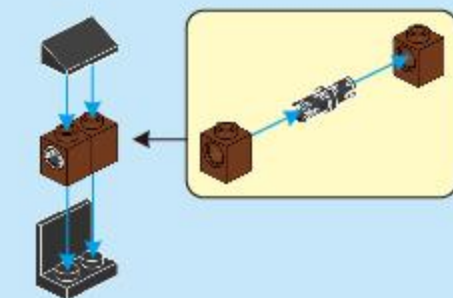

B20

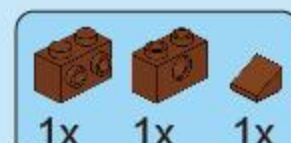
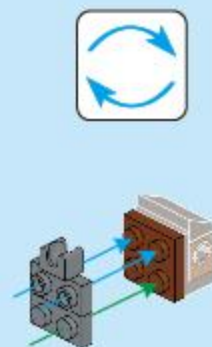

B21

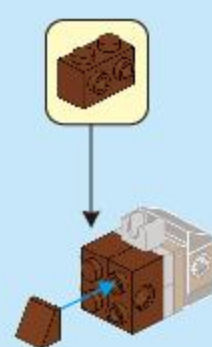

B22

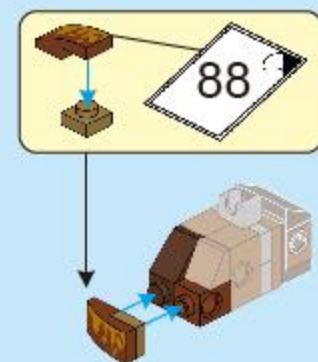



B23

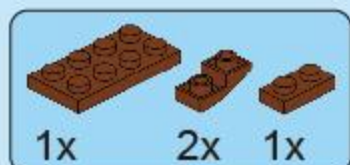
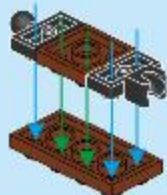

B24

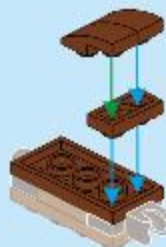

B25

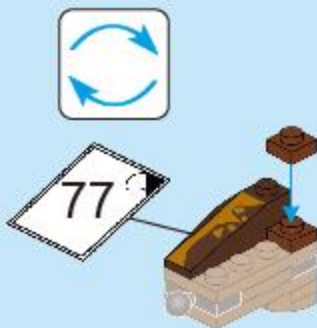

B26

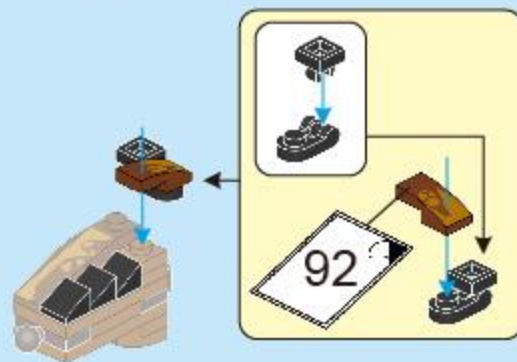

B27

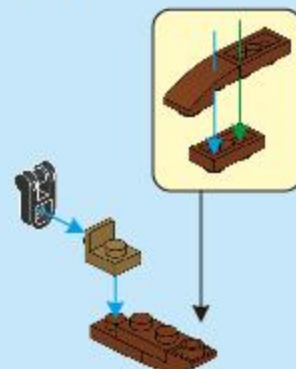

B28



B29



B30

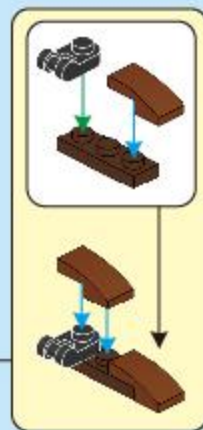
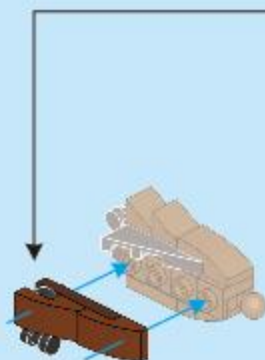

B31

B30



B26

B22





B32

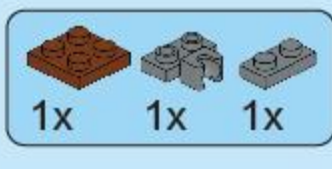
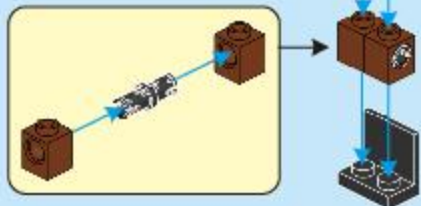

B33

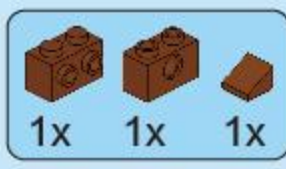
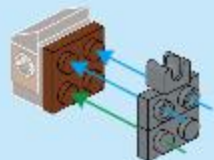

B34

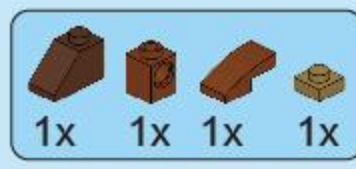
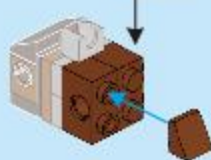

B35

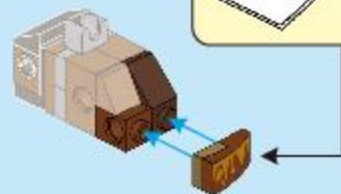
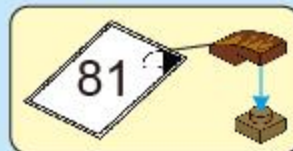

B36

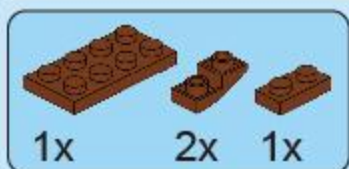
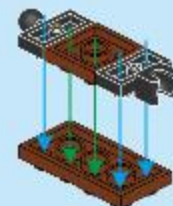

B37

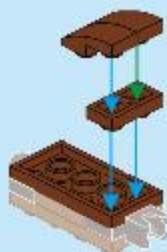

B38



B39

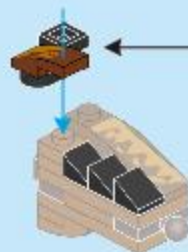
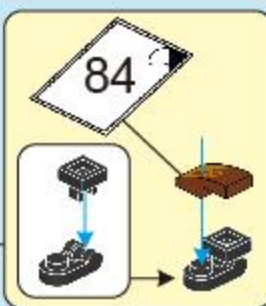

B40

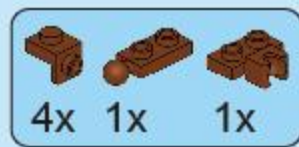
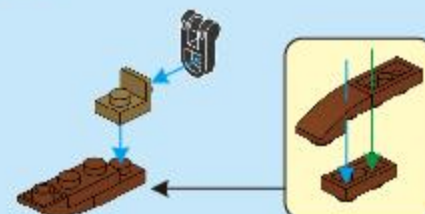

B41



B42



B43

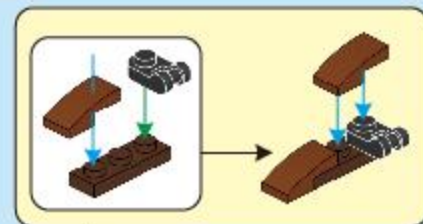
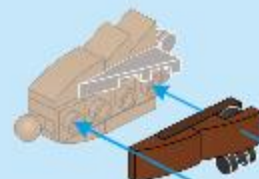

B44

B43



B39

B35



B45

B18



B31

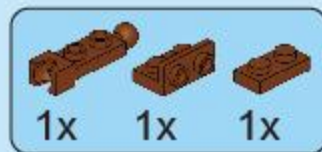
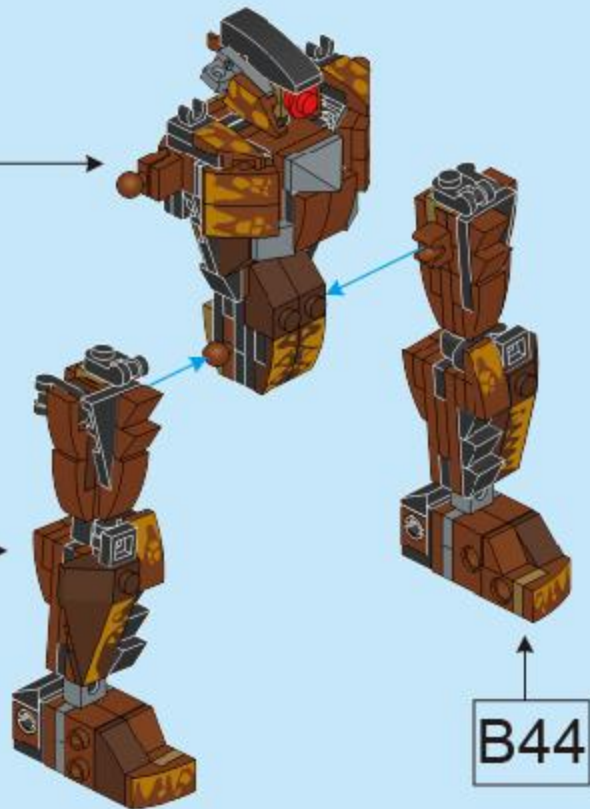

B46



B47

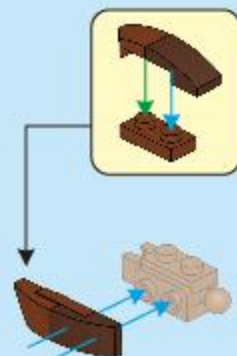
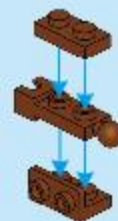

B48

16

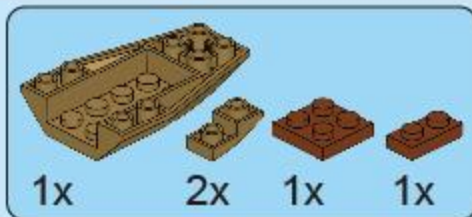
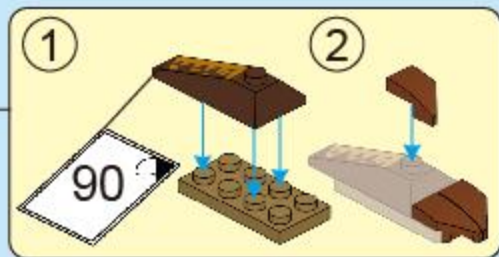
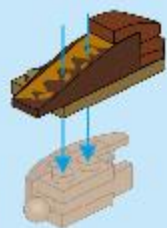

B49

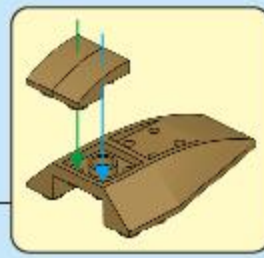
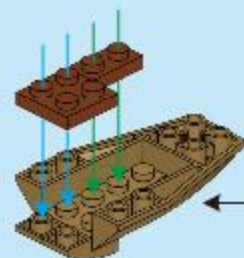

B50

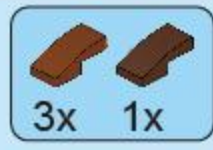
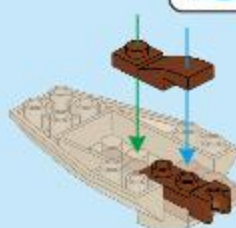

B51

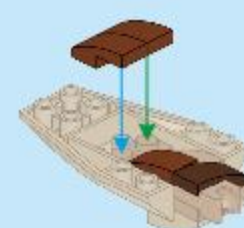

B52

B48



B51

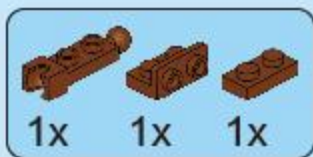

1x 1x 1x

B53

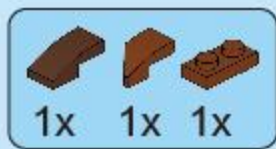
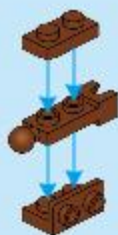

1x 1x 1x

B54

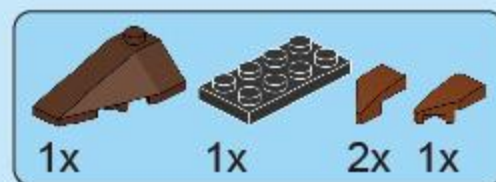
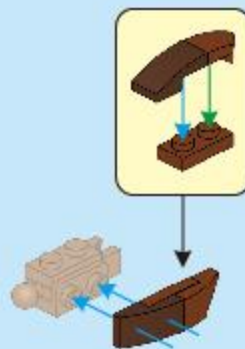

1x 1x 2x 1x

B55

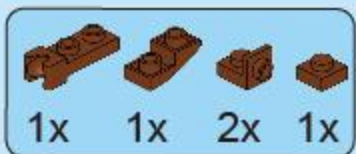
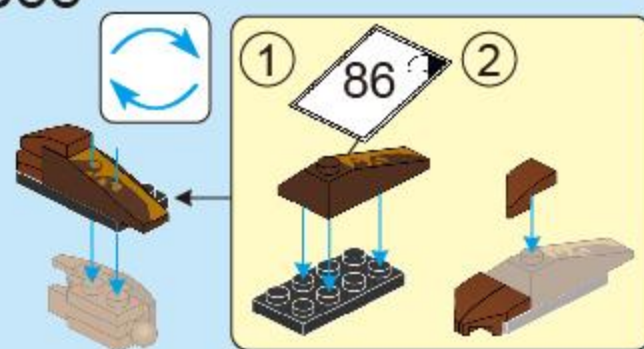

1x 1x 2x 1x

B56

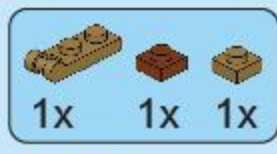
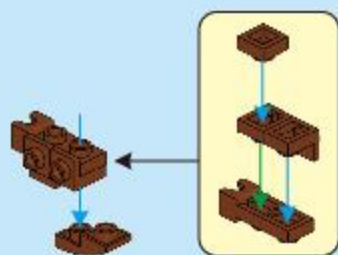

1x 1x 1x

B57

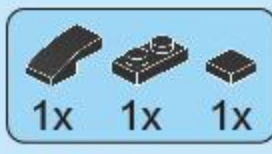

1x 1x 1x

B58

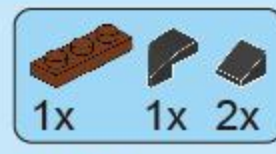
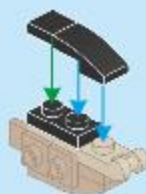

1x 1x 2x

B59

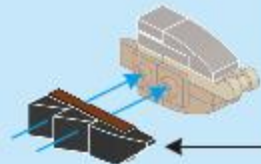

B60



B55

B59



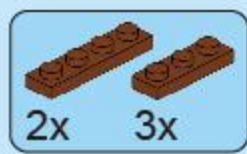

B61

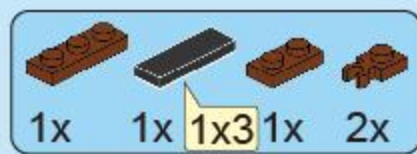
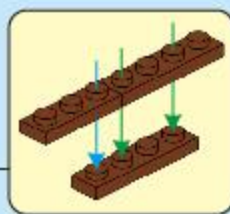
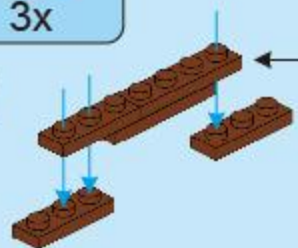

B62

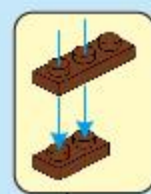
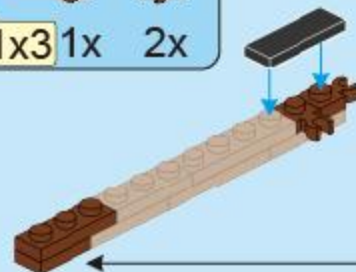

B63

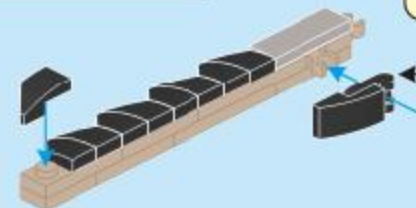

B64

B65

B

B60



B63

18

B45



B64

B52

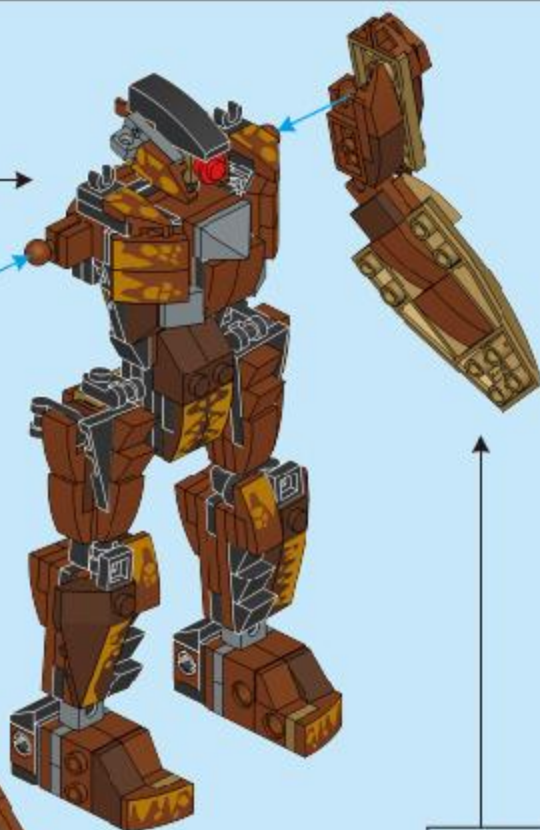
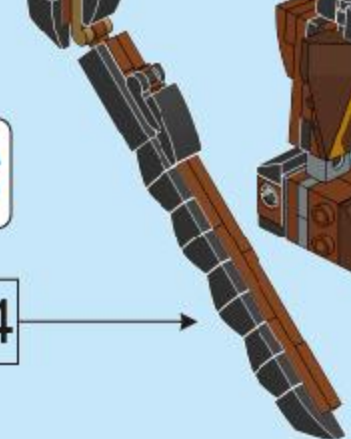
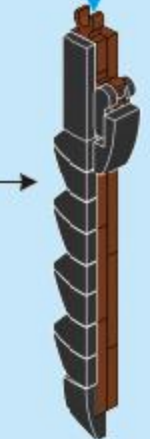

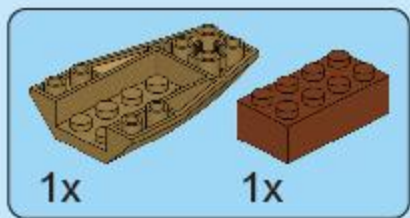

C1

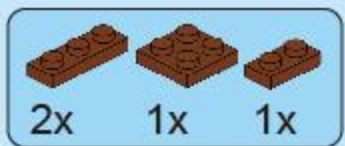
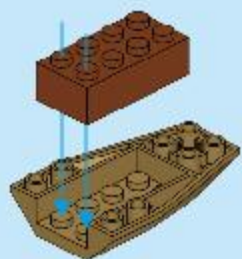

C2

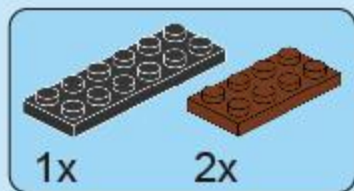
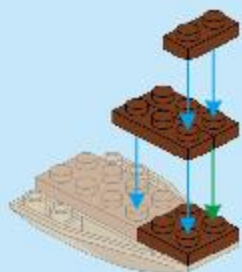

C3

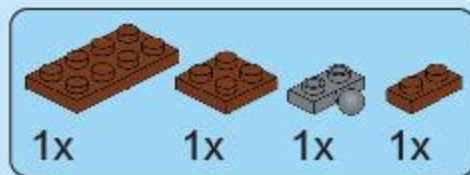
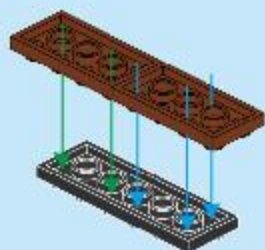

C4



C5

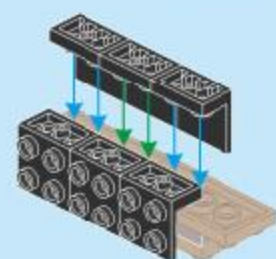

C6

C2

C5

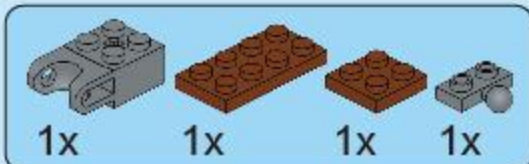
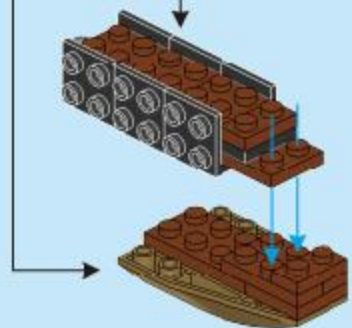

C7

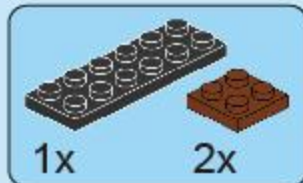
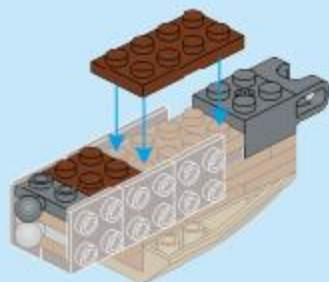

C8

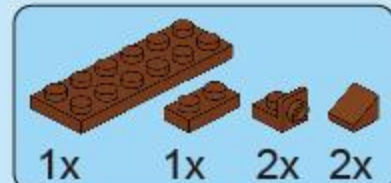
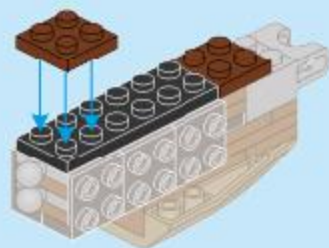

C9

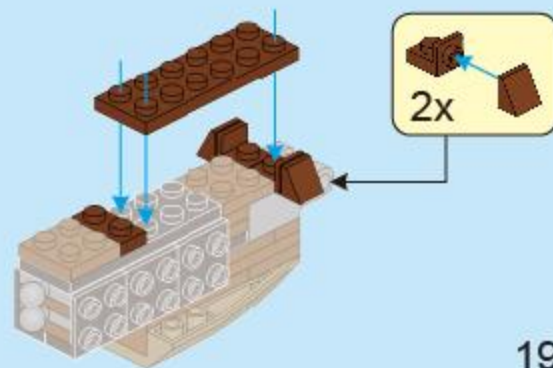



C10

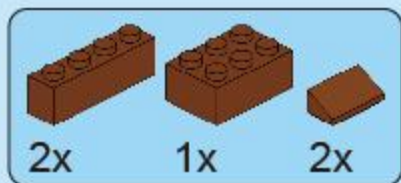
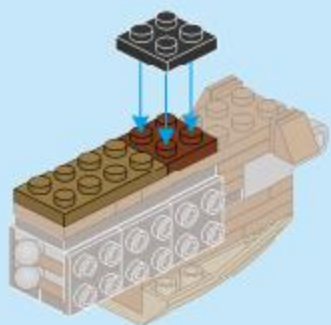

C11

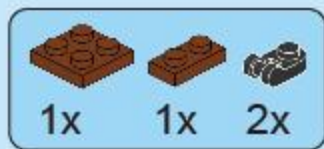
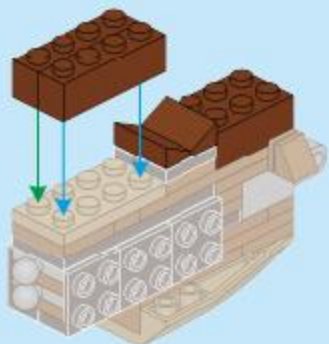

C12

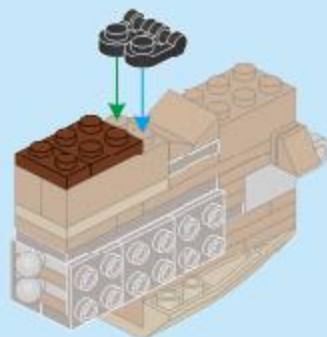

C13

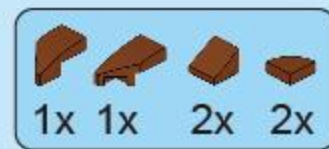
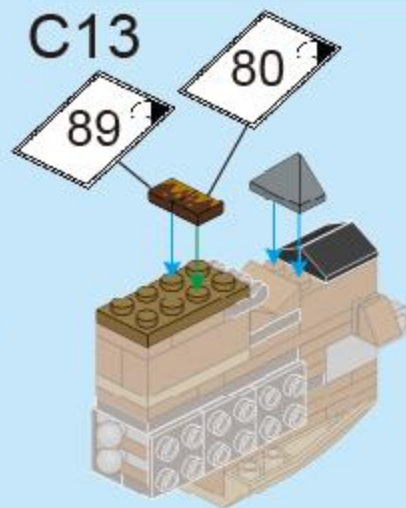

C14

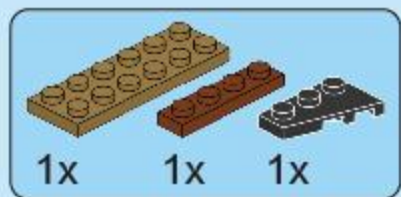
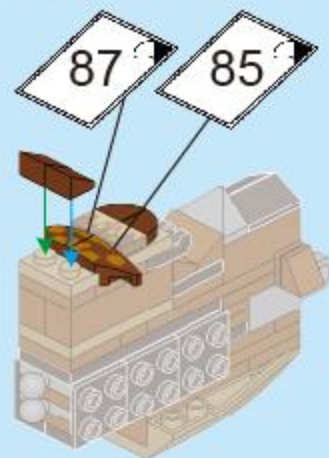

C15

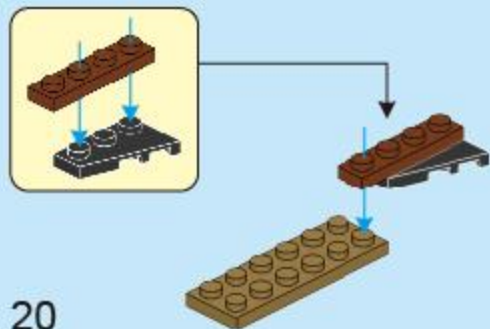

C16

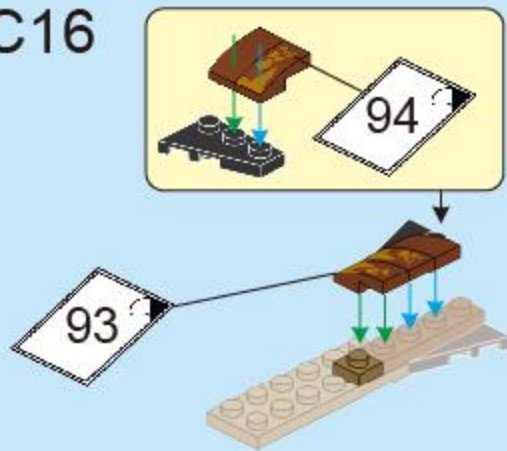

C17

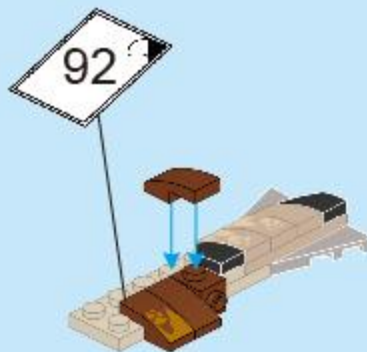

C18

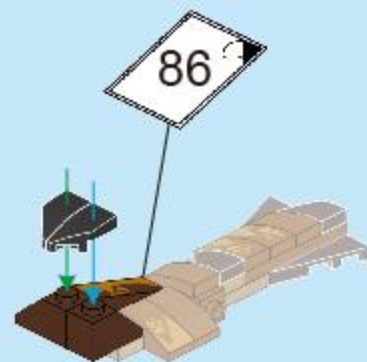



C19

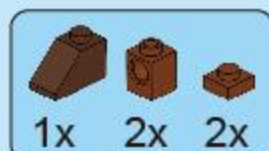
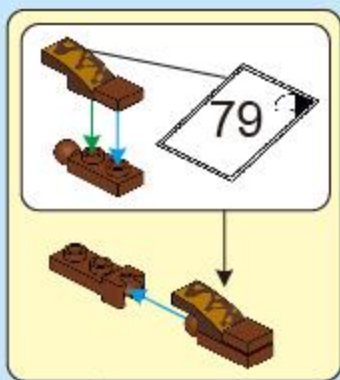
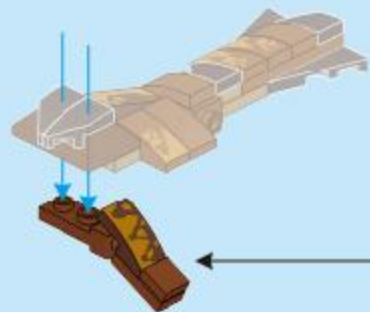

C20

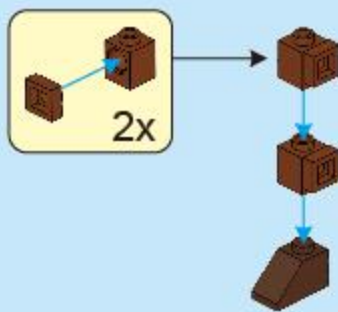

C21

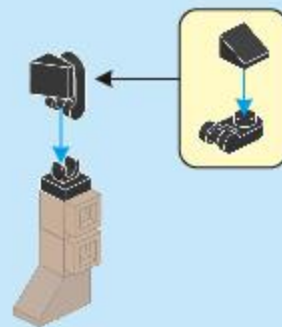

C22

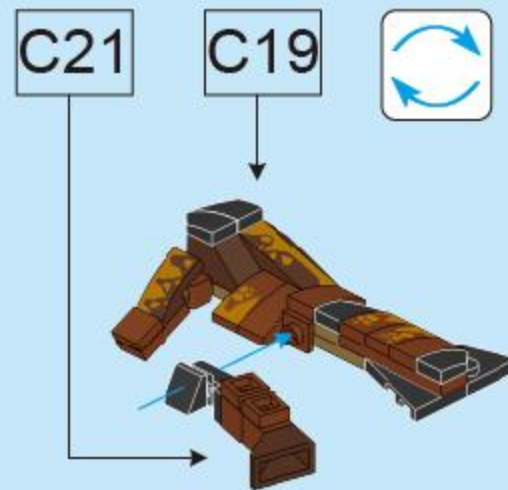

C23

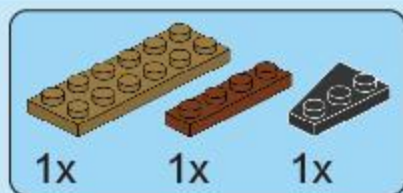
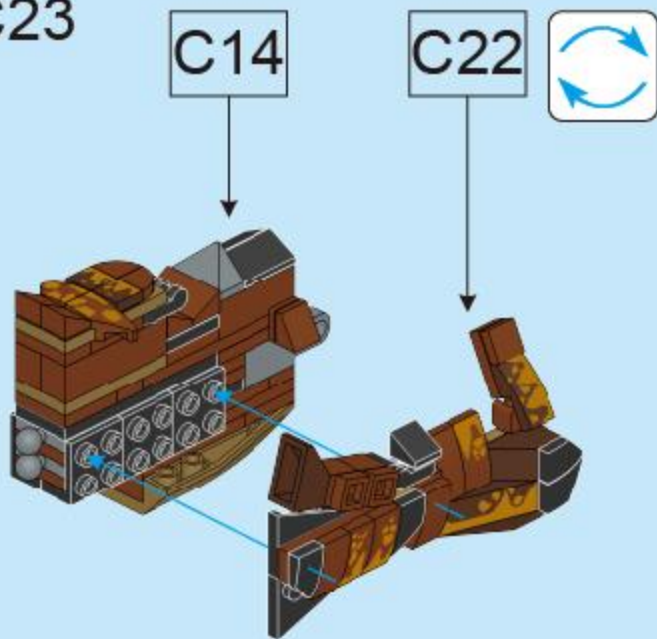

C24

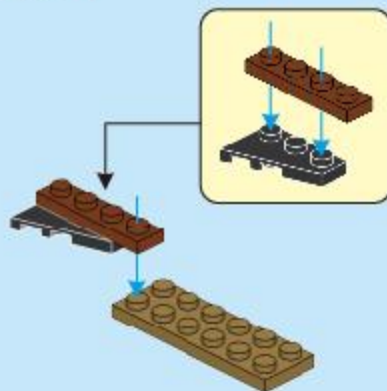

C25

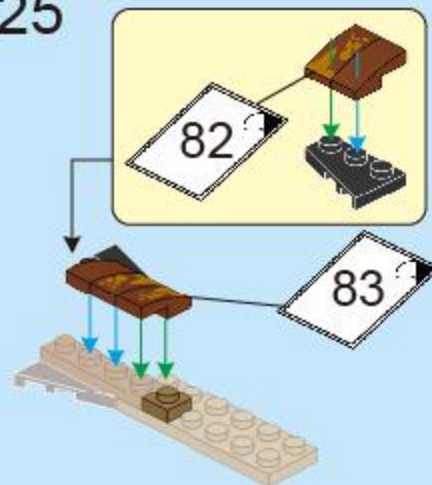

C26

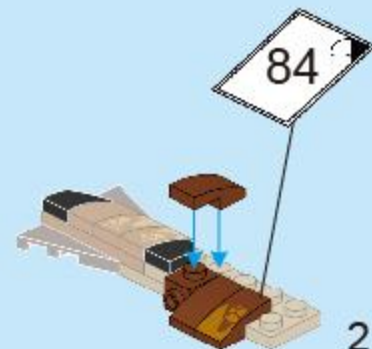



C27

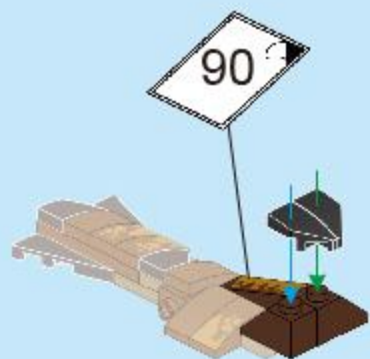

C28

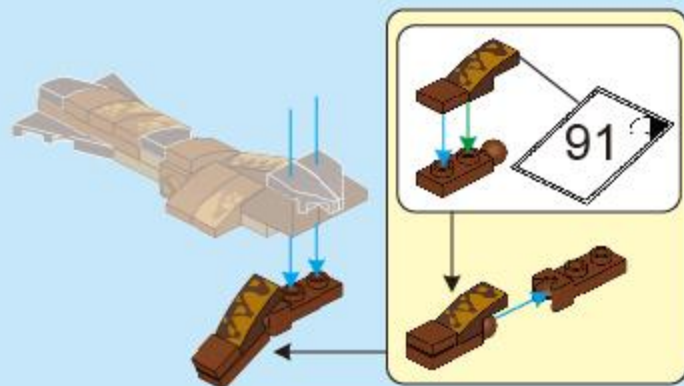

C29

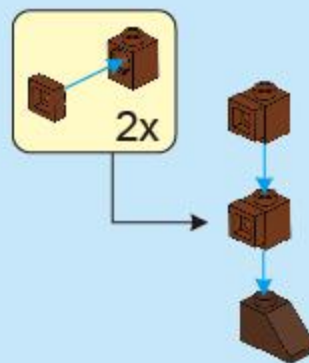

C30

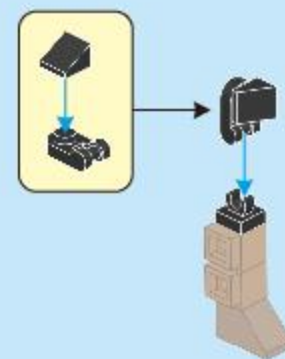

C31

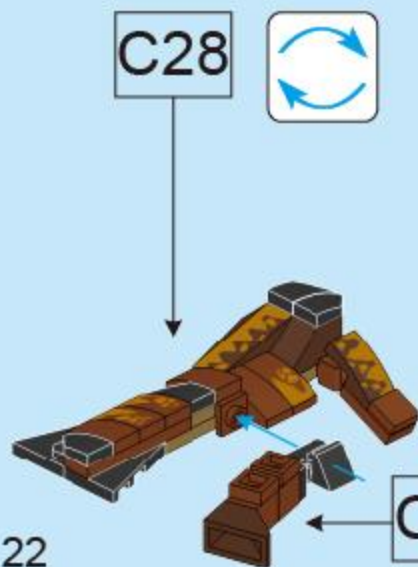

C32

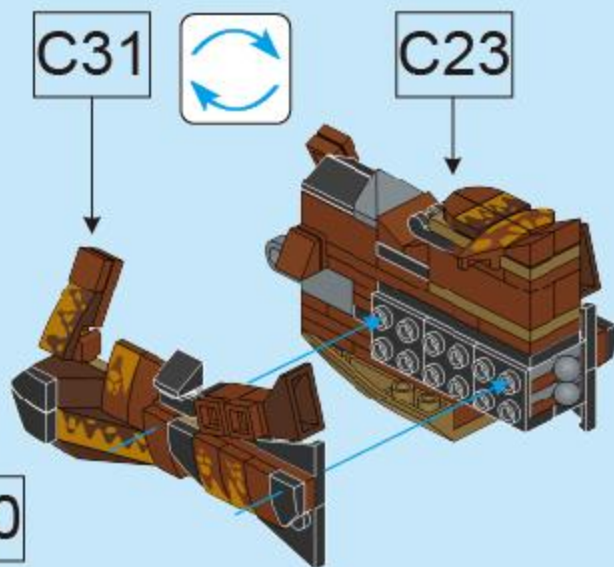

C33

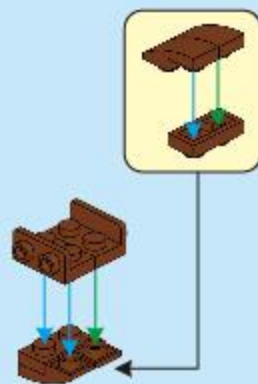

C34



C35



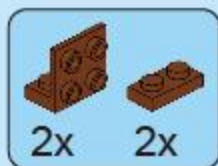

C36

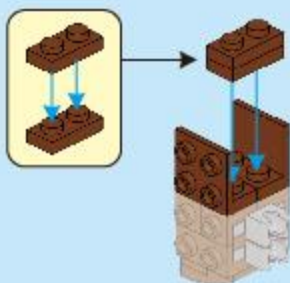

C37

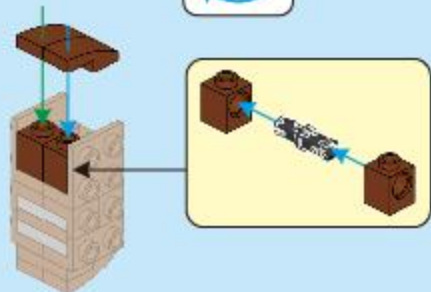

C38

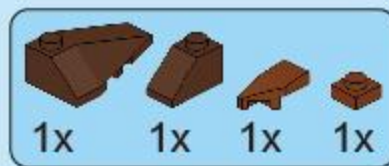
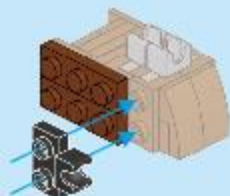

C39

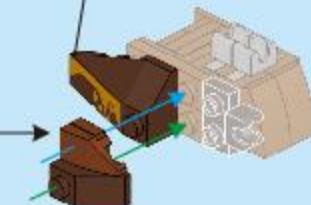
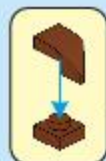

C40

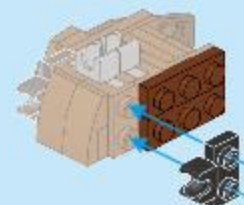

C41

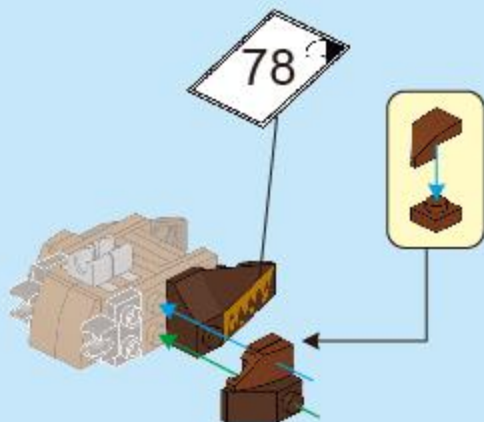

C42

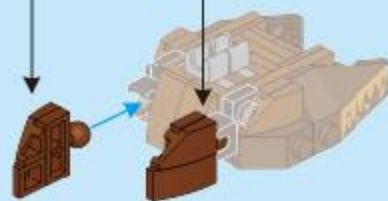
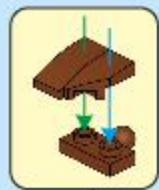

C43

C32



C42

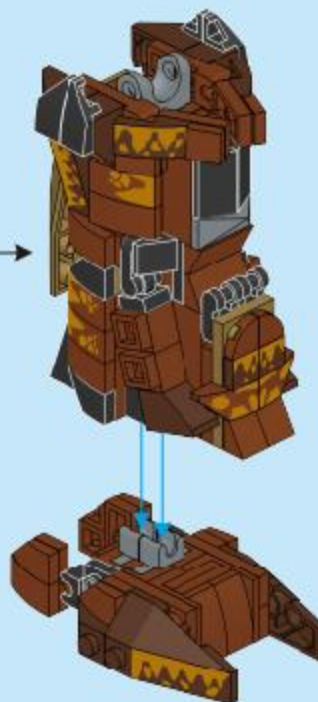

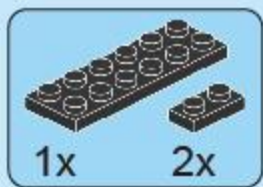

C44

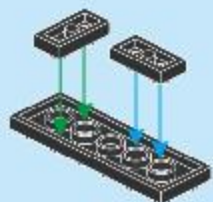

C45

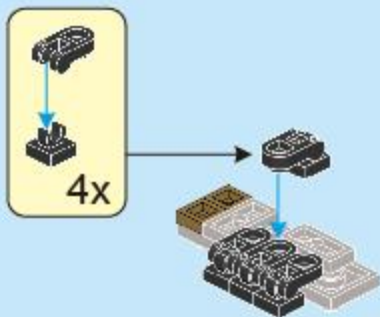

C46

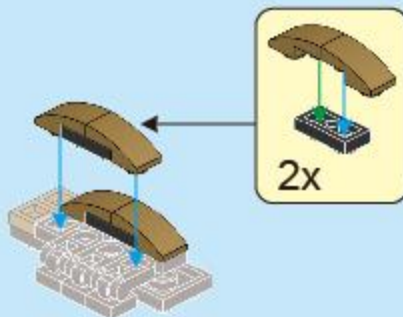

C47

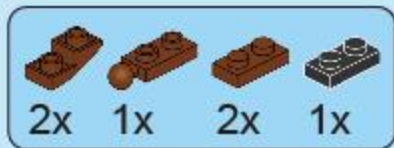
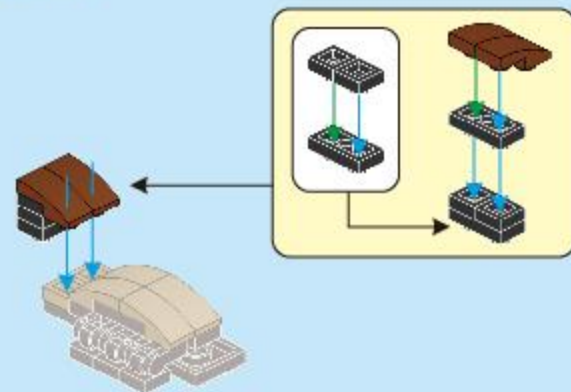

C48

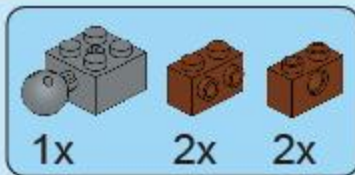
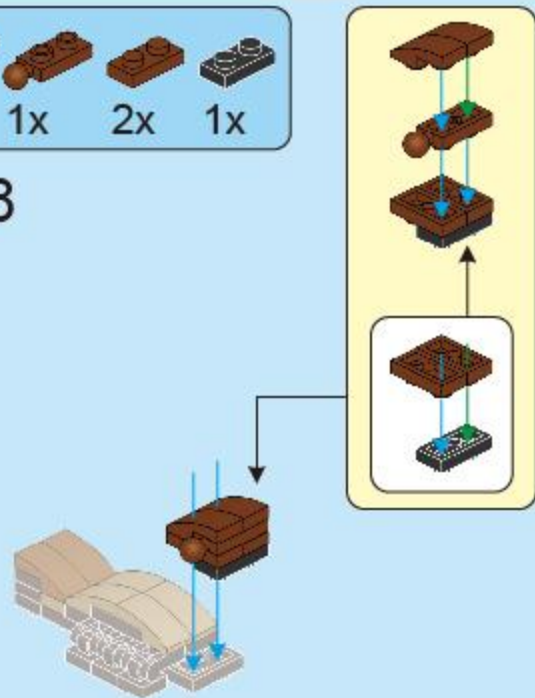

C49

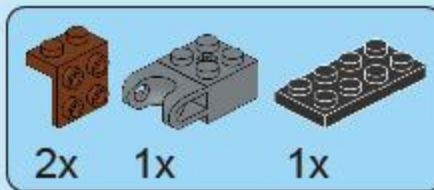
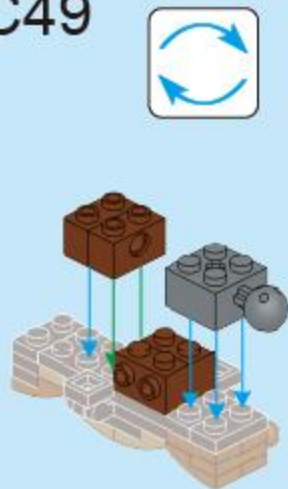

C50

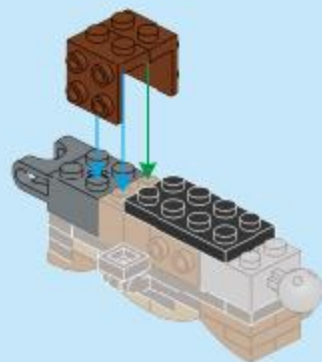

C51

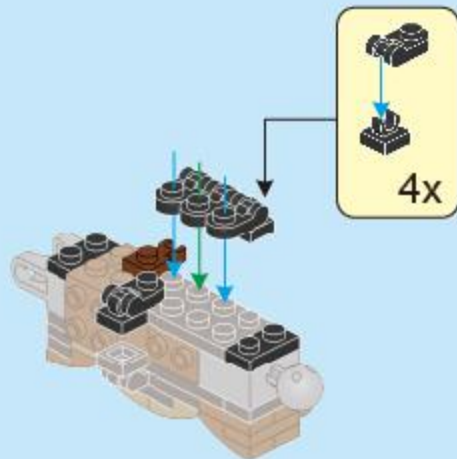



C52

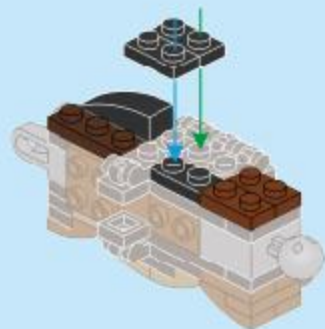

C53



C54

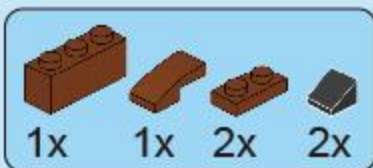
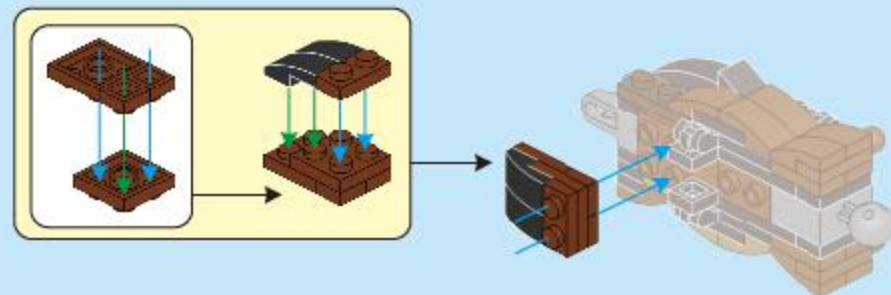

C55

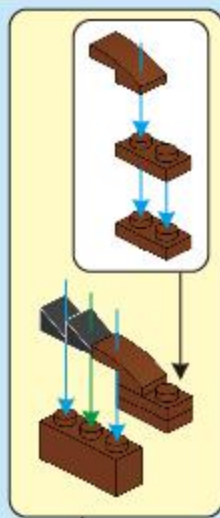
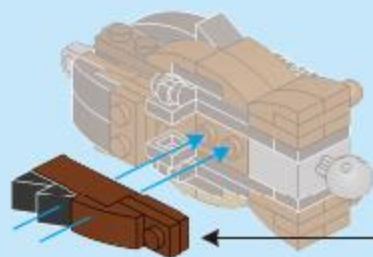

C56

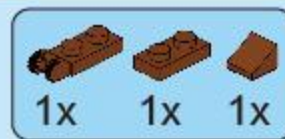
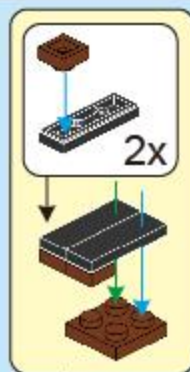
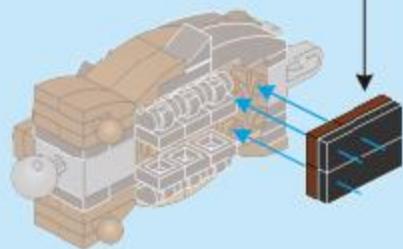

C57

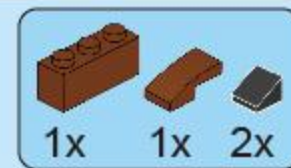
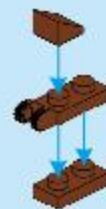

C58

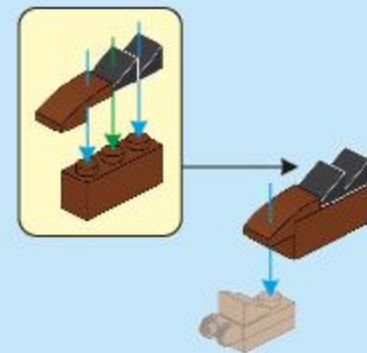

C59



C56

C58

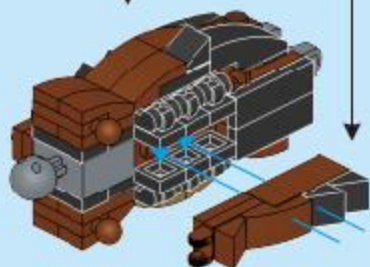

C60

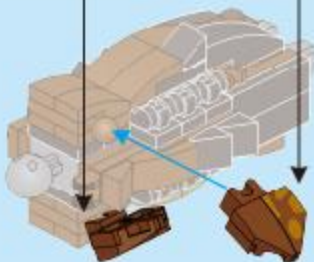
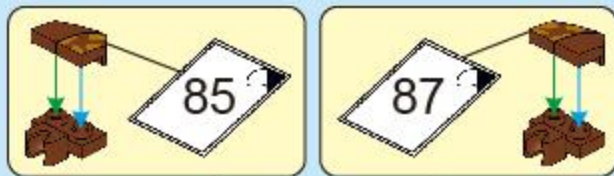

C61

C

C60



C43



FC1021C

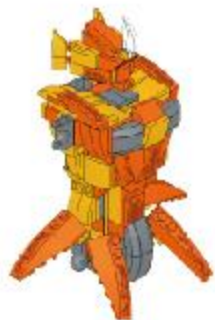

FC1022C



FC1024C



FC1023C



FC1025C

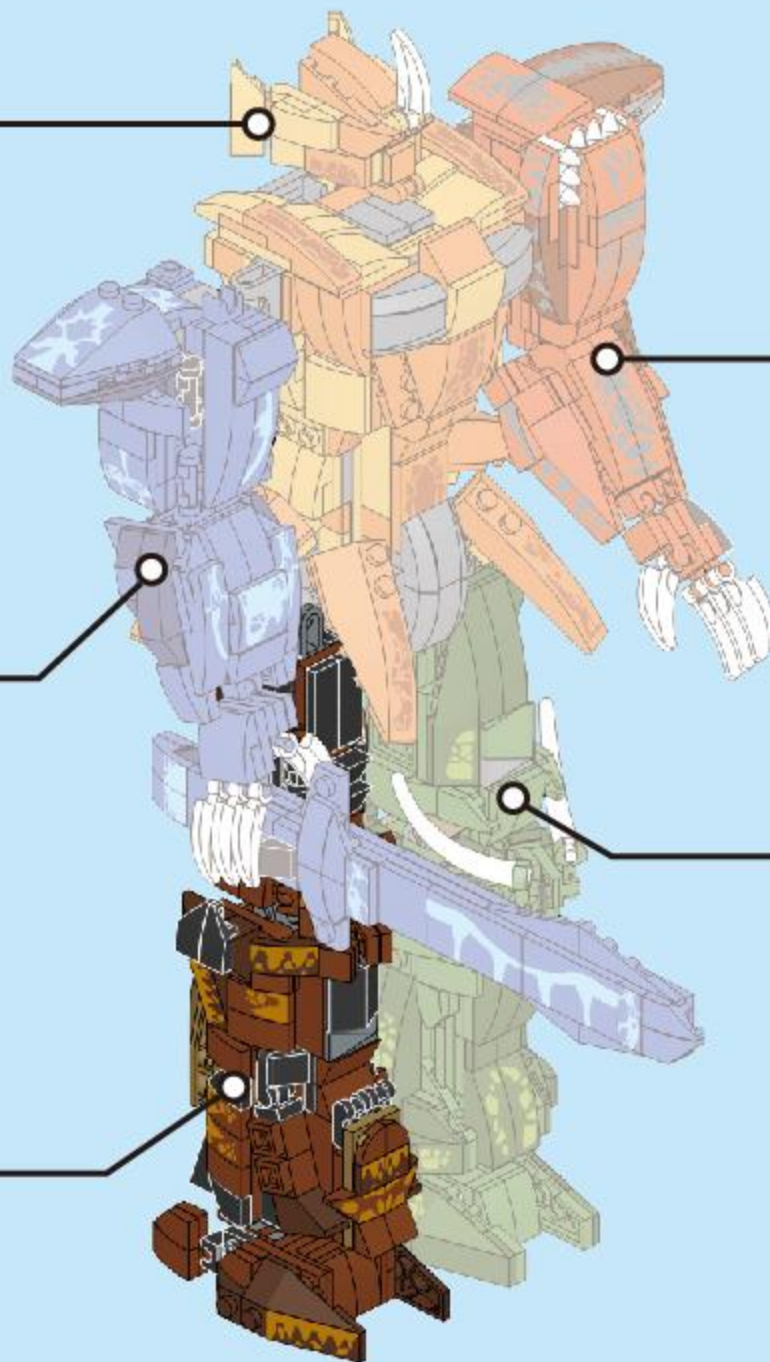

2 IN 1
TRANSFORMS



TECHNIC 2 IN 1 TRANSFORMS

 COLLECT 5 MODELS
TO COMBINE ZEUS MARS