

FC1025

**2 IN 1**  
TRANSFORMS



COLLECT 5 MODELS  
TO COMBINE ZEUS MARS

拆件器使用方法，仅为示例

Usage of Brick Separator, Just for the sample

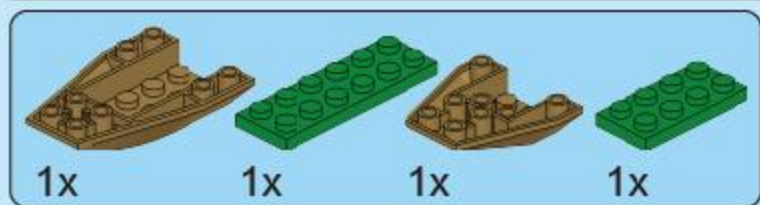
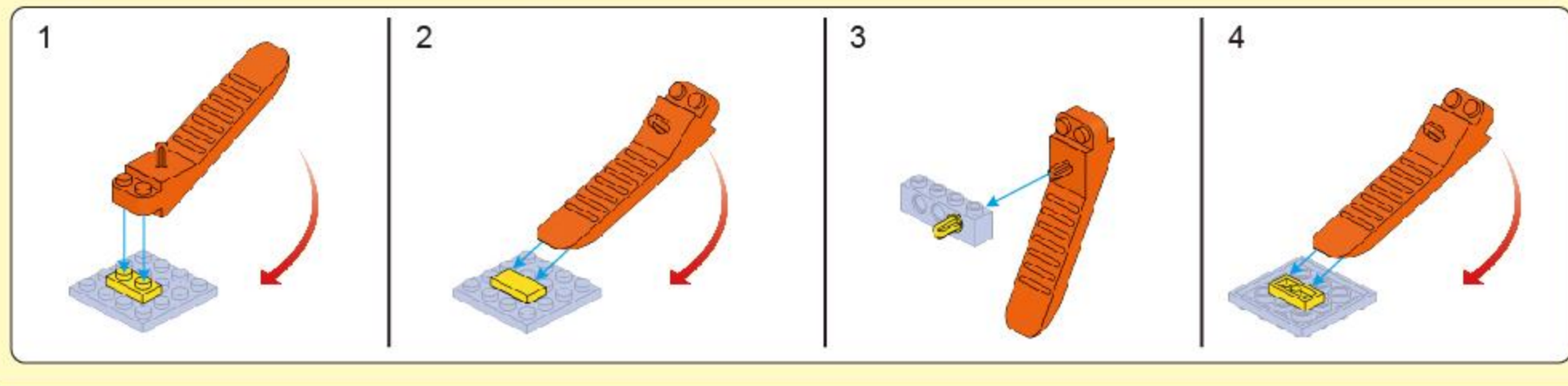

A1



A2

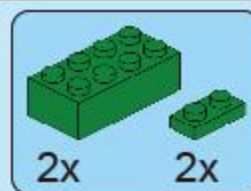

A3

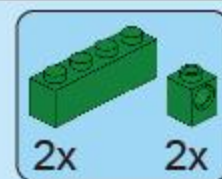

A4

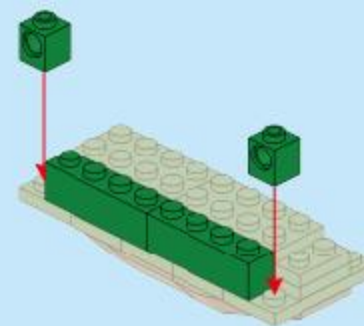
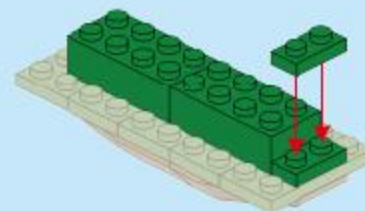
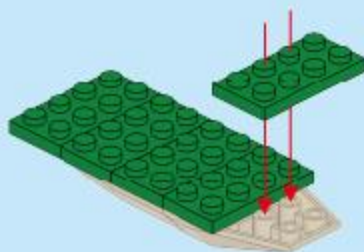
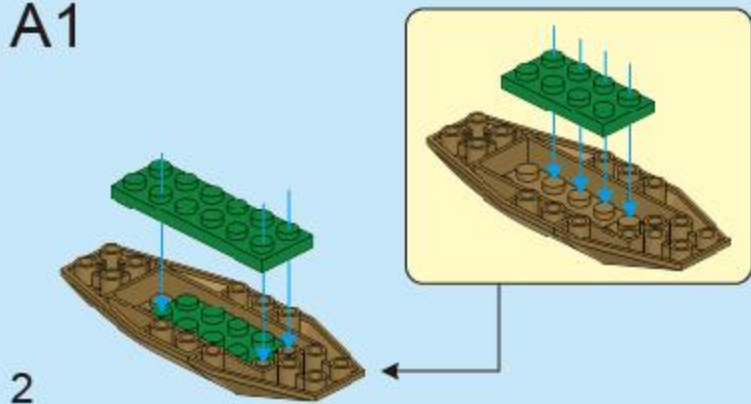

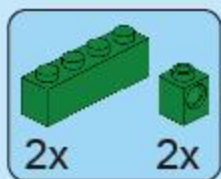

A5

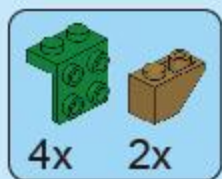
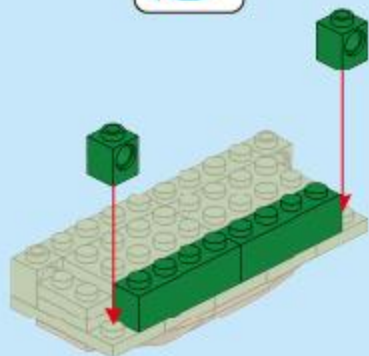

A6

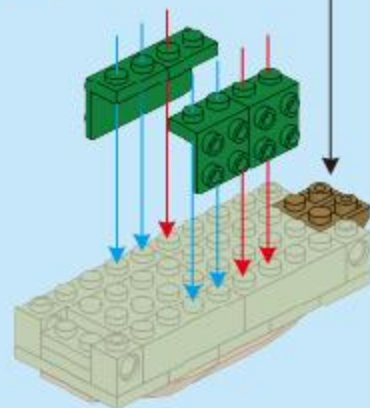

A7

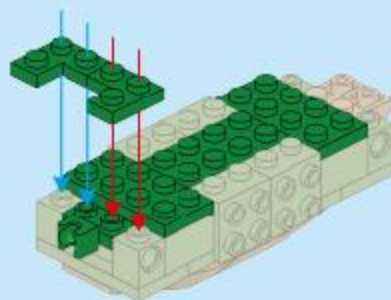

A8

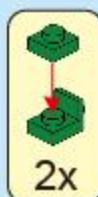
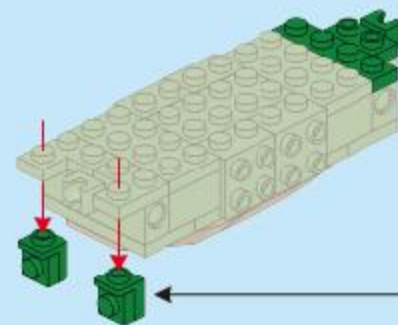

A9

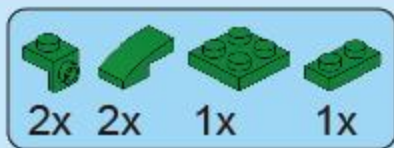
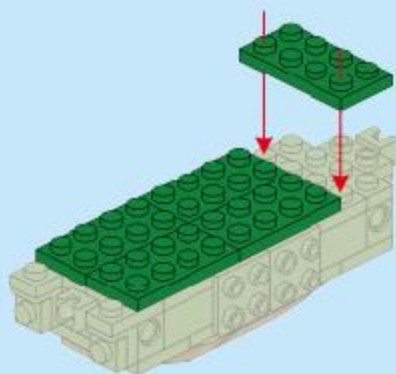

A10

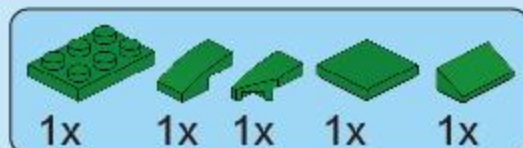
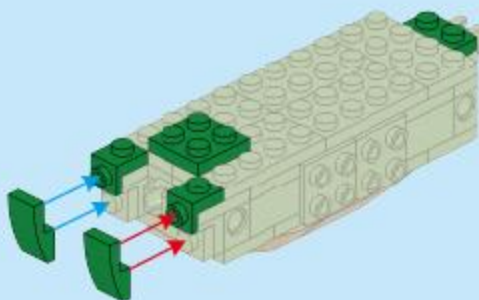

A11

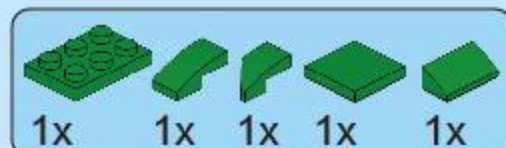
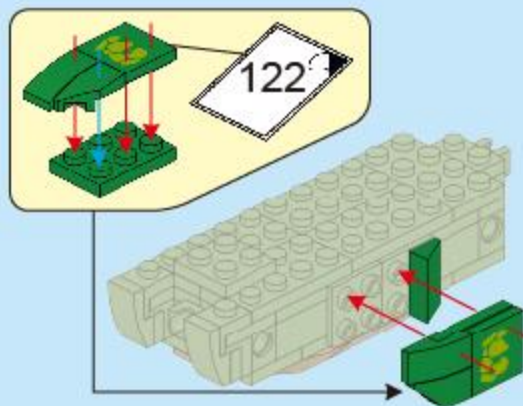

A12

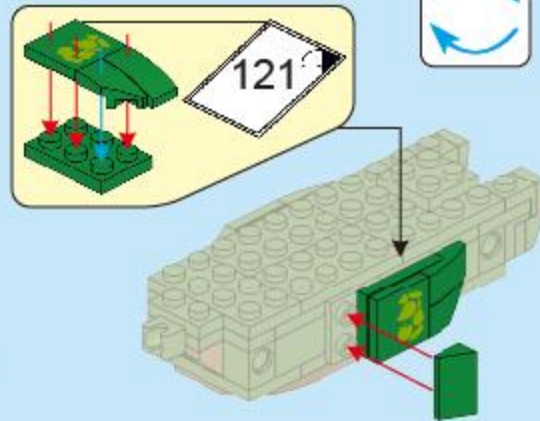

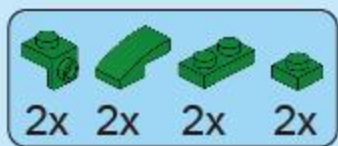

A13

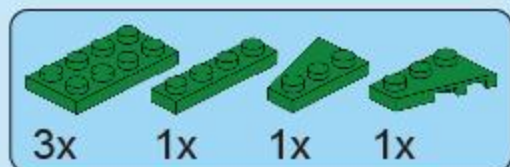
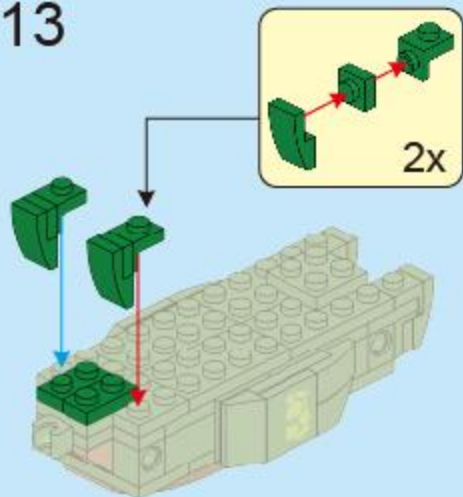

A14

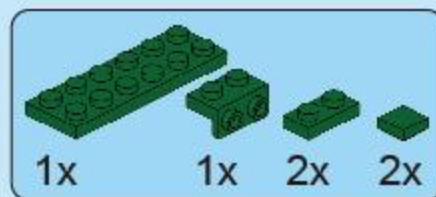
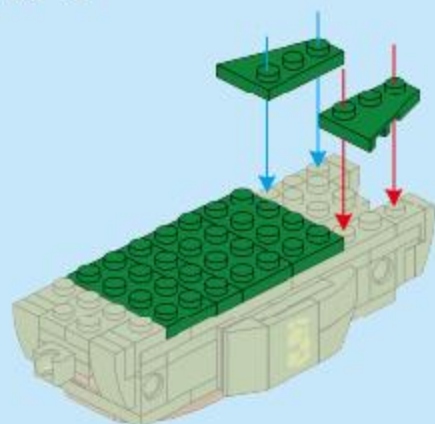

A15

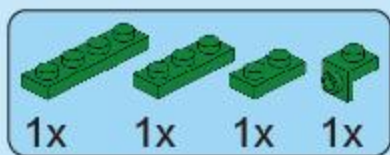
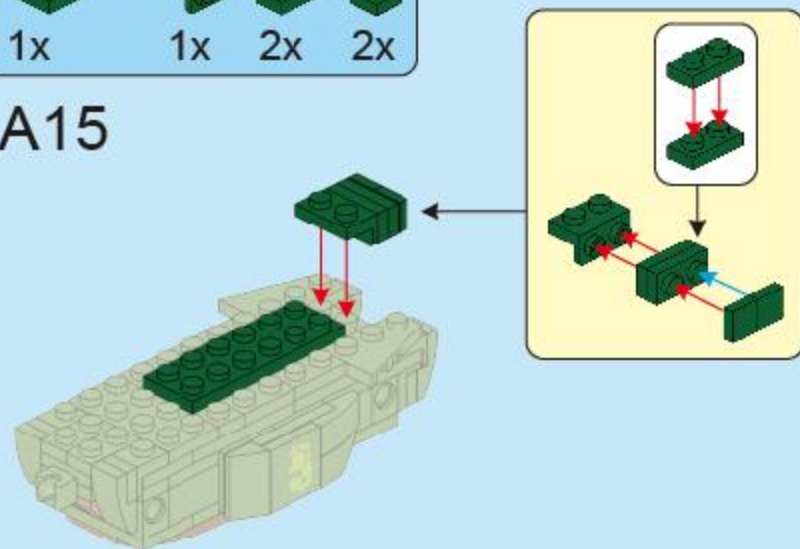

A16

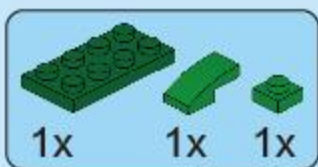
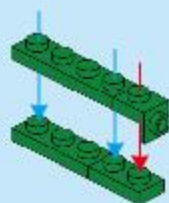

A17

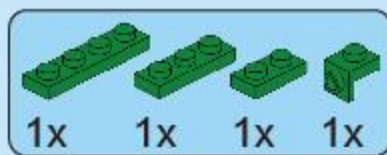
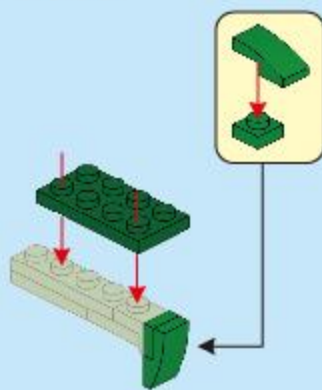

A18

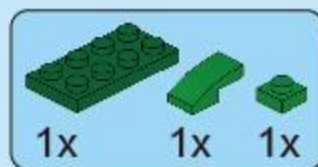
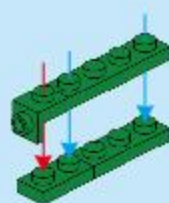

A19

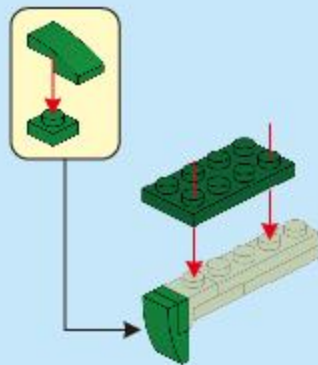

A20

A17

A19

A15

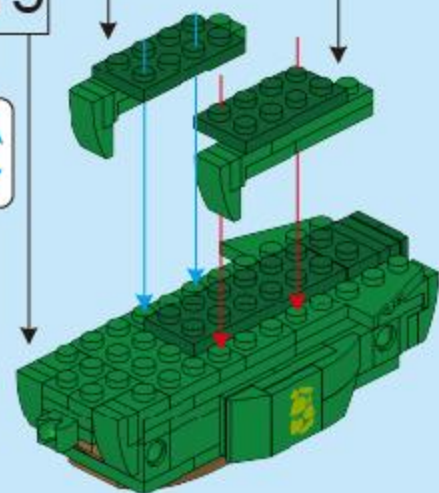

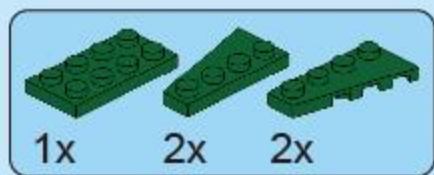

A21

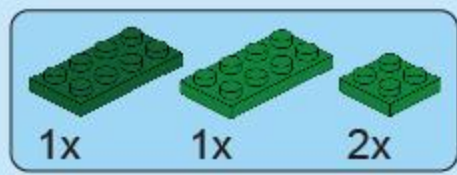
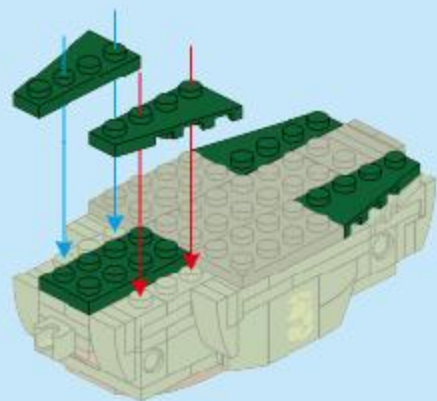

A22

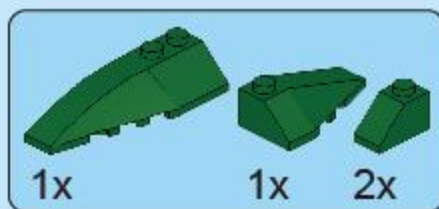
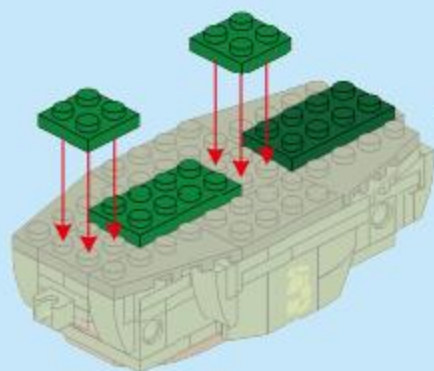

A23

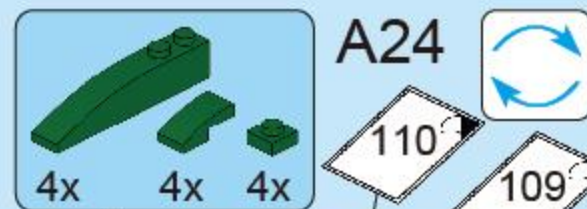
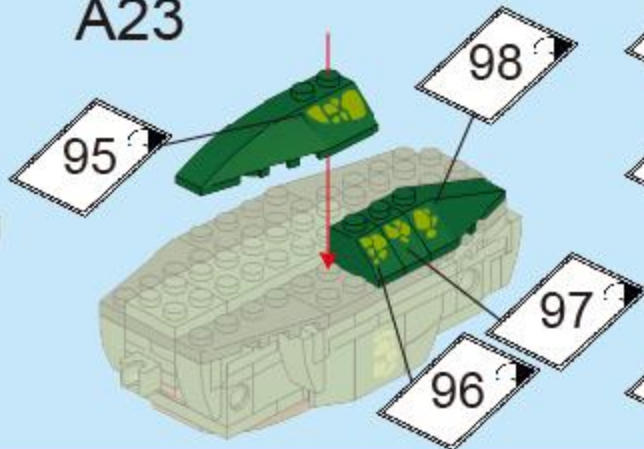

A24

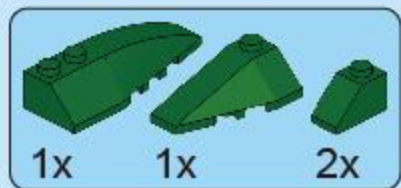
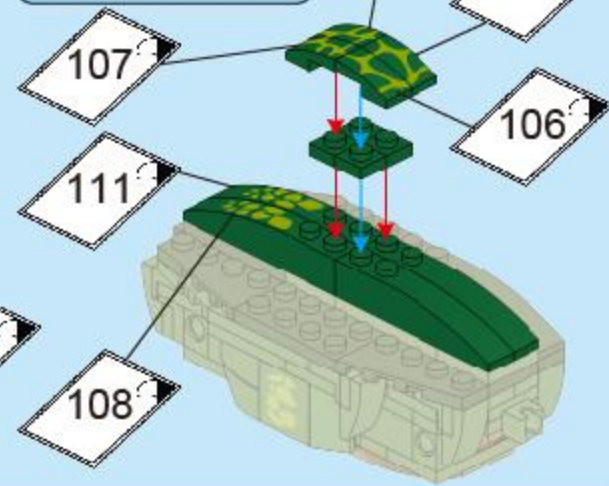

A25

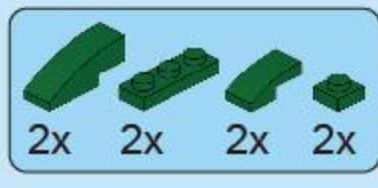
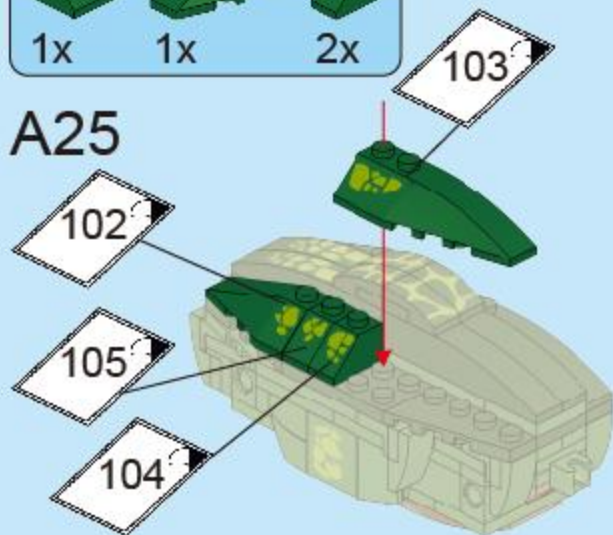

A26

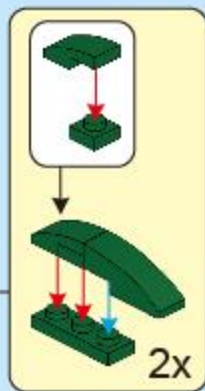
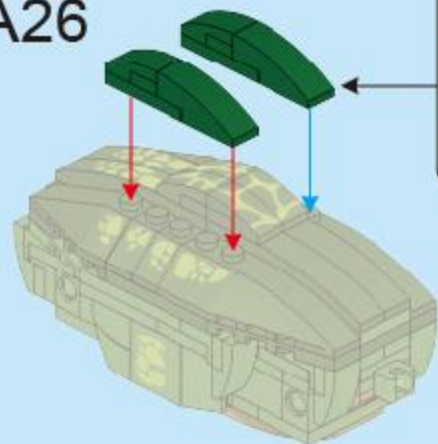

A27

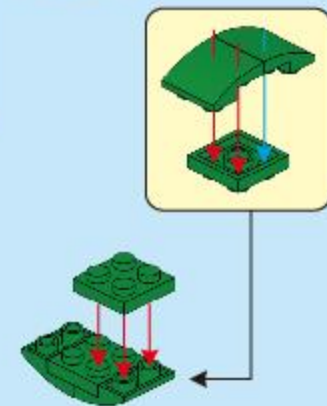

A28

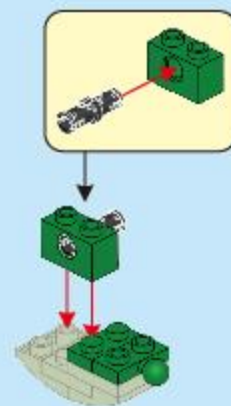



A29

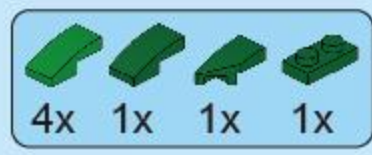

A30

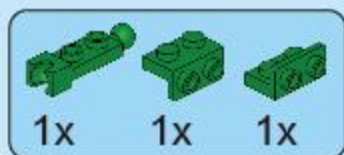

A31

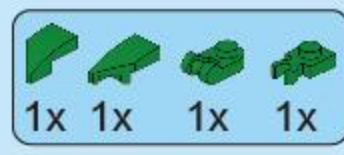

A32

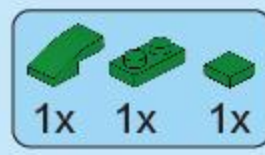

A33

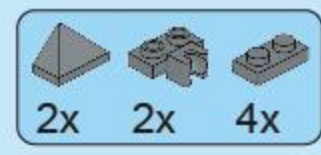

A34

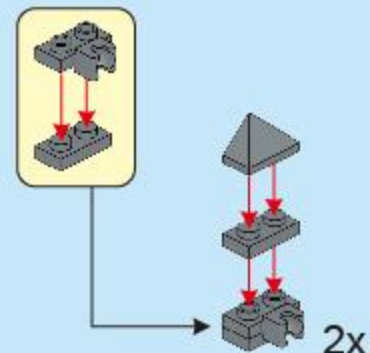
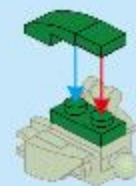
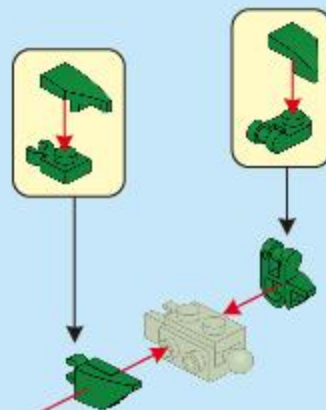
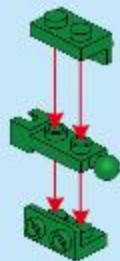
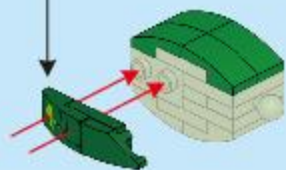
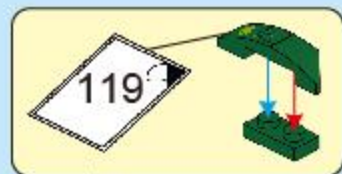
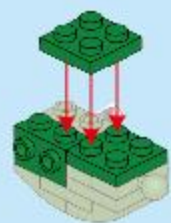

A35

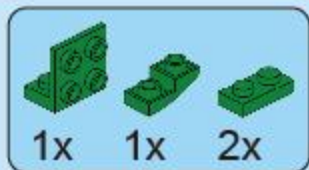

A36



A37

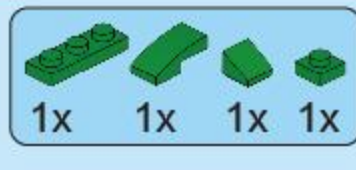

A38



A39

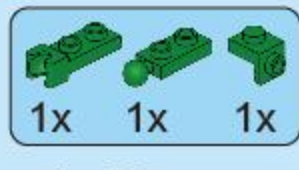

A40



A30



A33



A34

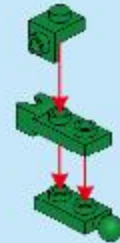
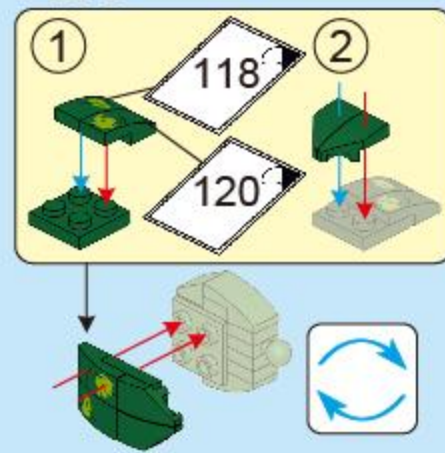
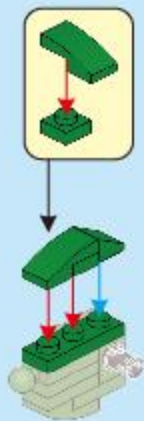
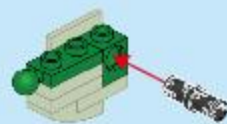
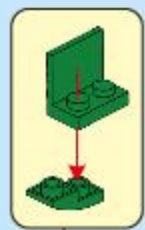
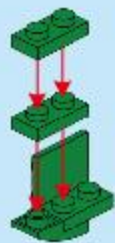

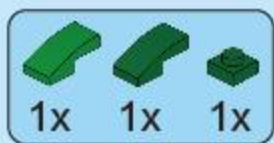

A41

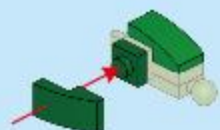

A42

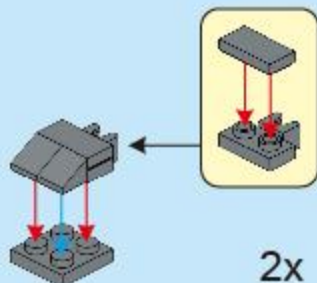

2x

A43

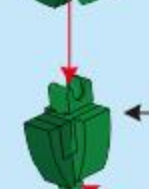

A39

A41

A42

A44

A26

A35

A43

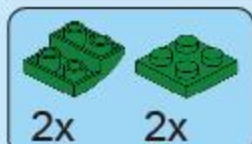
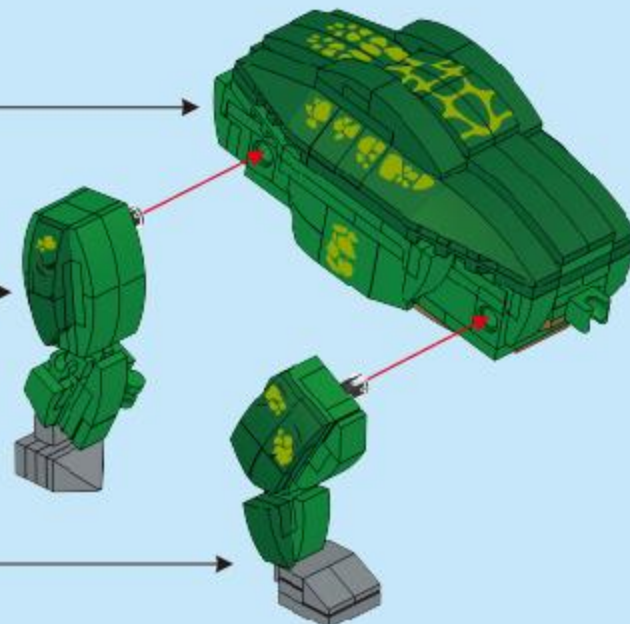

A45

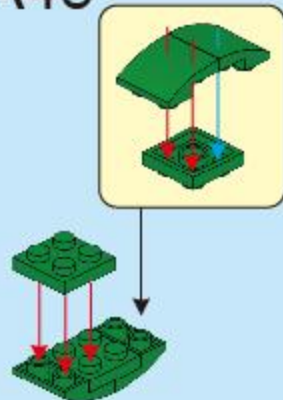

A46

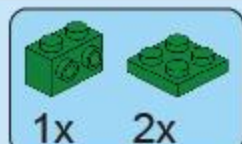
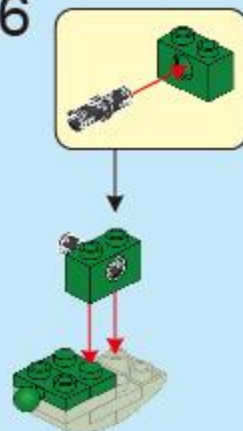

A47

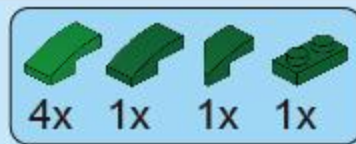

A48

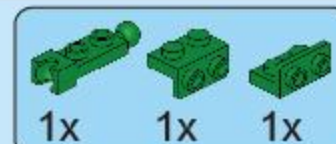
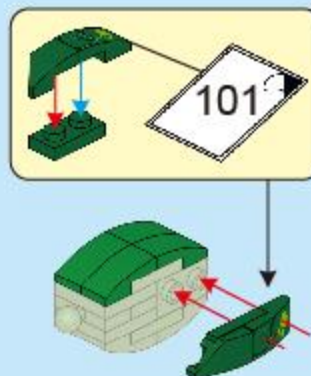

A49

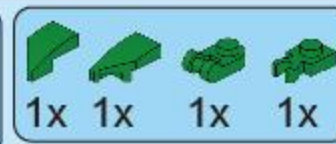
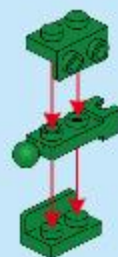

A50

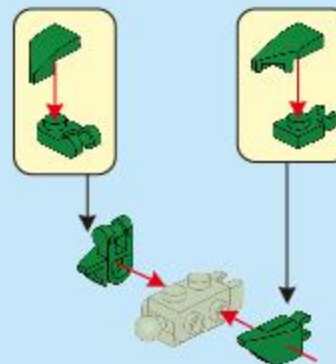

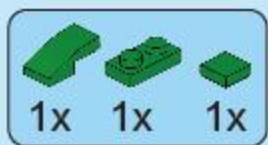

A51

A52

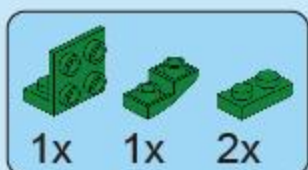

A53



A54

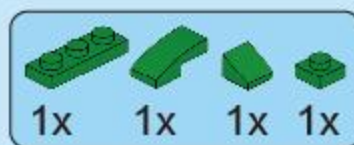

A55



A56

A48



A51

A34

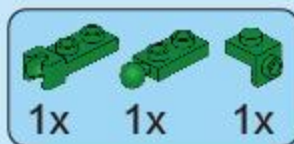
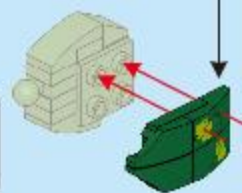
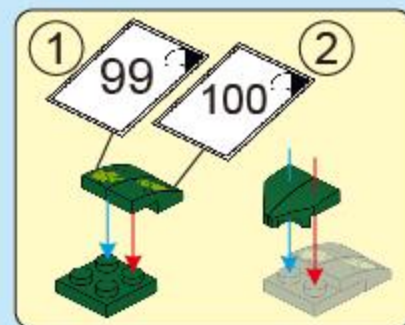
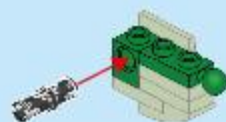
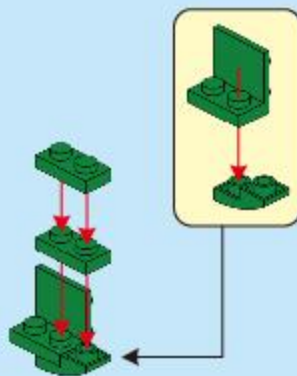
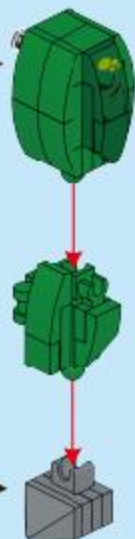
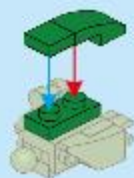

A57

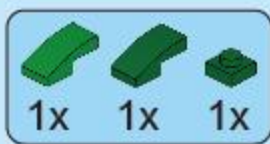

A58

A59



A56

A58

A42

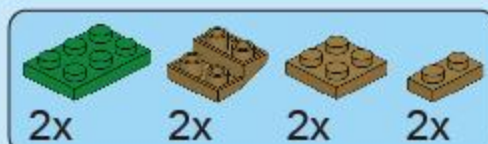
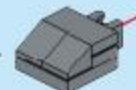
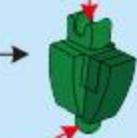

A60



A61

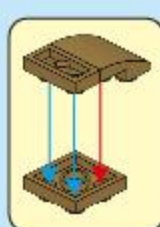

2x



2x





A62

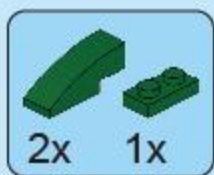
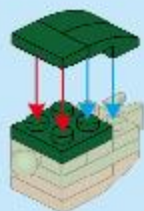

A63

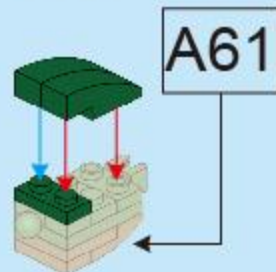

A64

A63

A62

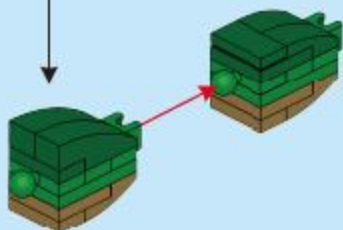

A65

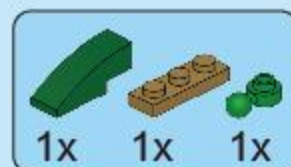
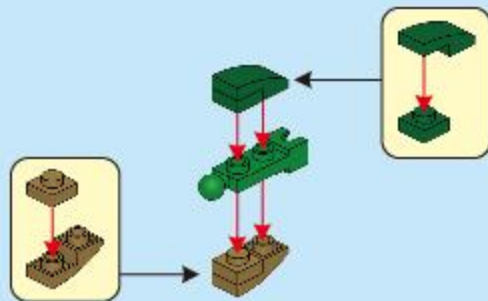

A66

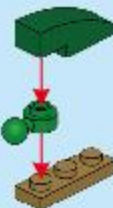

A67

A64

A65

A66

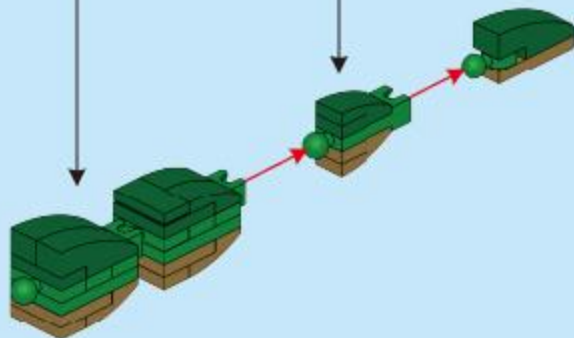

A68

A44

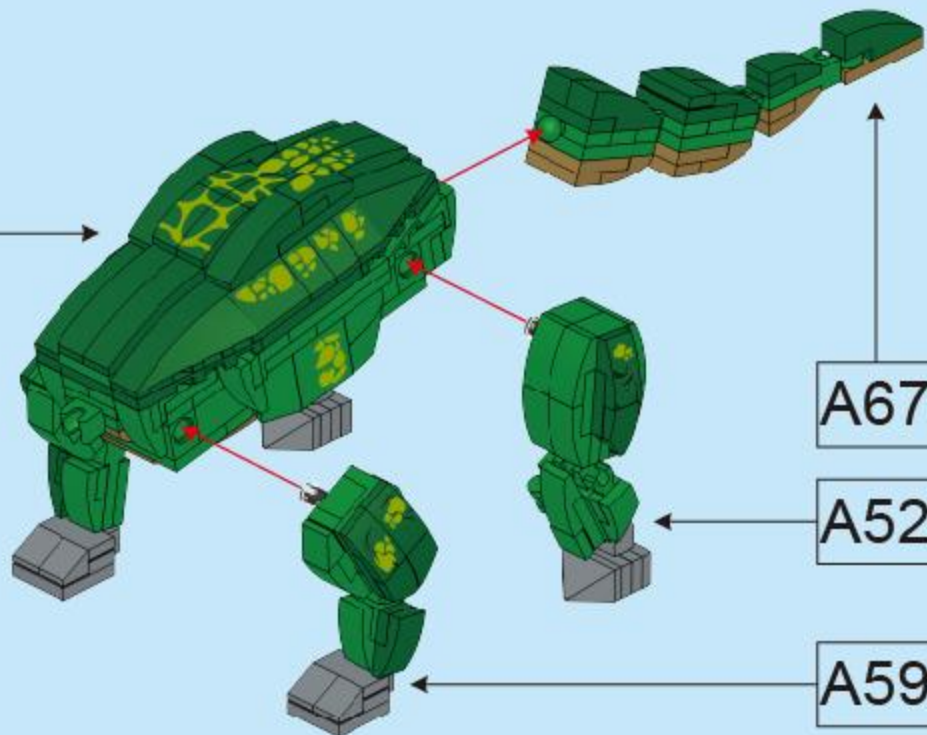

A67

A52

A59



A69

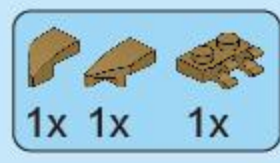

A70

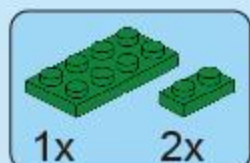

A71

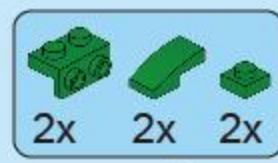

A72

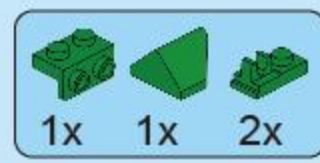

A73

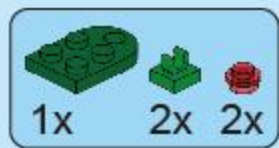
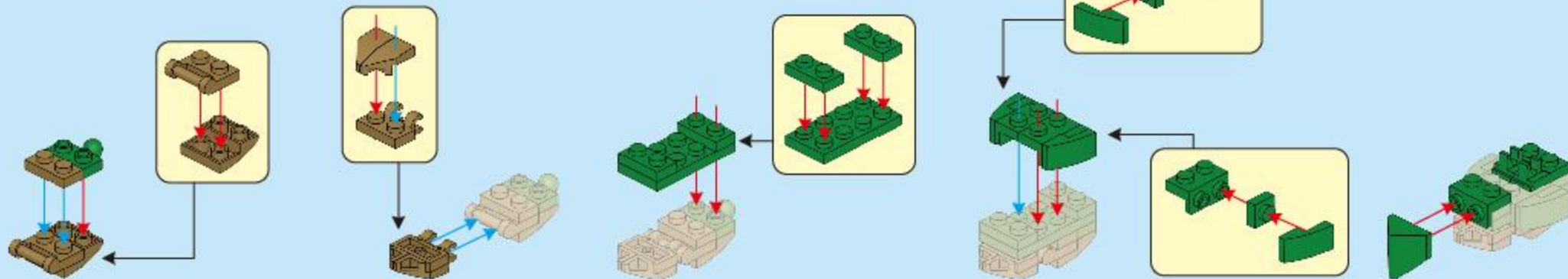

A74

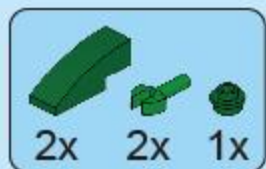

A75

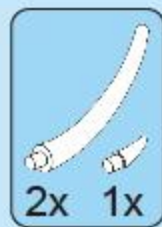

A76

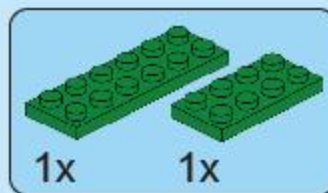

A77

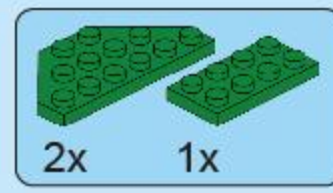

A78



A79

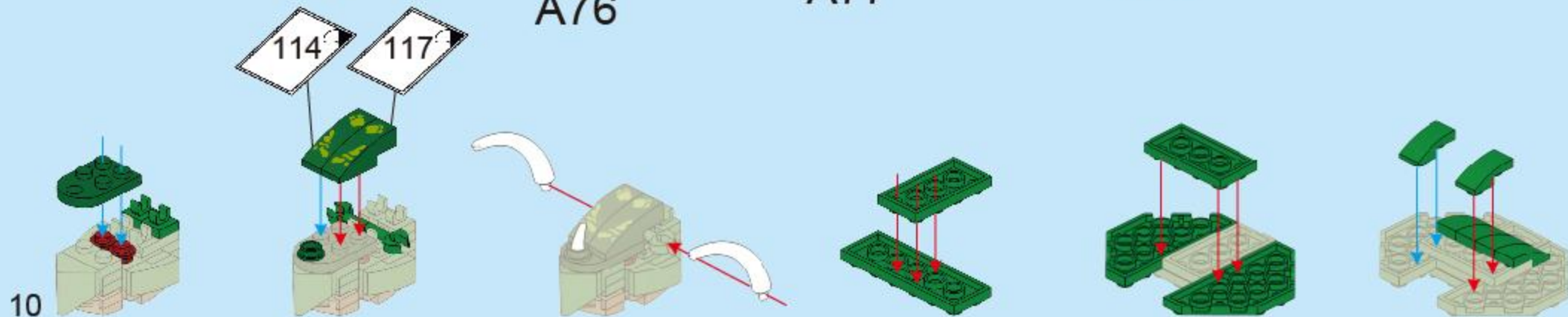

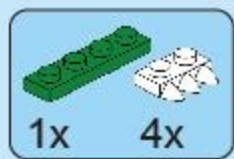

A80

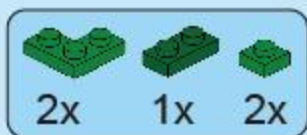
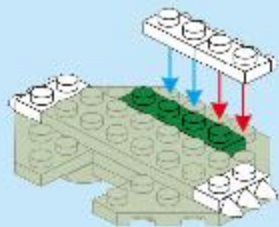

A81

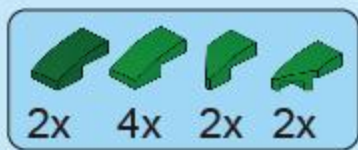

A82

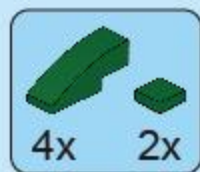
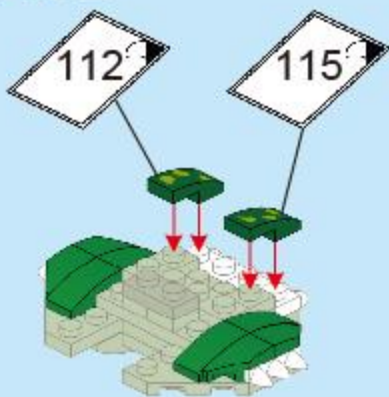

A83

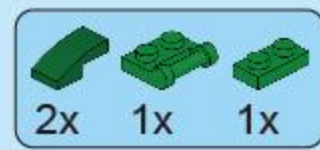
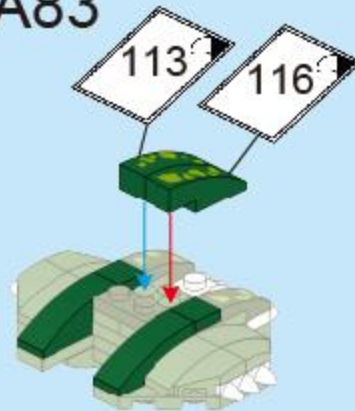

A84

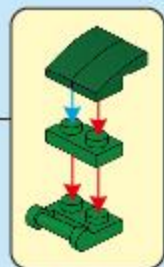
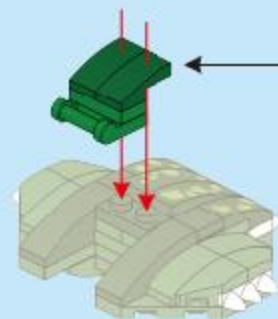

A85

A84



A76

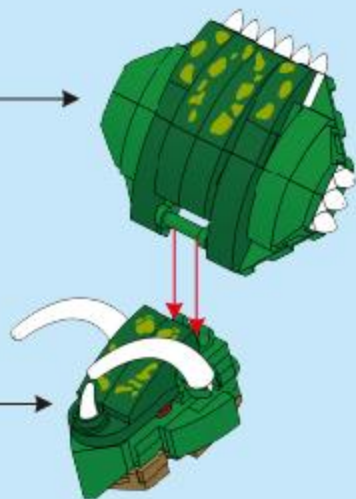

A86

A85

A68

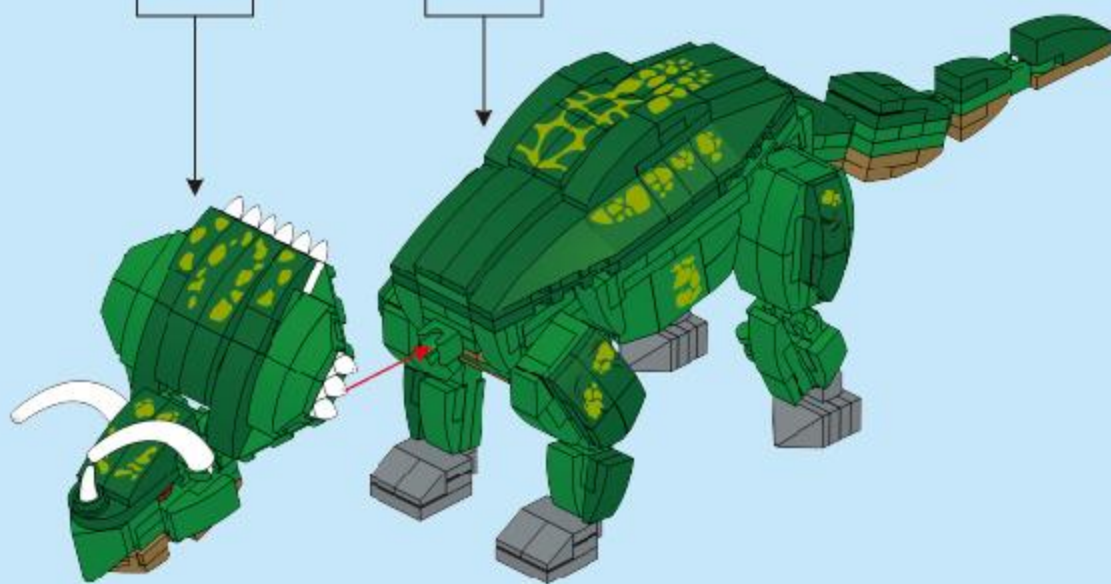

A

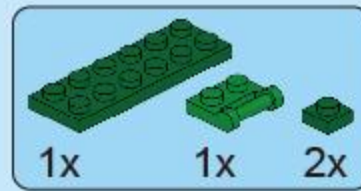
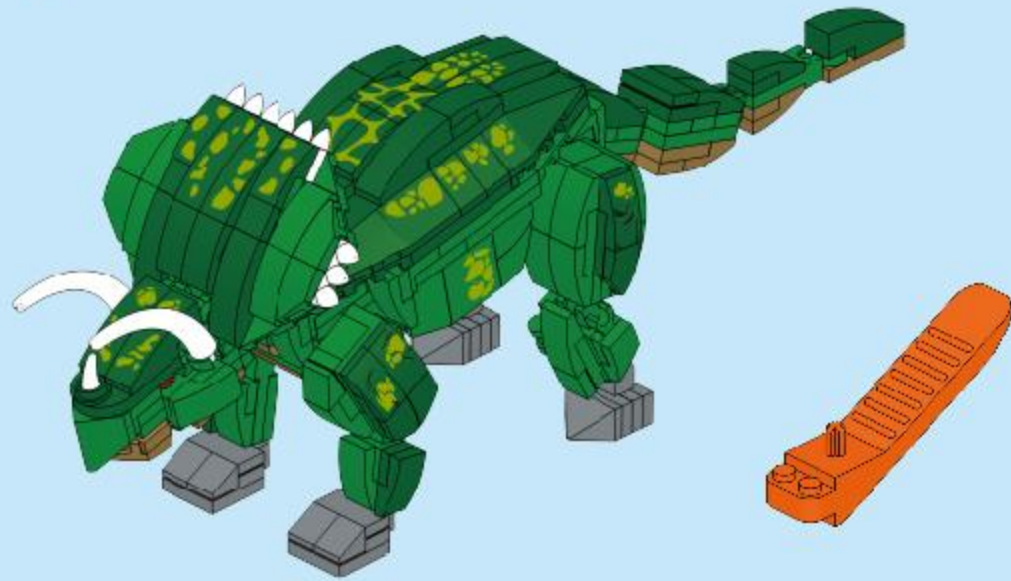

B1

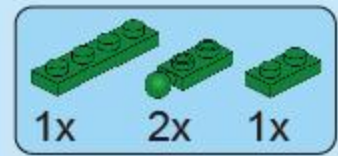
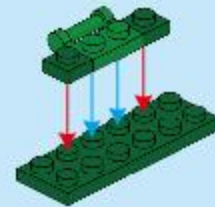

B2

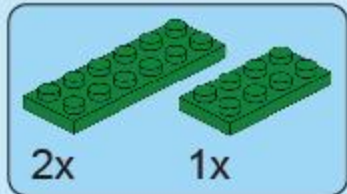
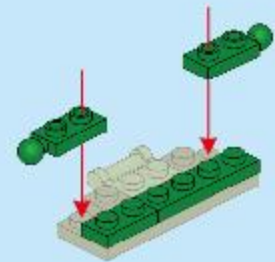

B3

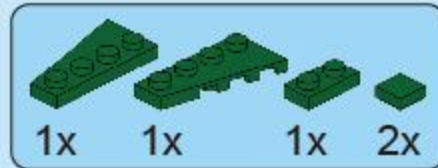
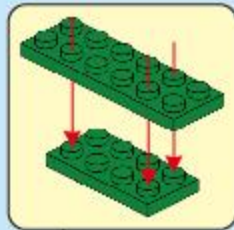
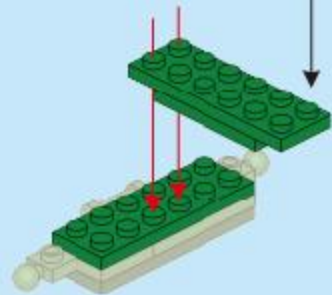

B4

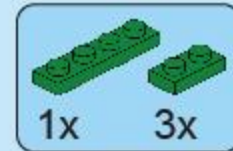
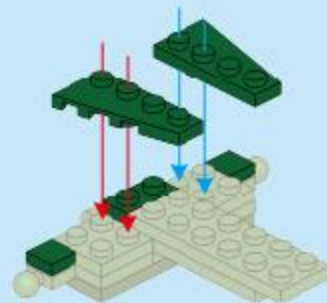

B5

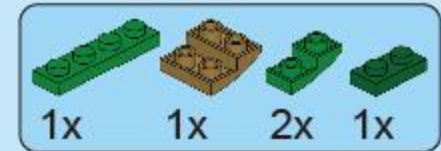
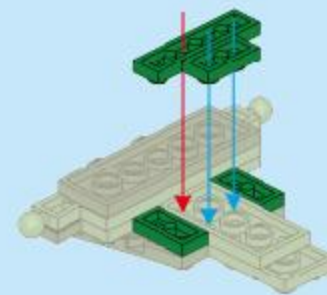

B6

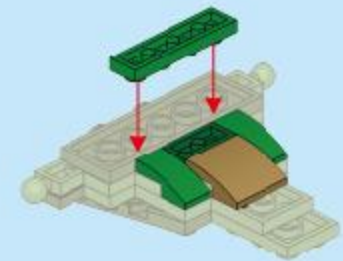



B7

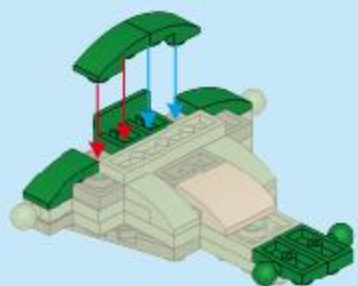

B8

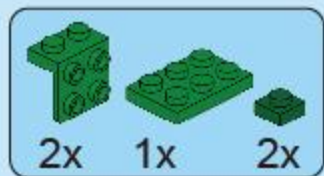
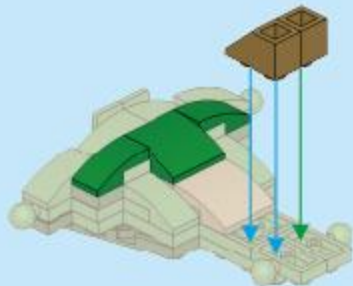

B9

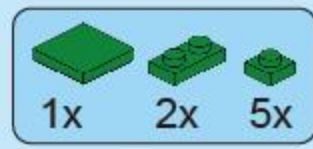
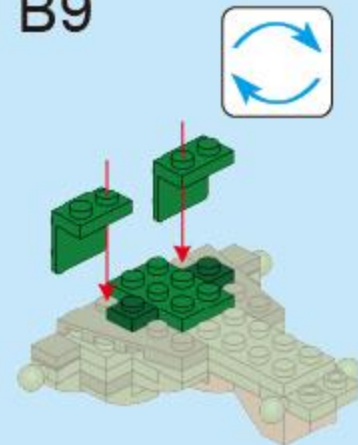

B10

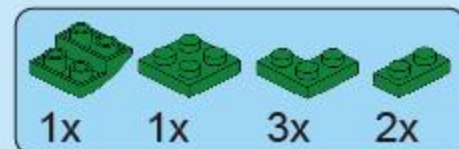
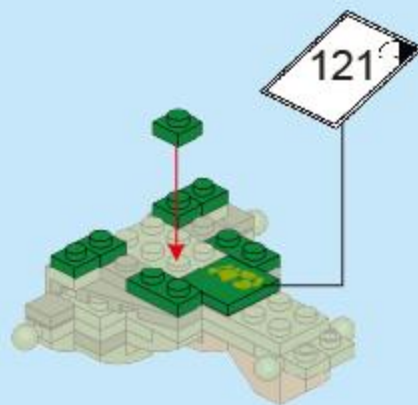

B11

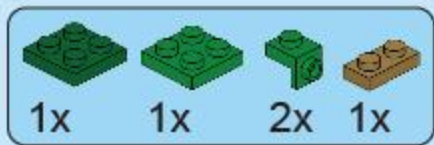
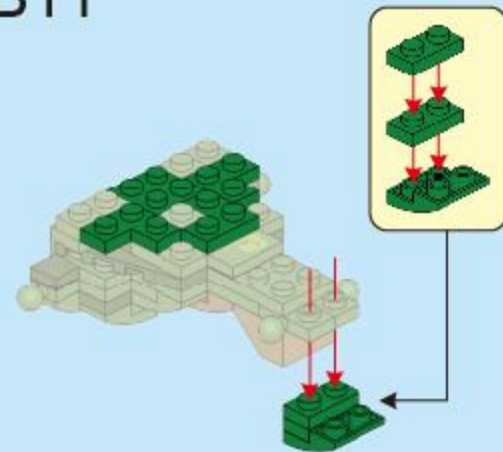

B12

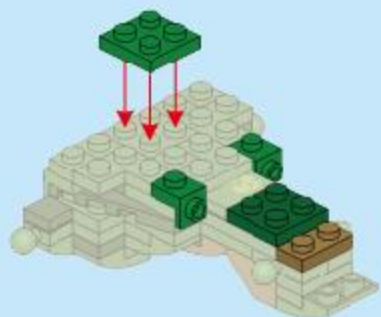

B13



B14

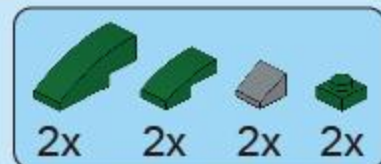
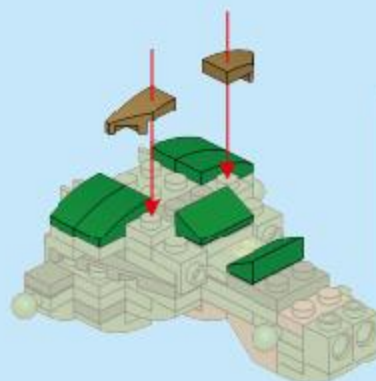

B15

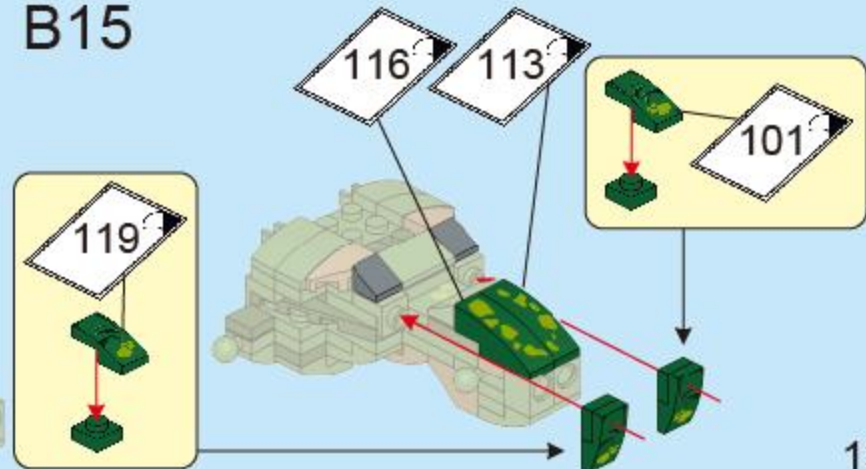

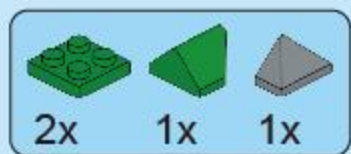

B16

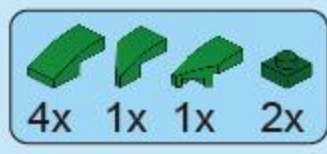
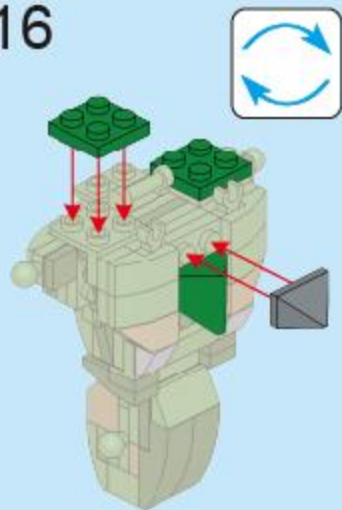

B17

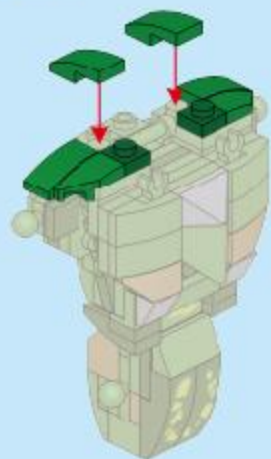

B18

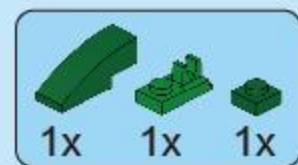
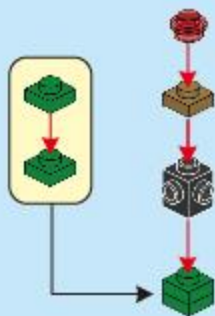

B19

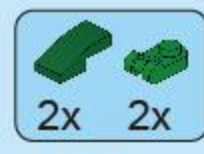
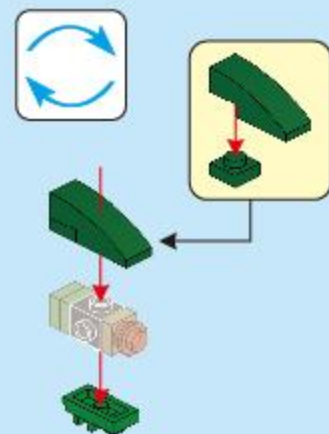

B20

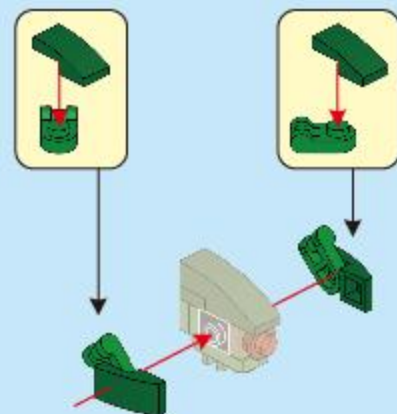

B21

B20

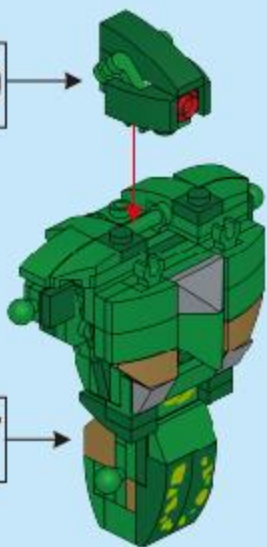

B17

14



B22

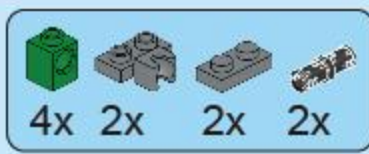
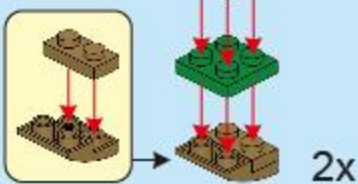

B23

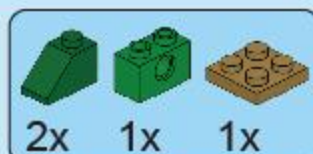
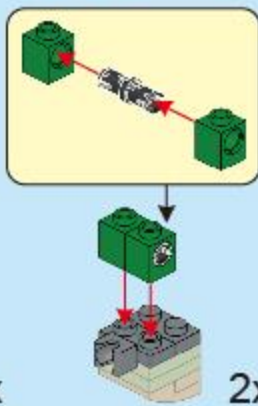

B24

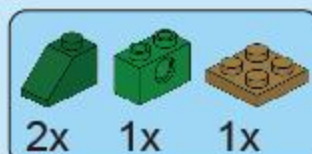
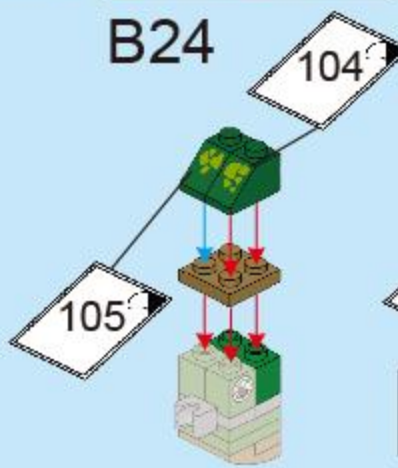

B25

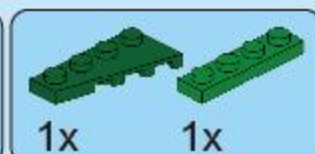
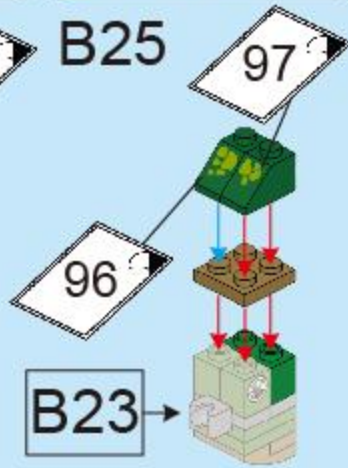

B26

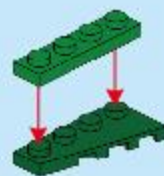

B23

104

97

105

96



B27

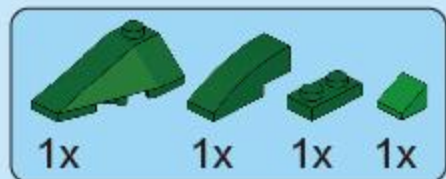
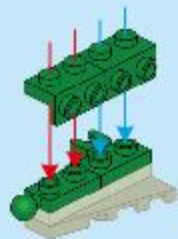

B28

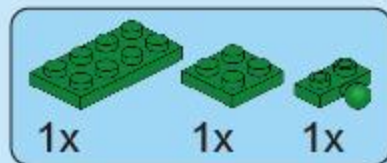
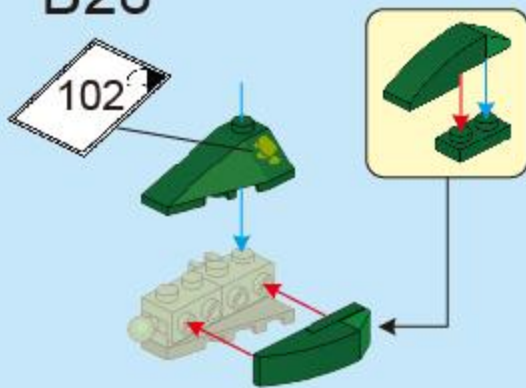

B29

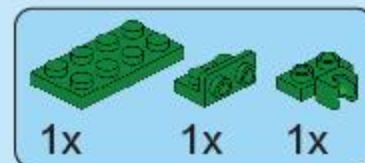

B30

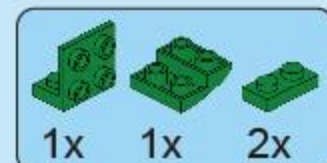

B31

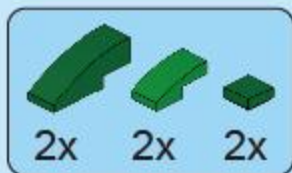
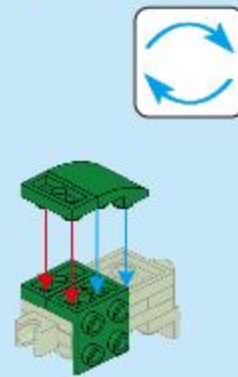

B32

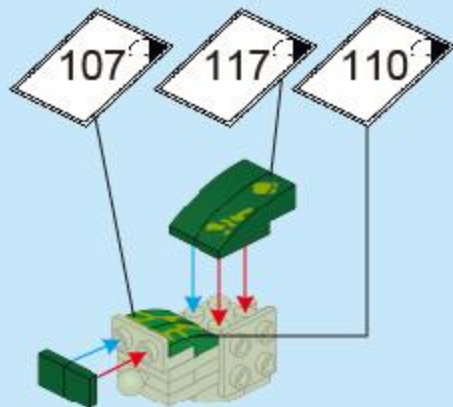

B33

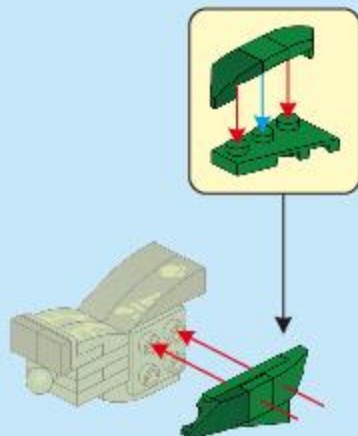

B34

B28

B33

B33

B25

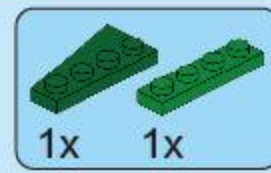
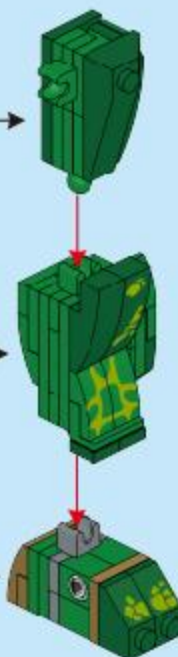

B35

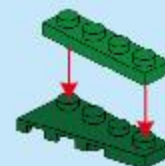

B36

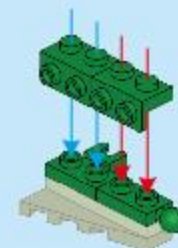

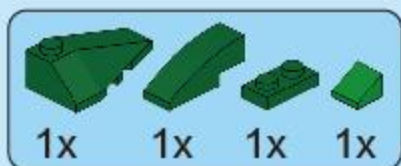

B37

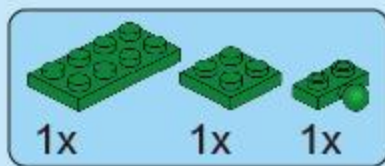
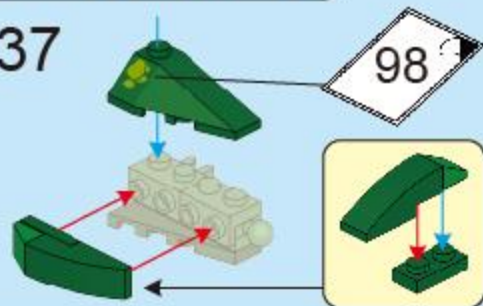

B38

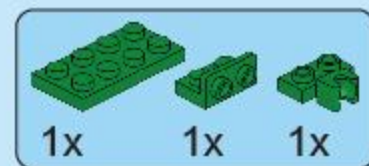

B39

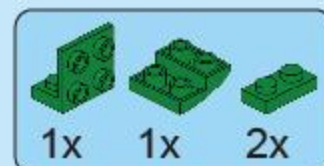
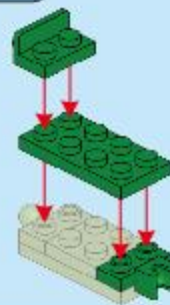

B40

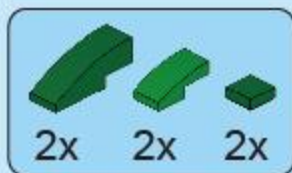
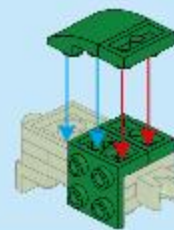

B41

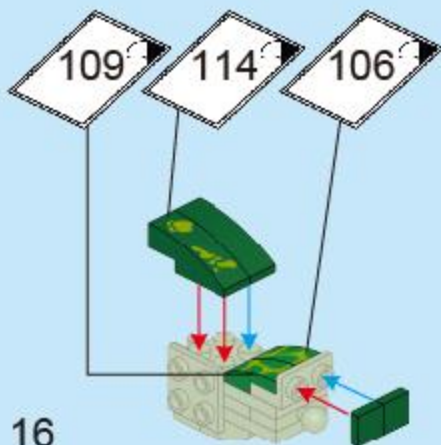

16

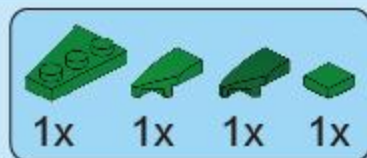

B42

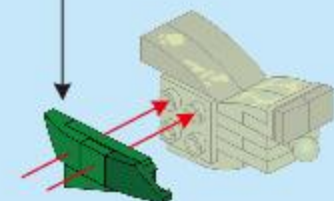

B43



B37



B42



B24



B44

B21

B43

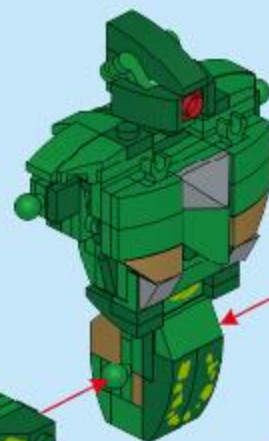

B34





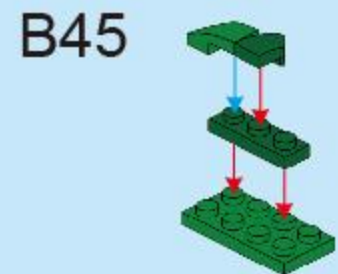
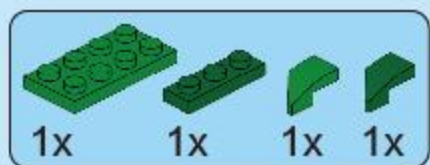

B45

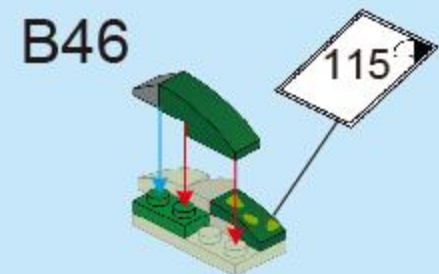
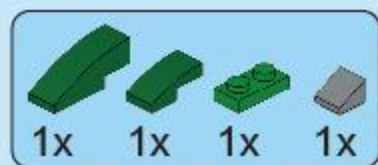

B46

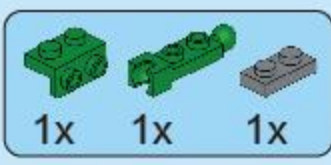

B47

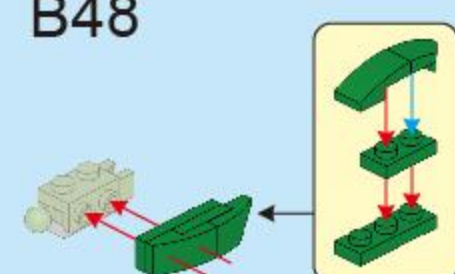
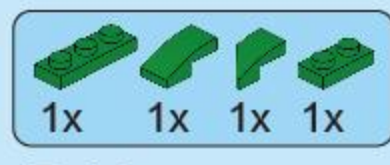

B48

B49 

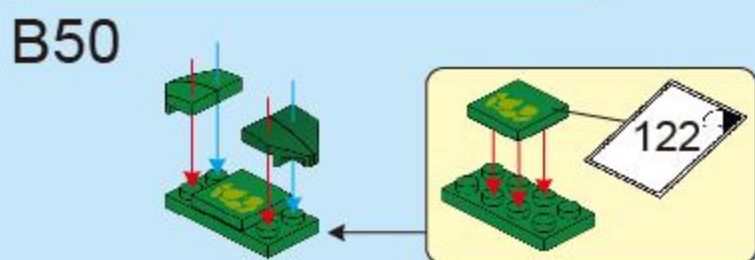
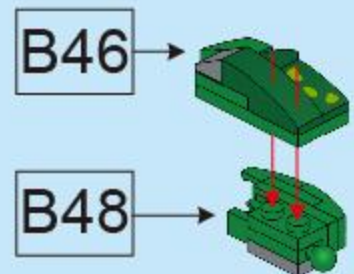

B50

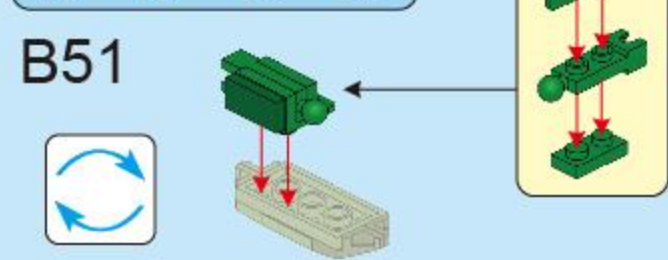
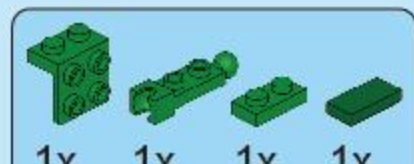

B51

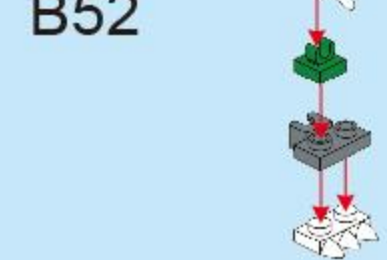

B52

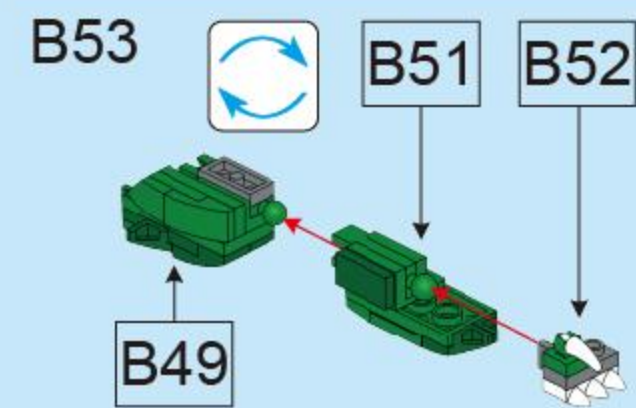

B53

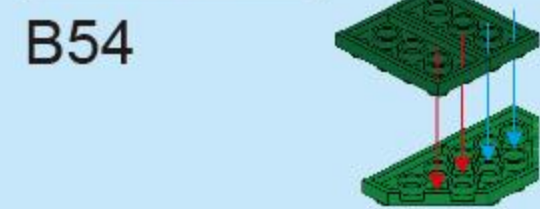
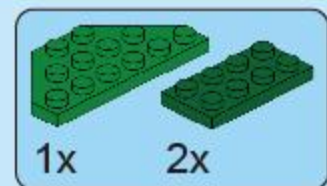

B54

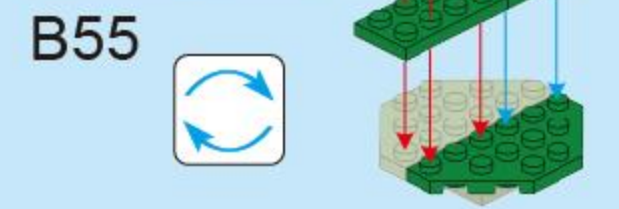
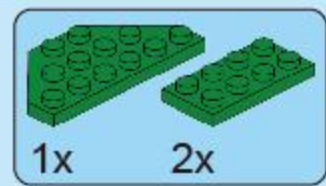

B55

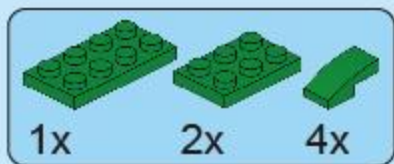

1x 2x 4x

B56

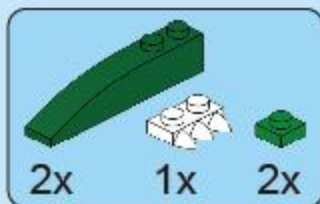
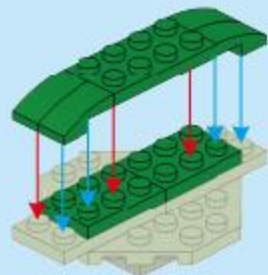

2x 1x 2x

B57

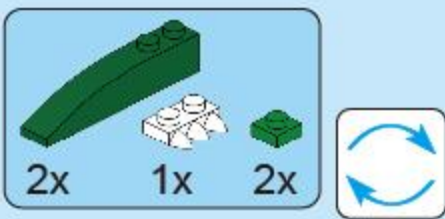
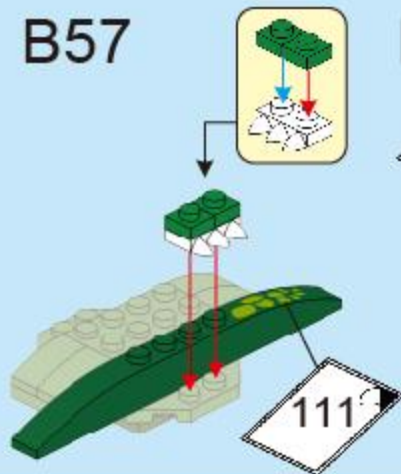

2x 1x 2x

B58

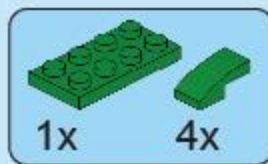
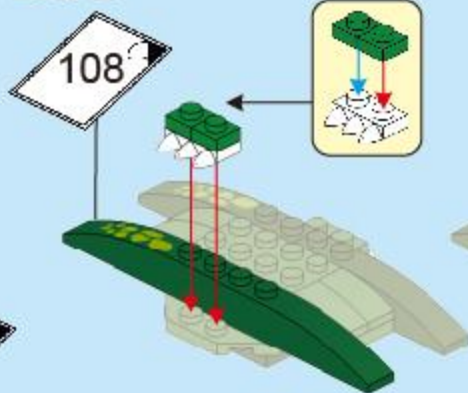

1x 4x

B59

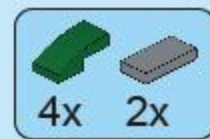
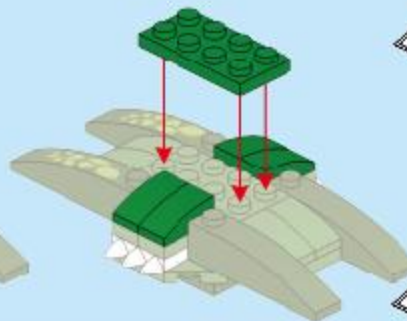

4x 2x

B60

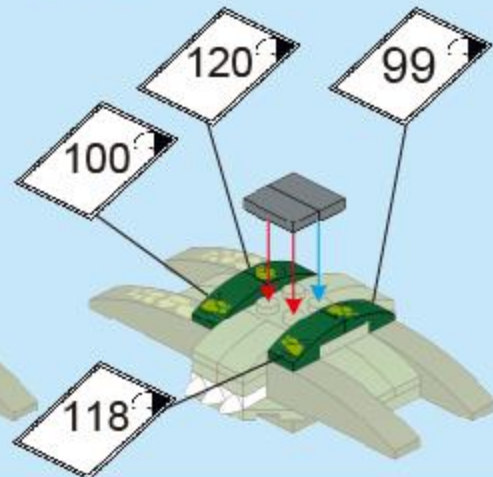

1x 1x 1x 1x

B61

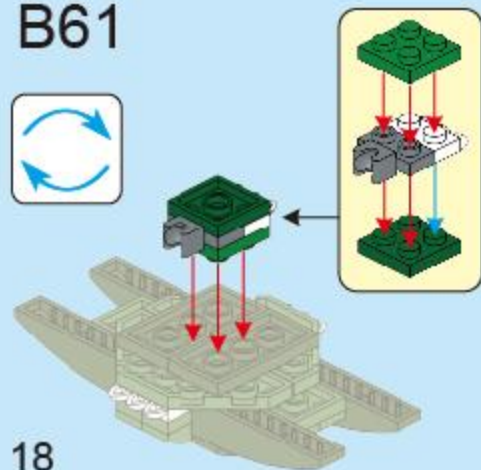

18

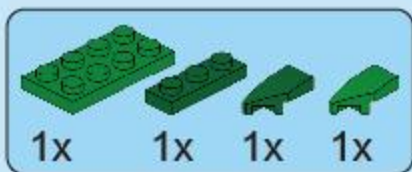

1x 1x 1x 1x

B62

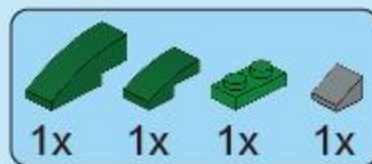
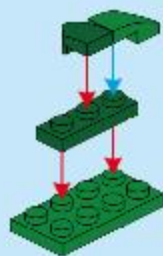

1x 1x 1x 1x

B63

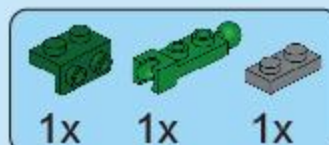
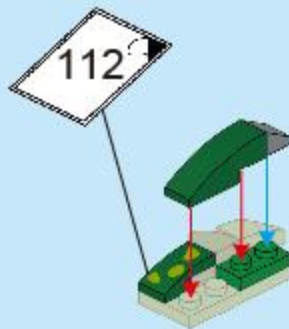

1x 1x 1x

B64

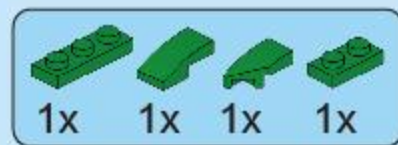
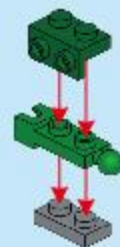

1x 1x 1x 1x

B65

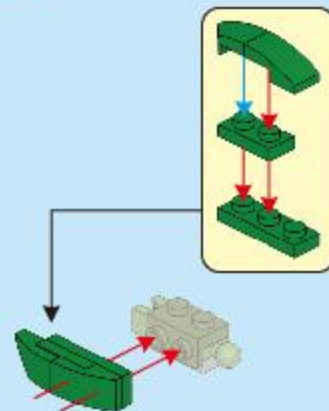

B66 

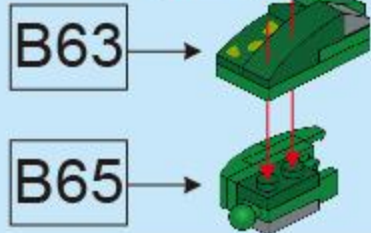

  
1x 1x 1x

B67

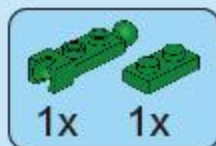

  
1x 1x

B68

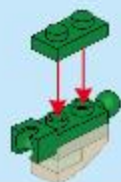

B69



B66



B68

B61

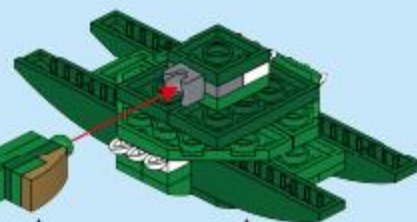

B70



B53

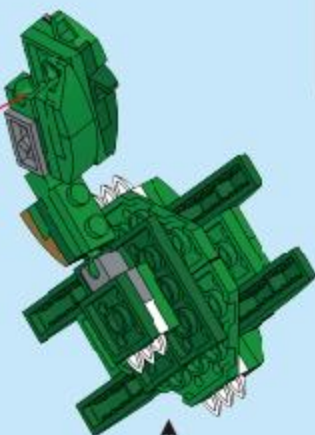
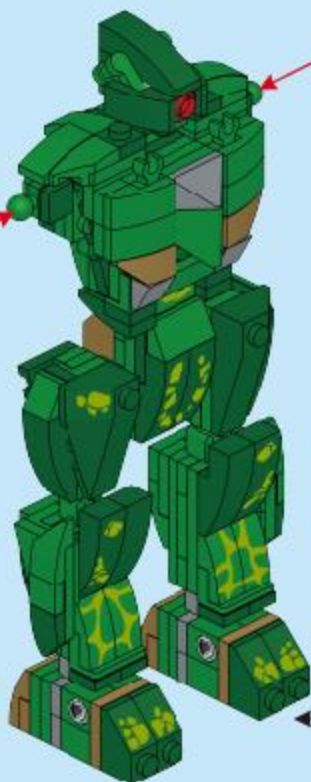

B69

B44

  
2x

B71

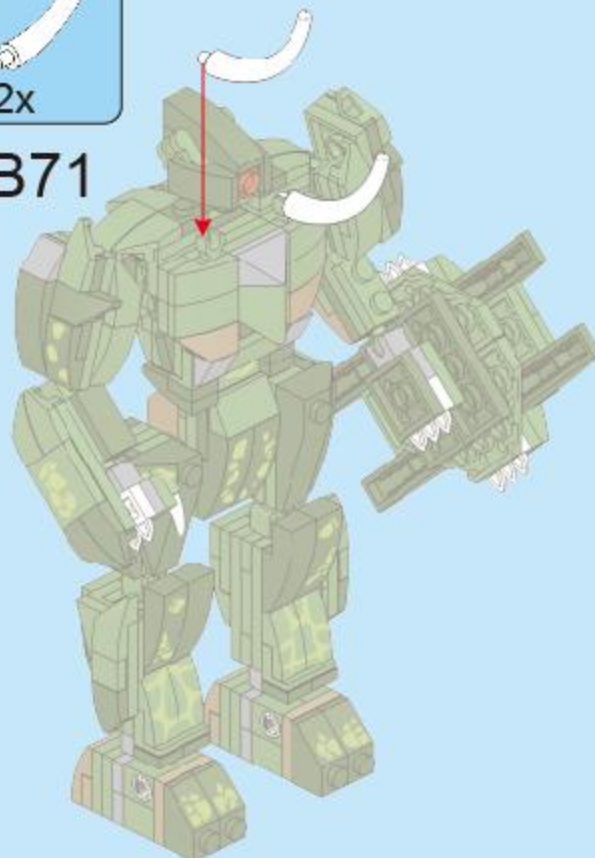

B



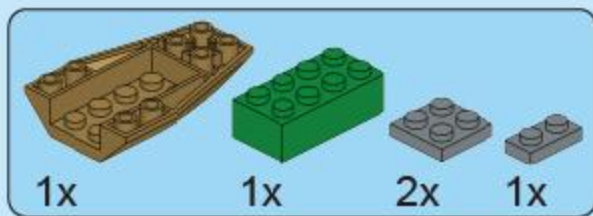

C1

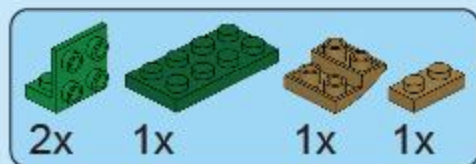

C2

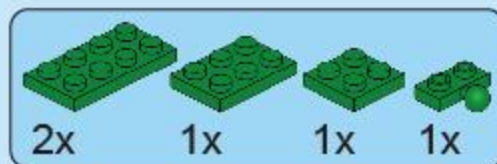

C3

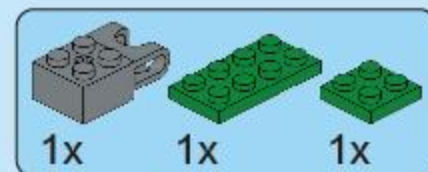

C4

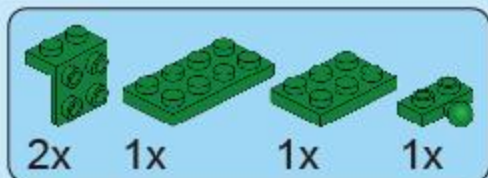
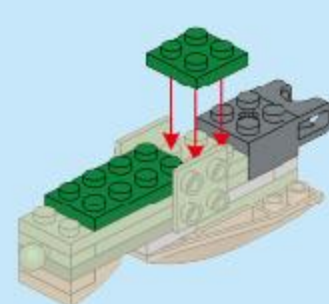
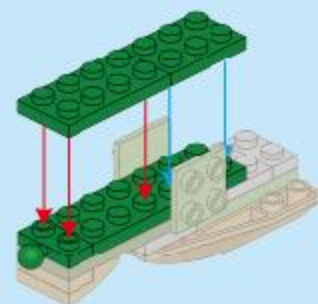
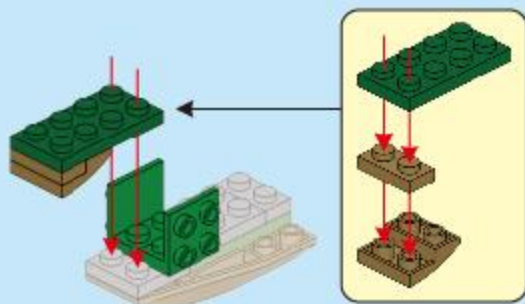
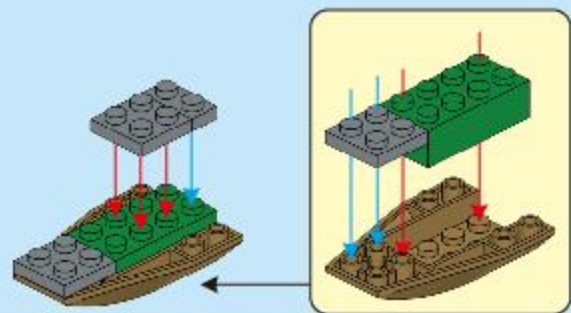

C5

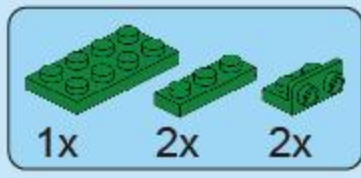

C6

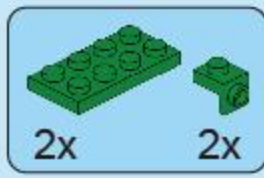

C7

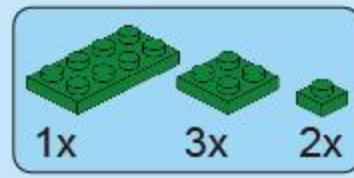

C8

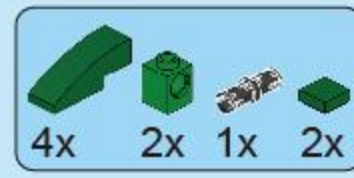

C9

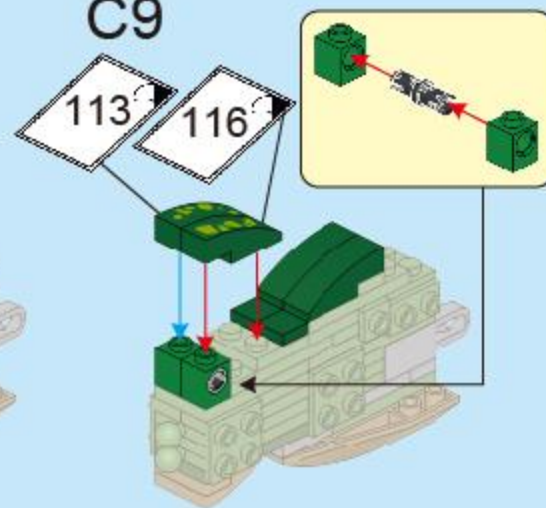
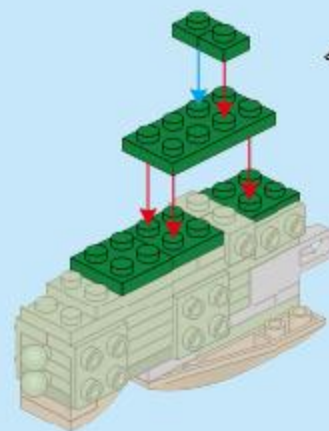
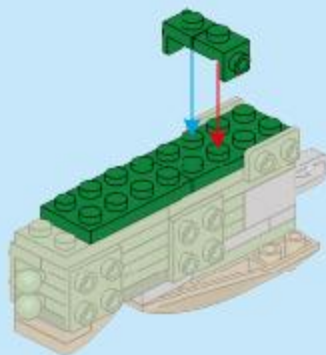
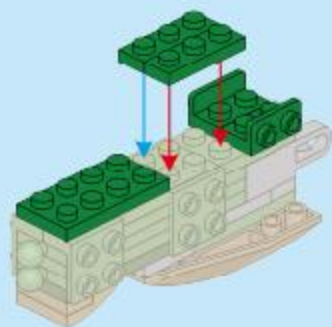
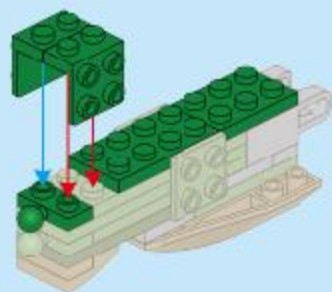

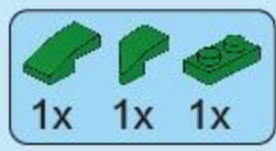

C10

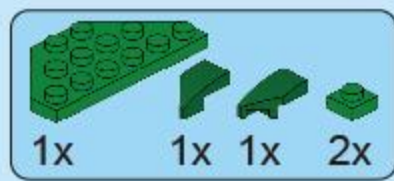
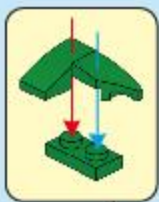

C11

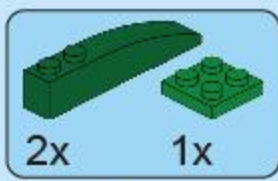
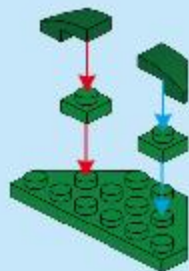

C12

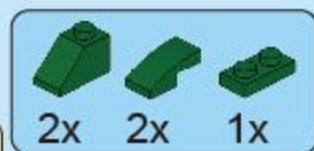
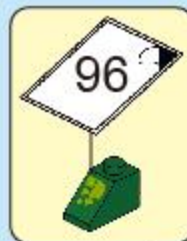
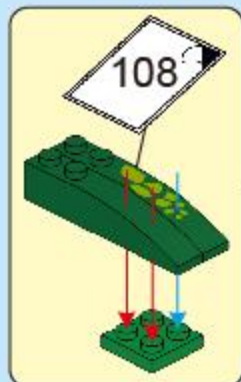

C13

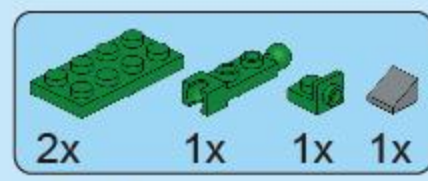
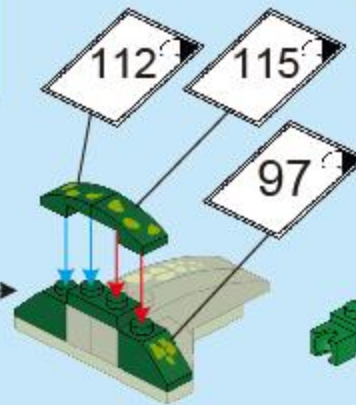

C14

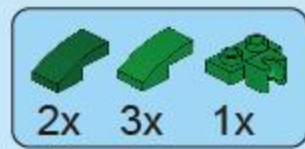
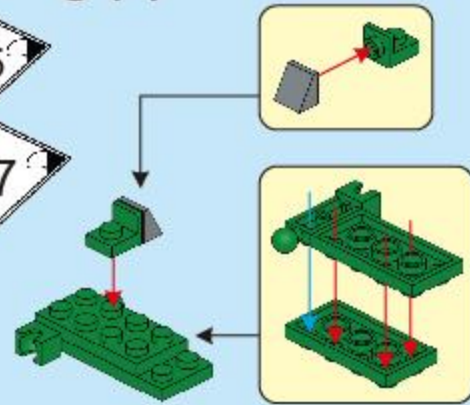

C15

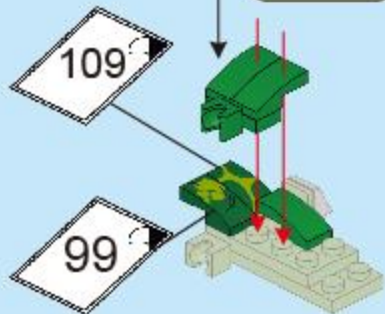
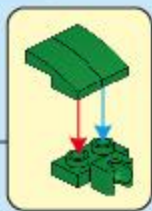

C16

C15

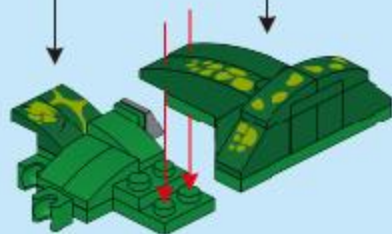

C17



C10

C16

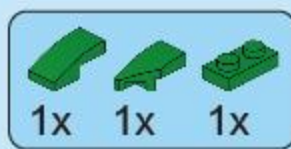
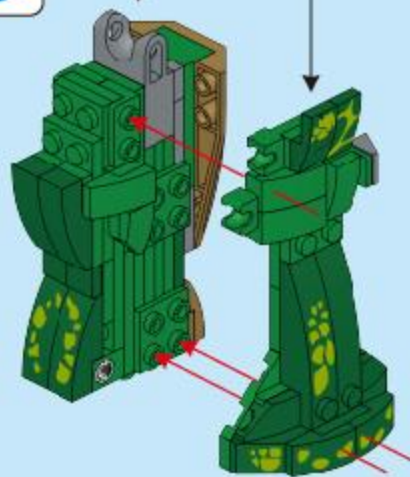

C18

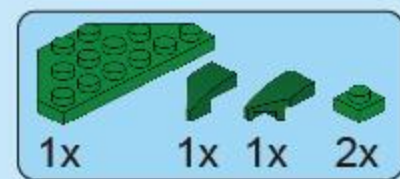
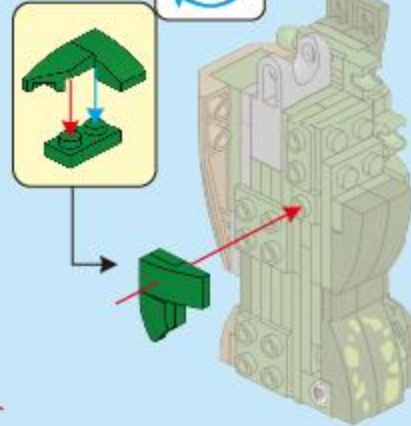

C19

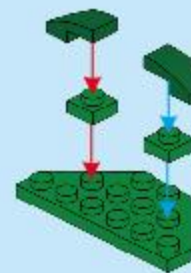

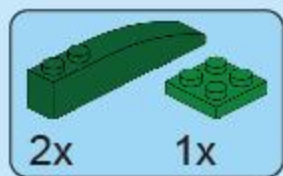

C20

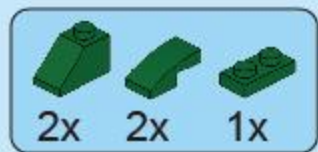
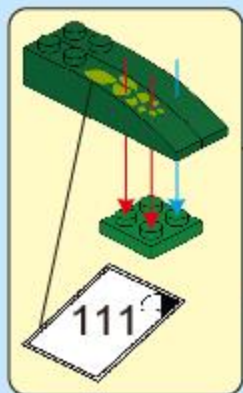

C21

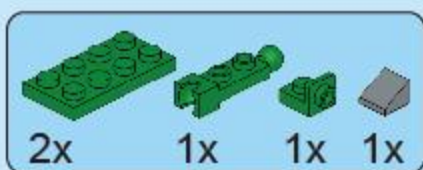
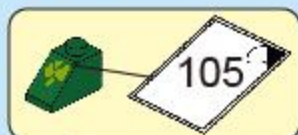

C22

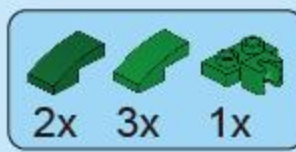
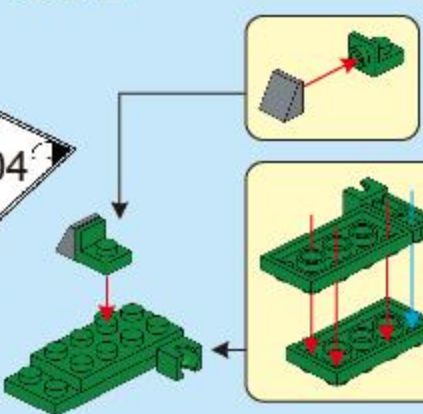

C23

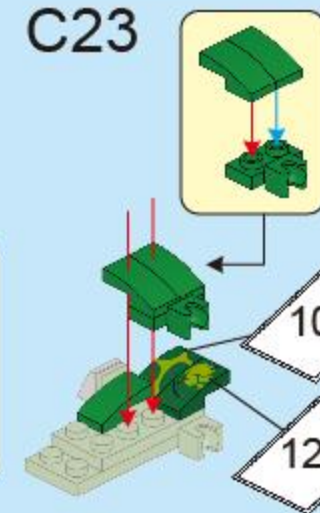

C24

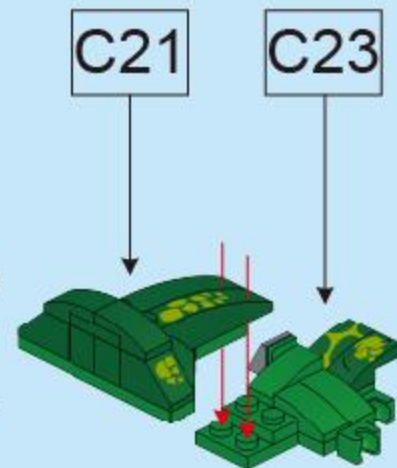

C25

C18



C24

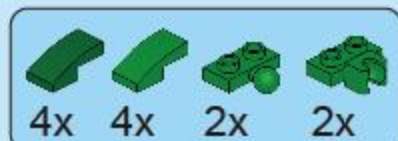
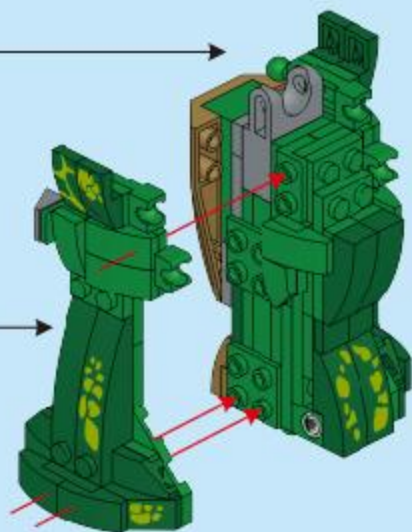

C26

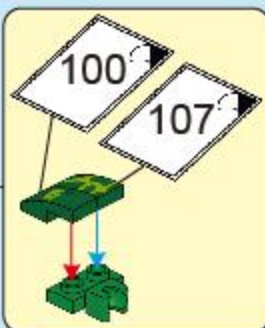
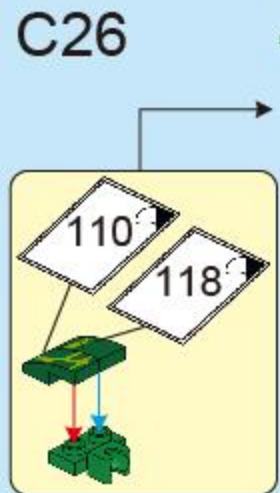

C27

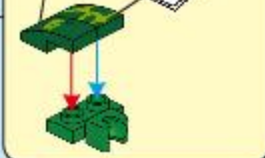

C28

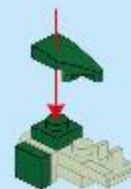
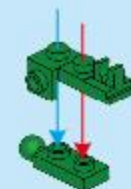
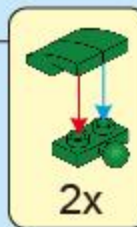

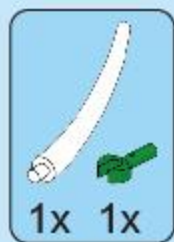

1x 1x

C29



1x 1x 1x

C30

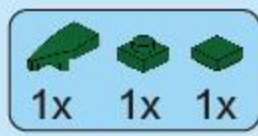

1x 1x 1x

C31

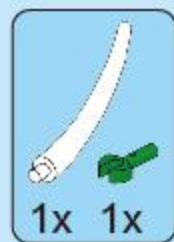

1x 1x

C32

C33



C26

C29

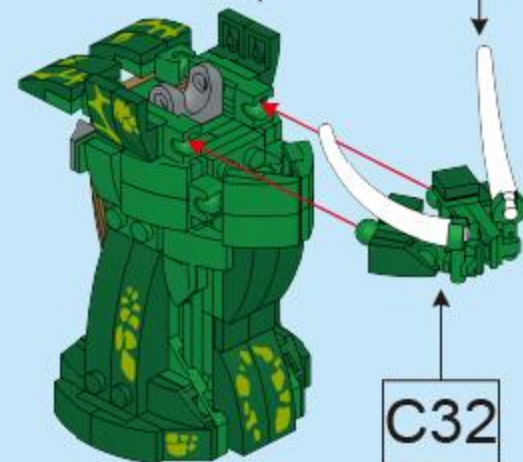

C32



1x 2x 2x 1x

C34

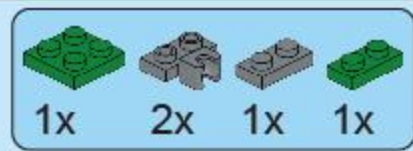

1x 2x 1x 1x

C35



1x 2x 4x 1x

C36

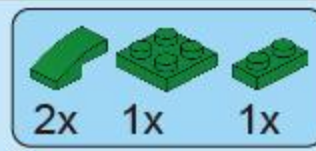

2x 1x 1x

C37

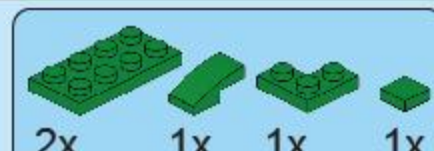

2x 1x 1x 1x

C38

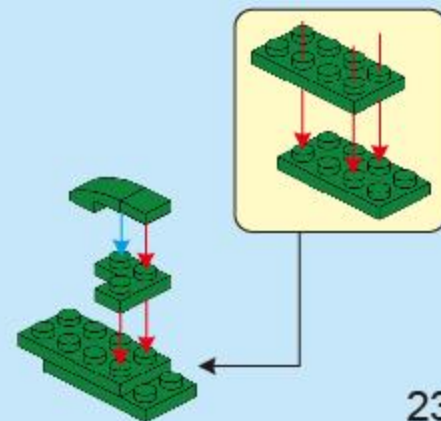
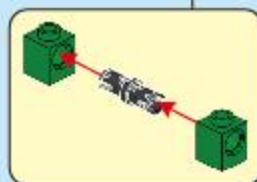
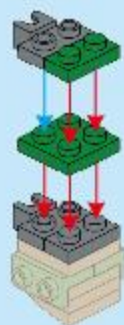
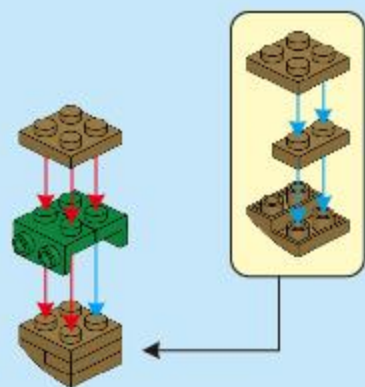

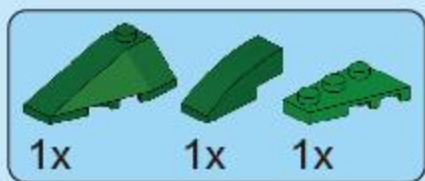

C39

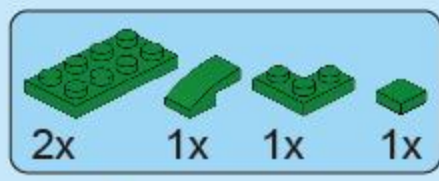
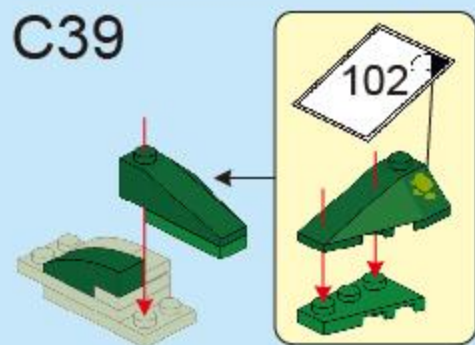

C40

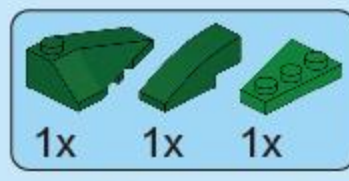
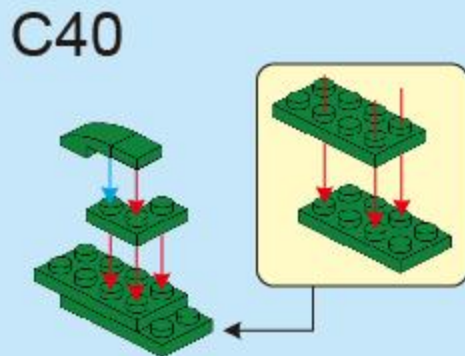

C41

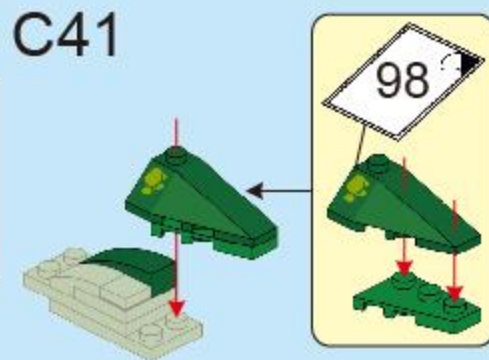

C42

C41



C39

C37

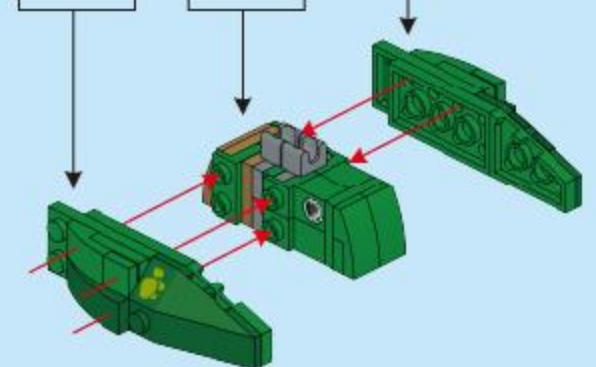

C43

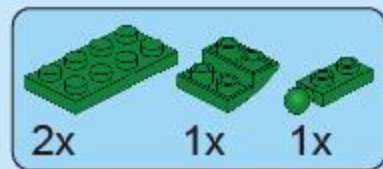
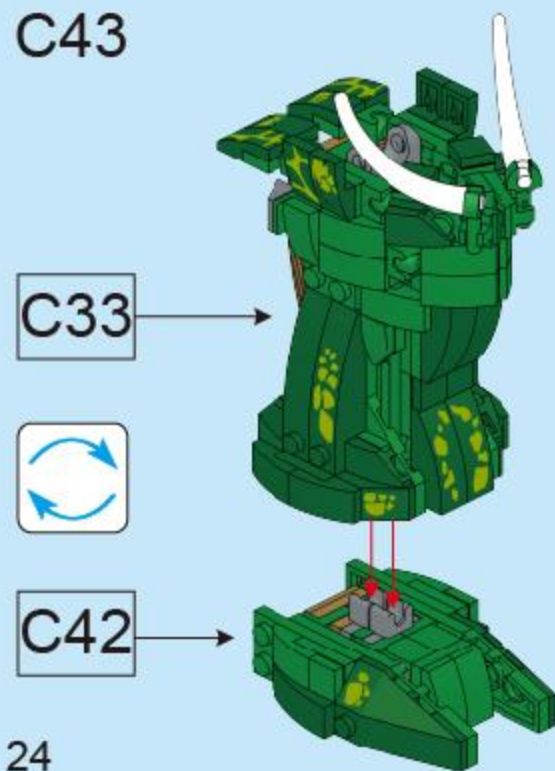

C44

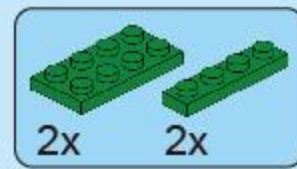
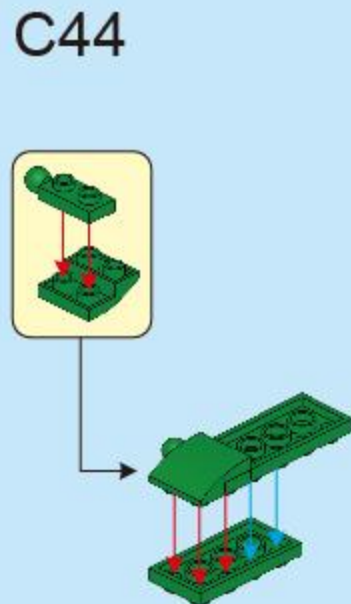

C45

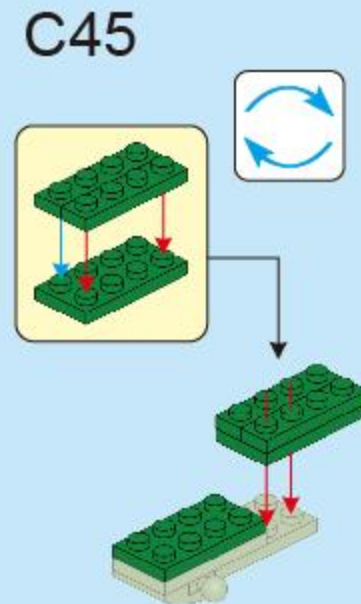

C46

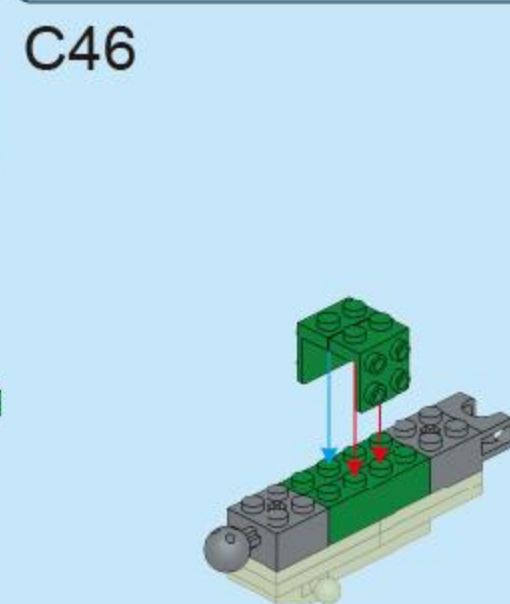



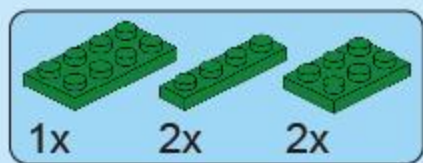

C47

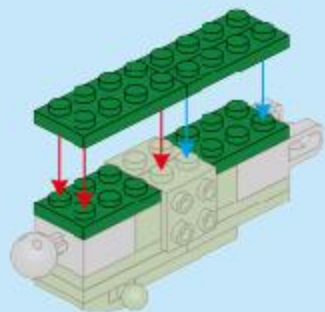

C48

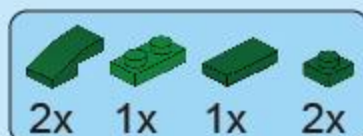
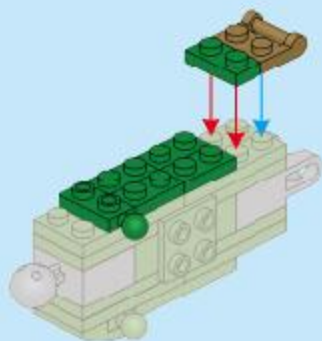

C49

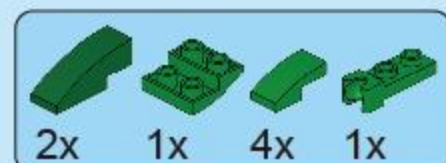
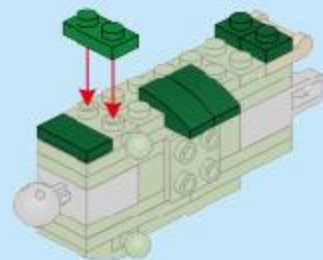

C50

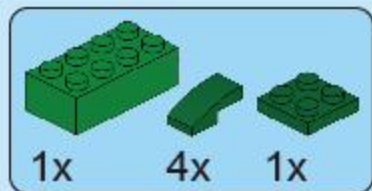
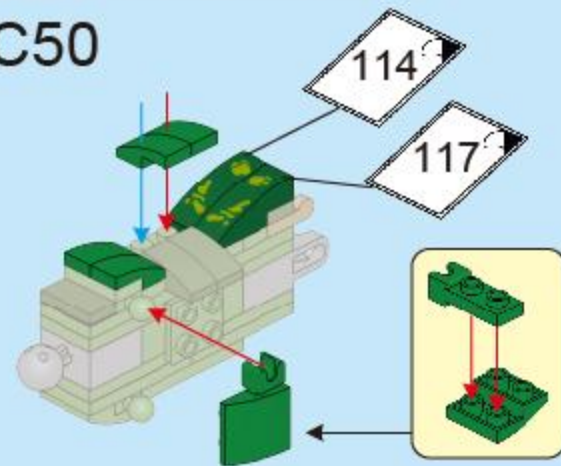

C51

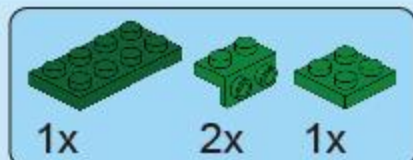
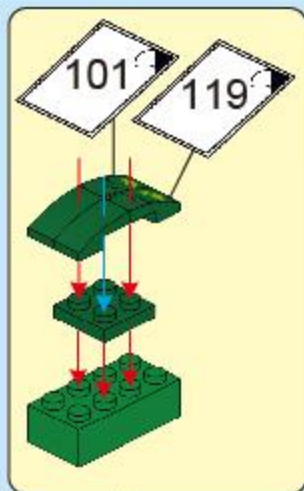
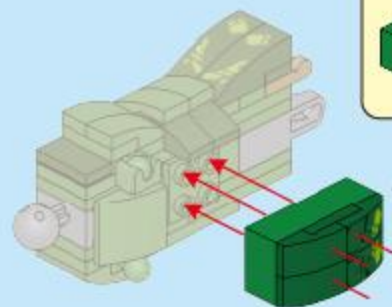

C52

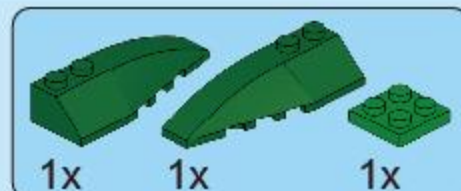
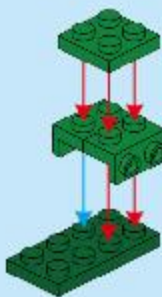

C53

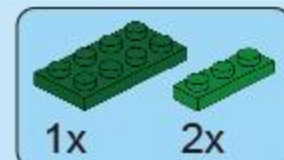
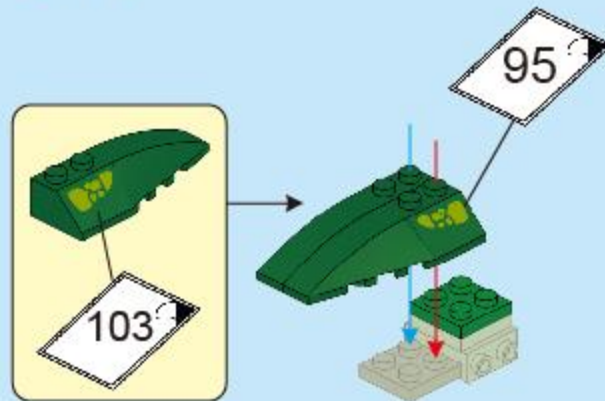

C54

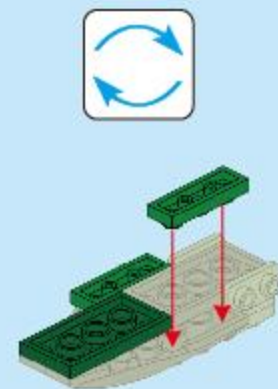



C56

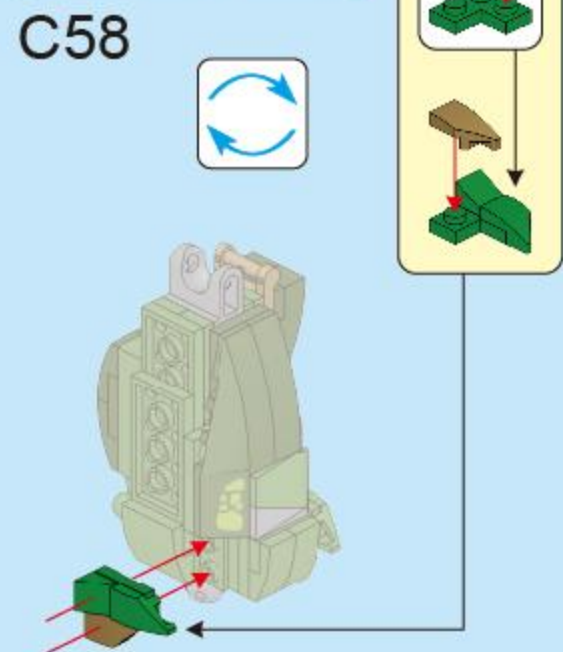
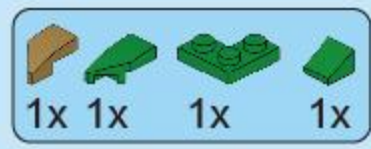
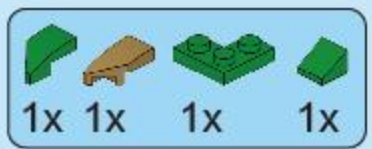
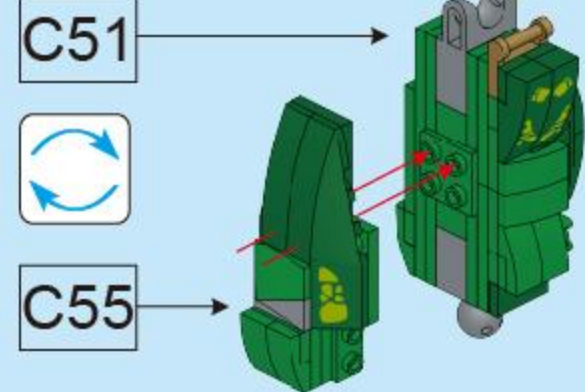

C59



C58

C43

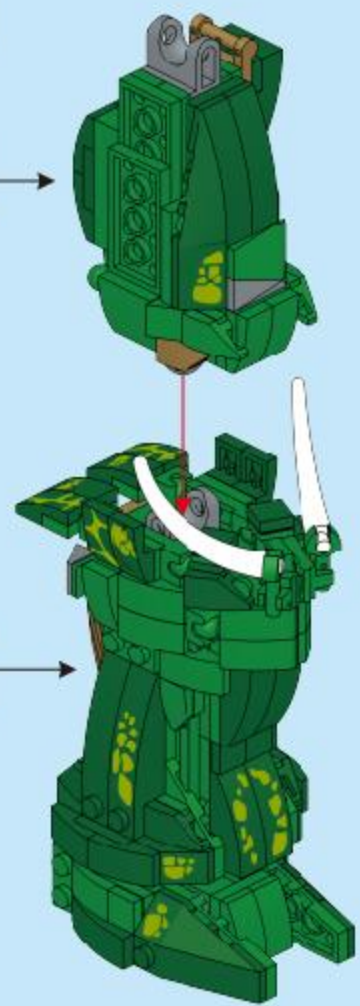

C



FC1021C

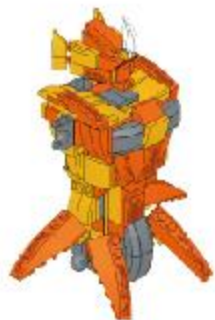

FC1022C



FC1024C



FC1023C



FC1025C

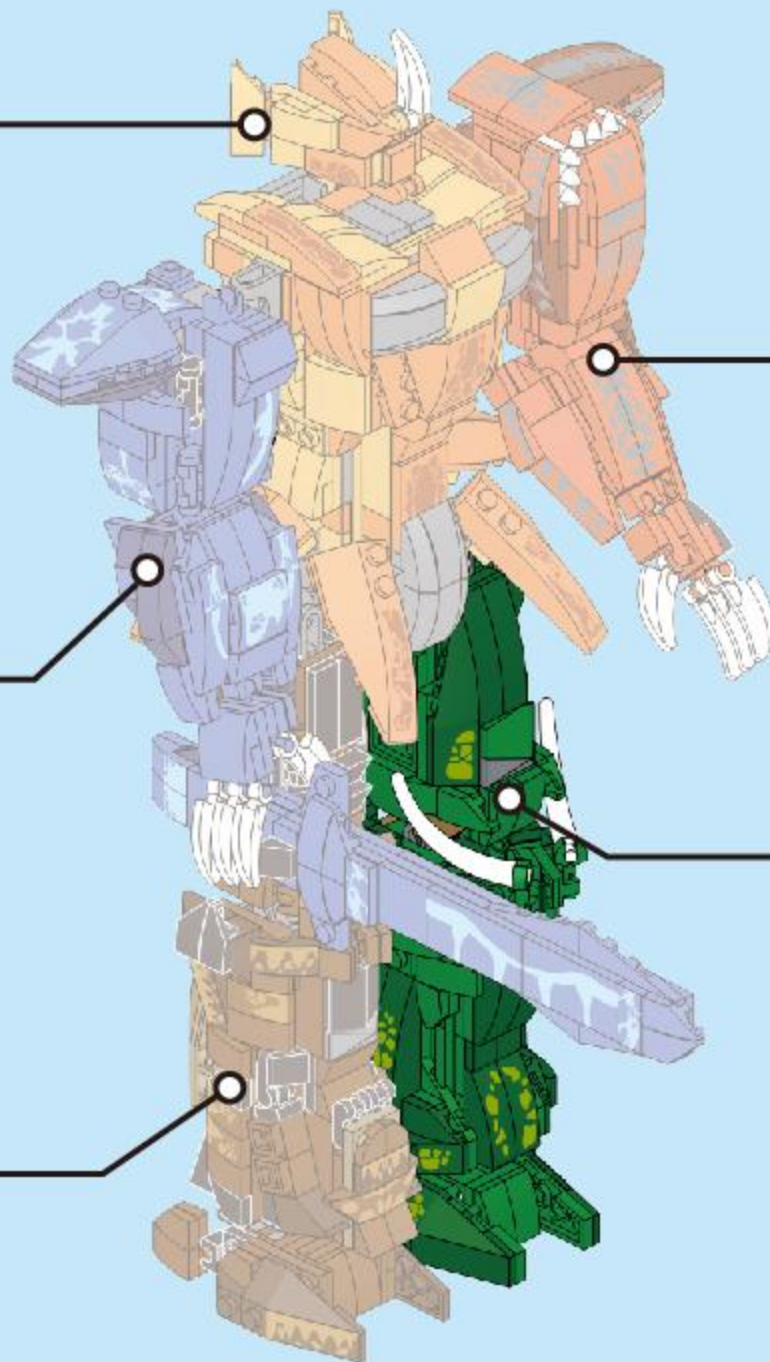

**2 IN 1**  
TRANSFORMS



 **COLLECT 5 MODELS**  
TO COMBINE ZEUS MARS