

FC1034



2 IN 1
TRANSFORMS



COLLECT 5 MODELS
TO COMBINE GOD OF WAR ODIN

拆件器使用方法，仅为示例

Usage of Brick Separator, Just for the sample

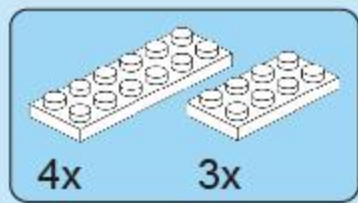
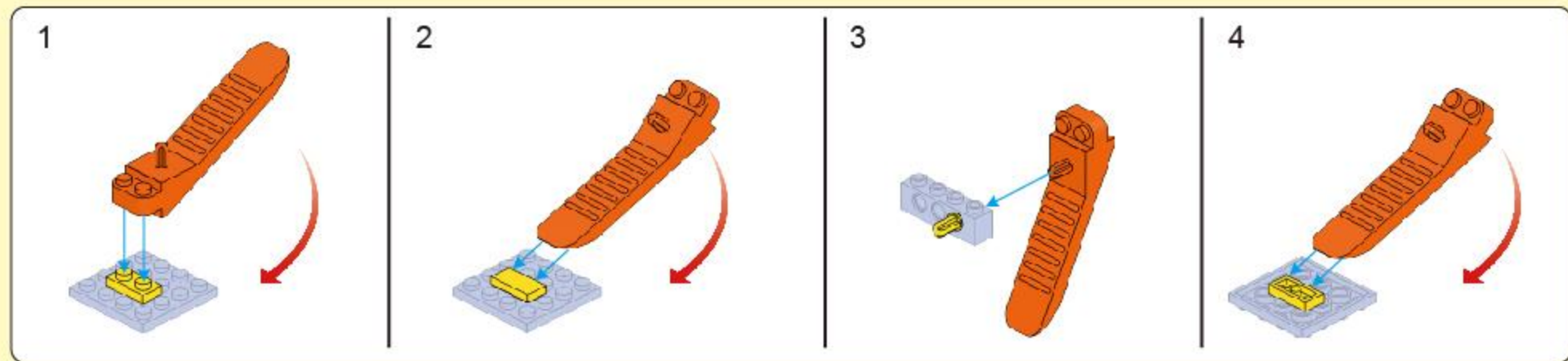

A1

2

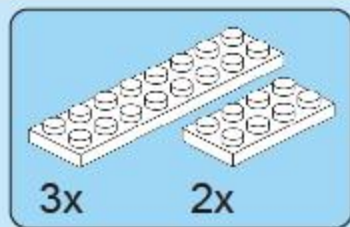
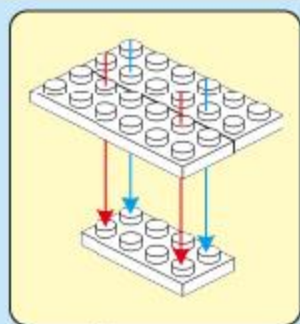

A2

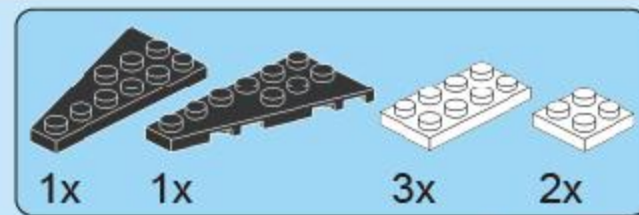
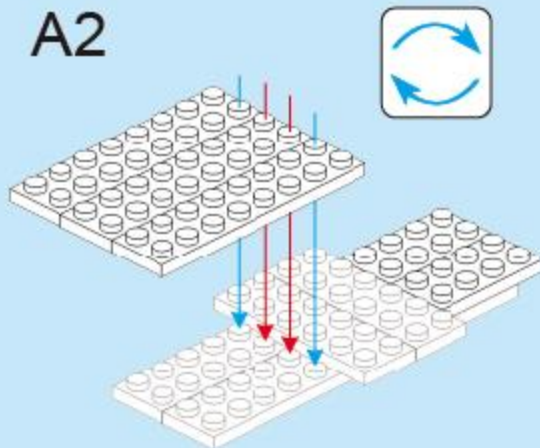

A3

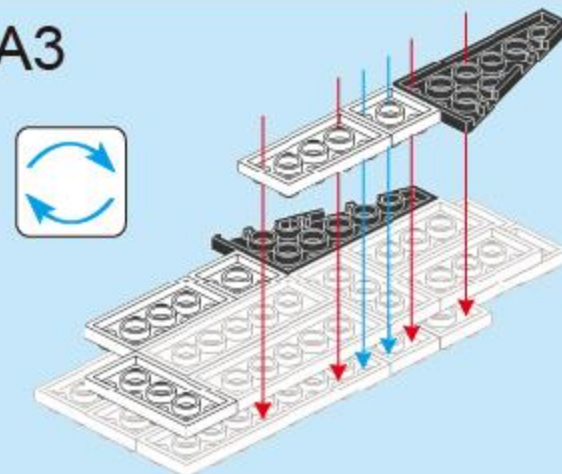

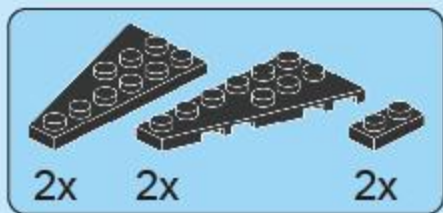

A4

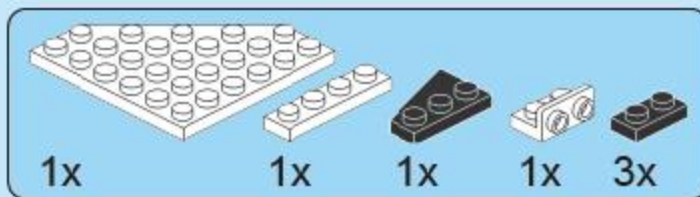
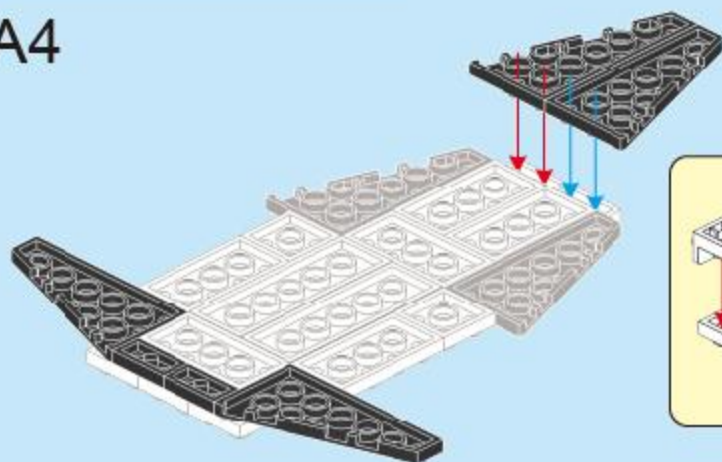

A5

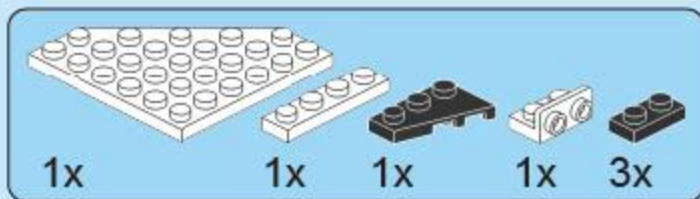
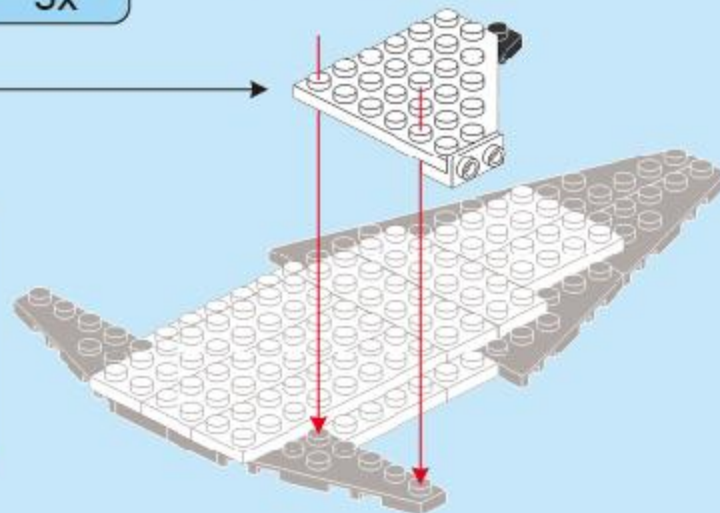
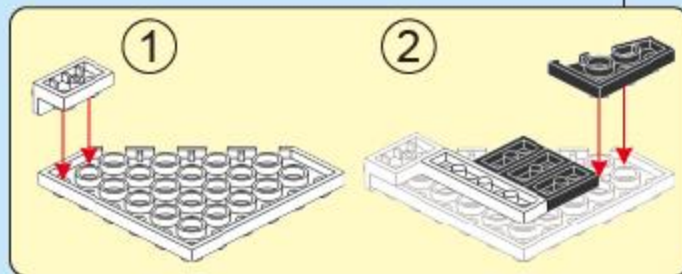

A6

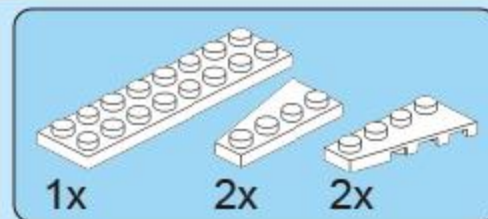
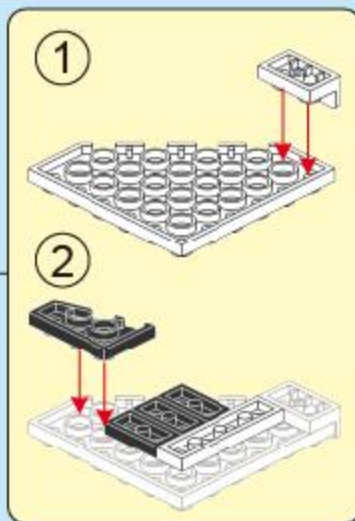
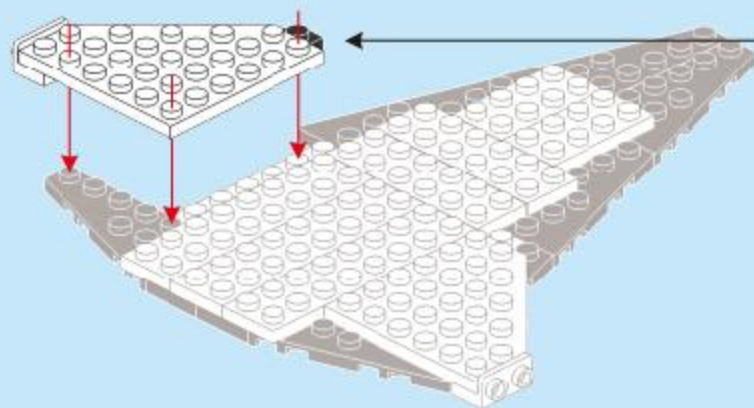

A7

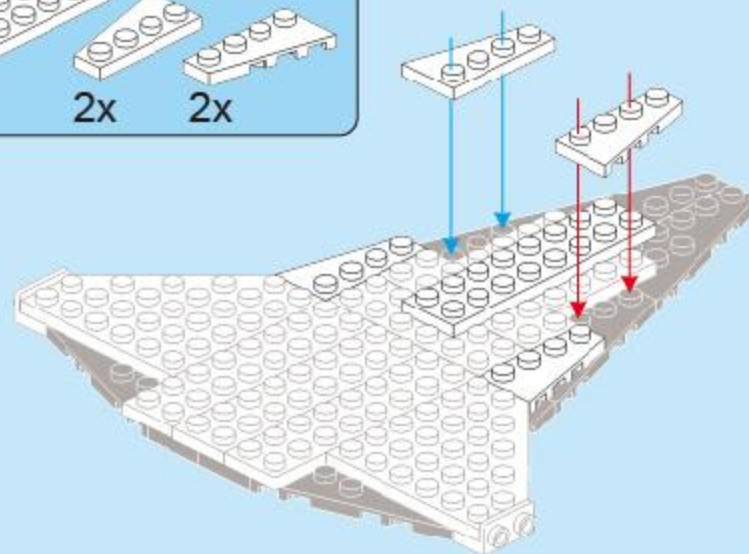

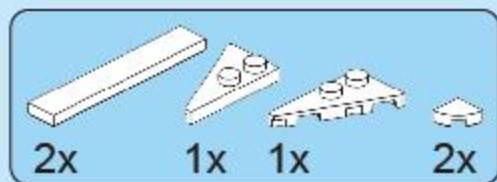

A8

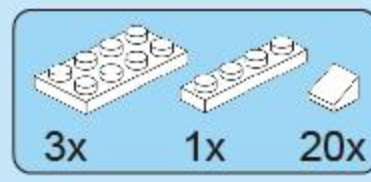
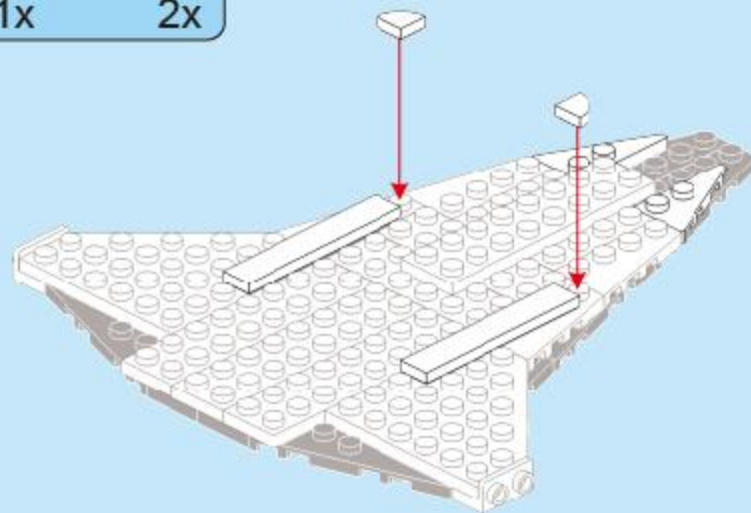

A9

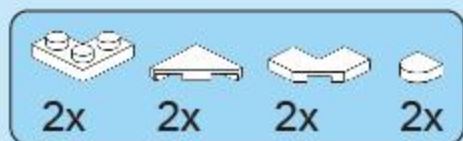
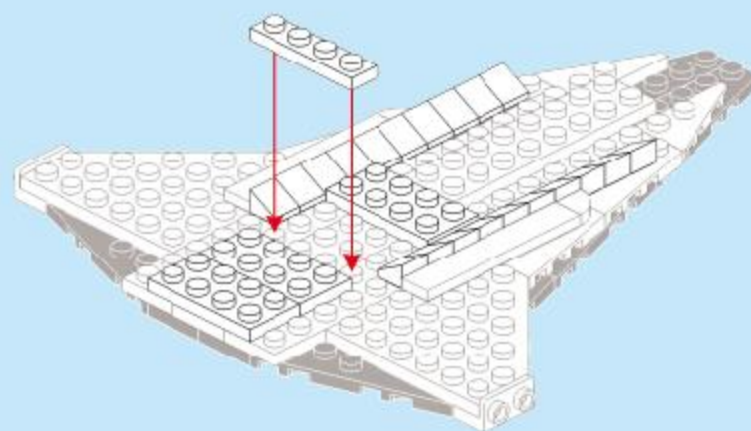

A10

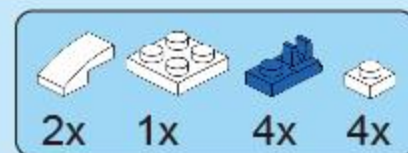
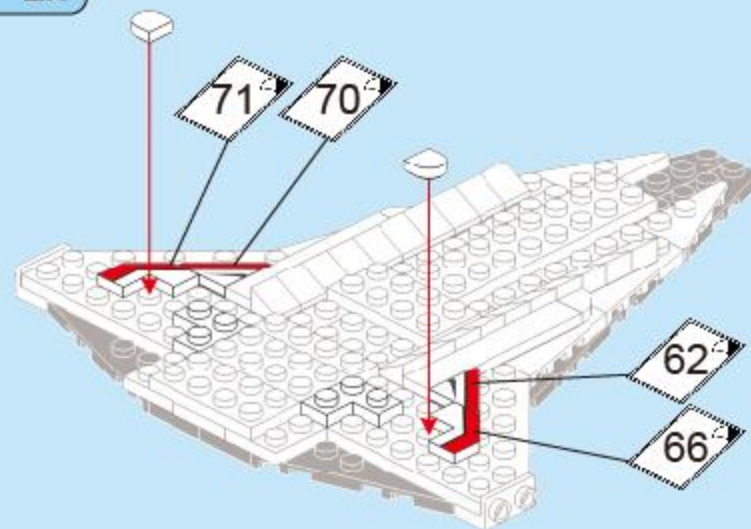

A11

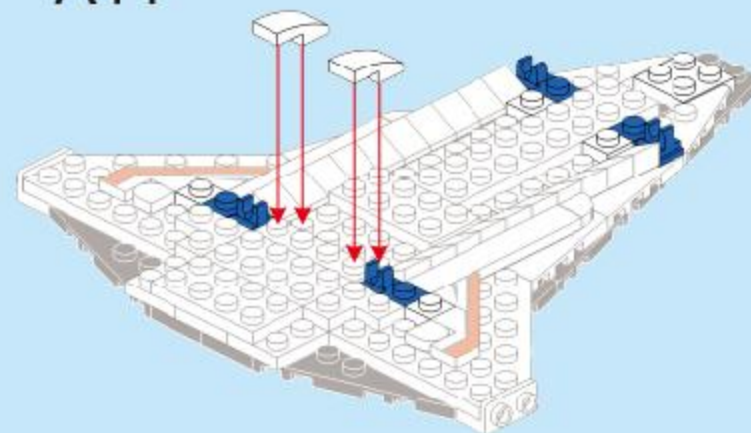

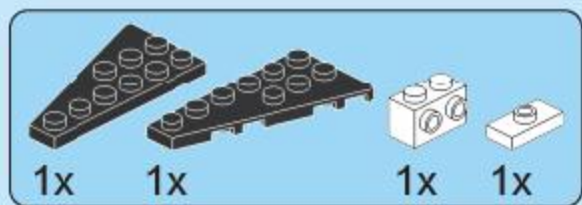

A12

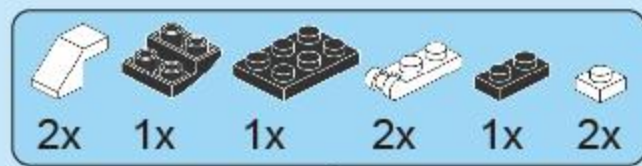
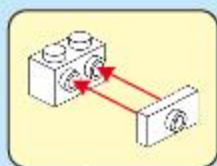
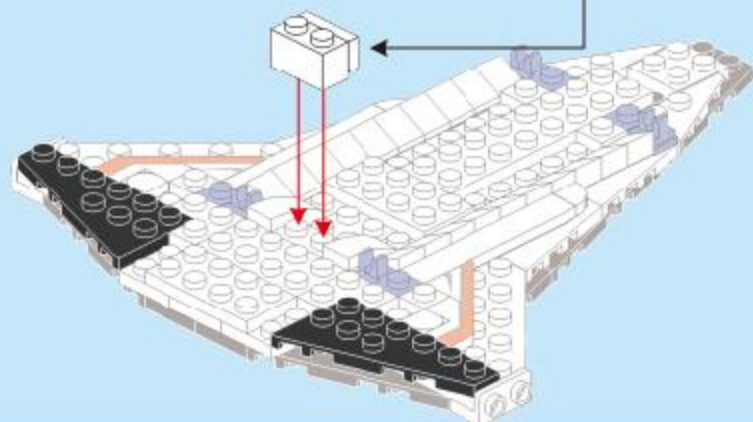

A13

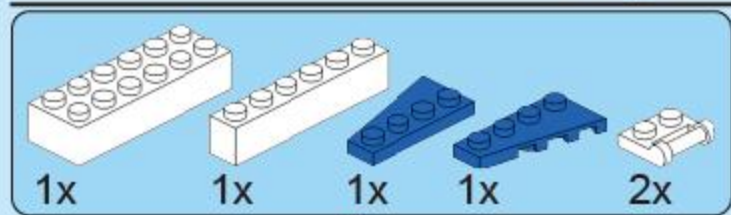
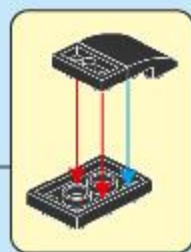
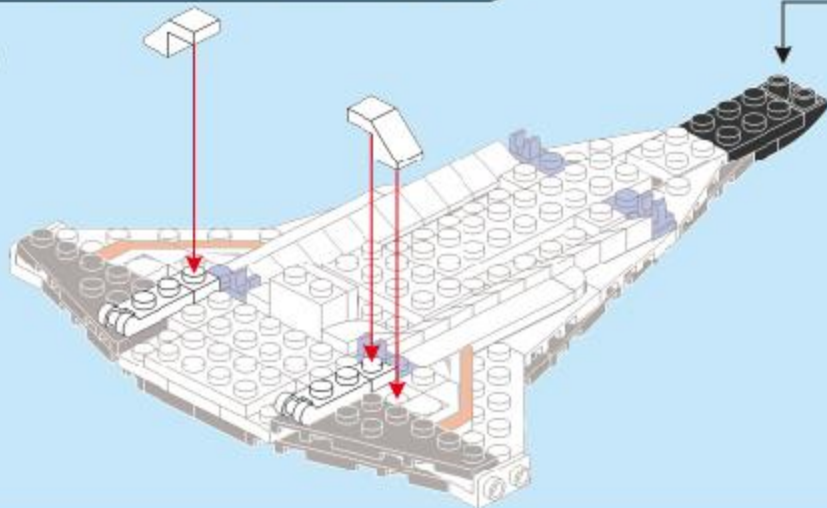

A14

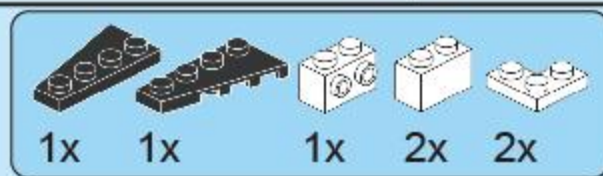
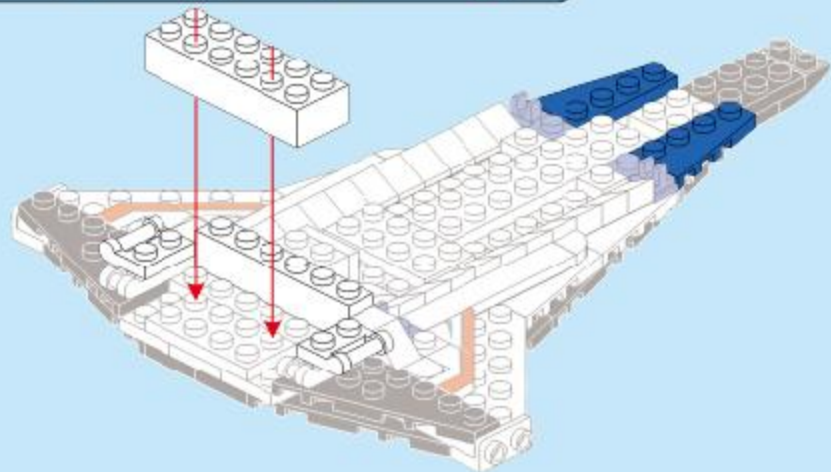

A15

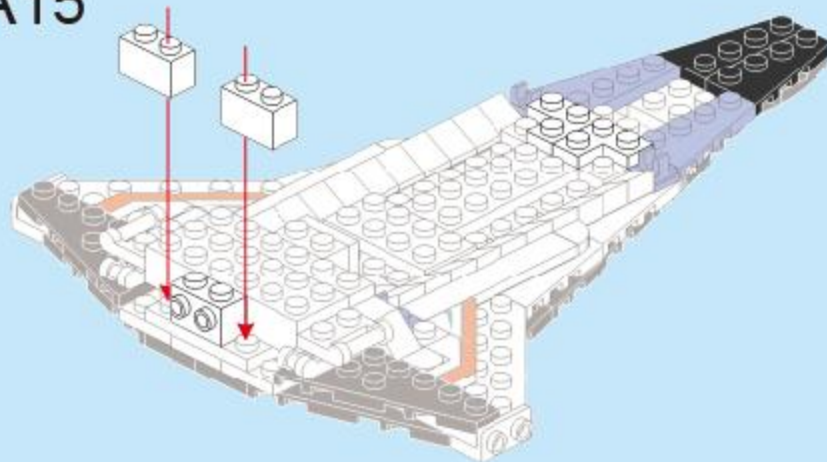

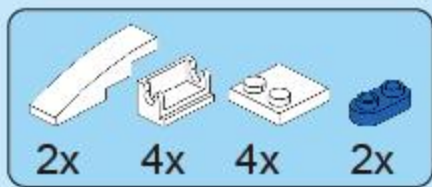

A16

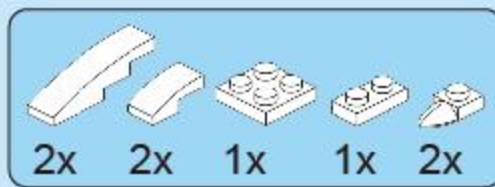
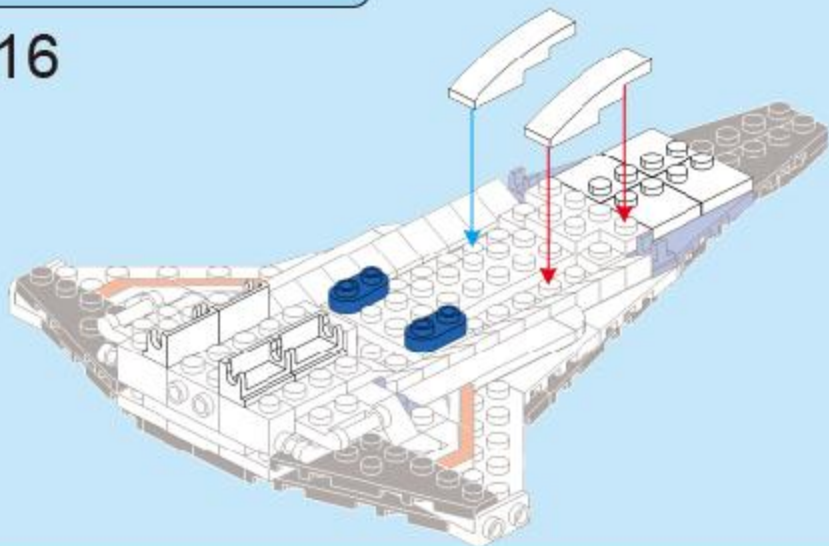

A17

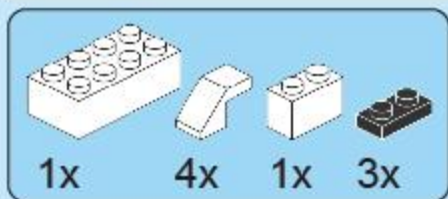
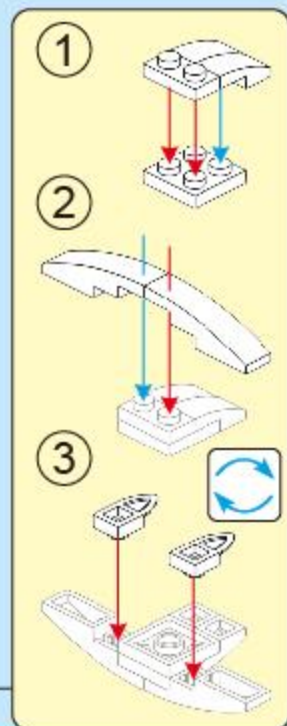
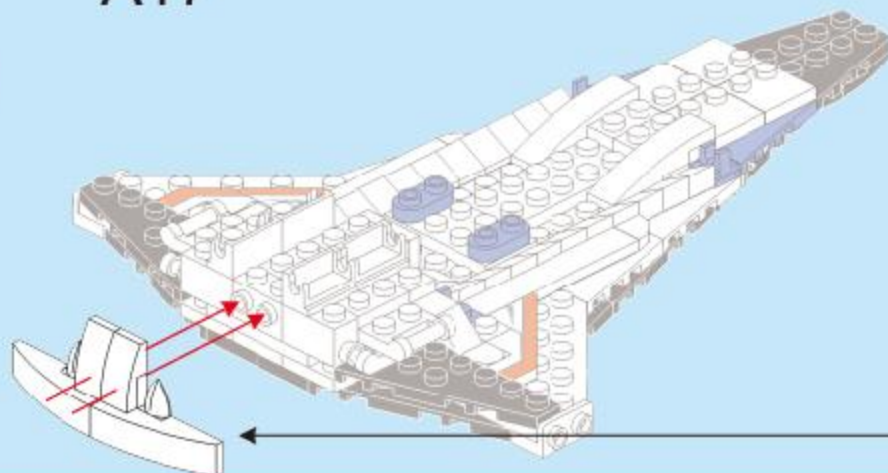

A18

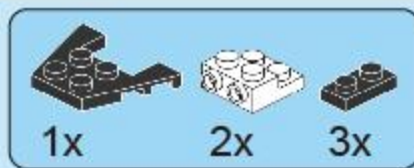
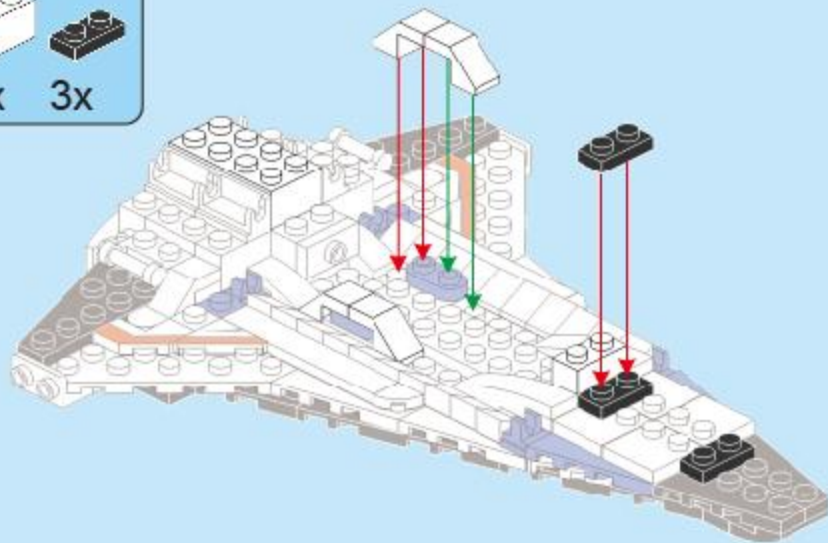

A19

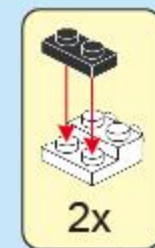

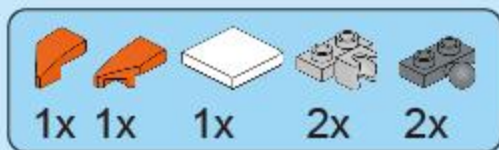

A20

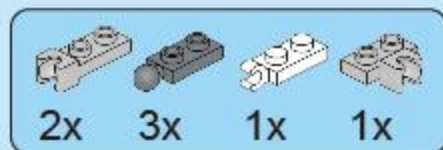
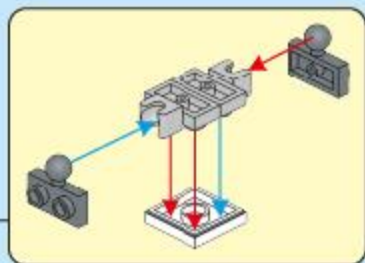

A21

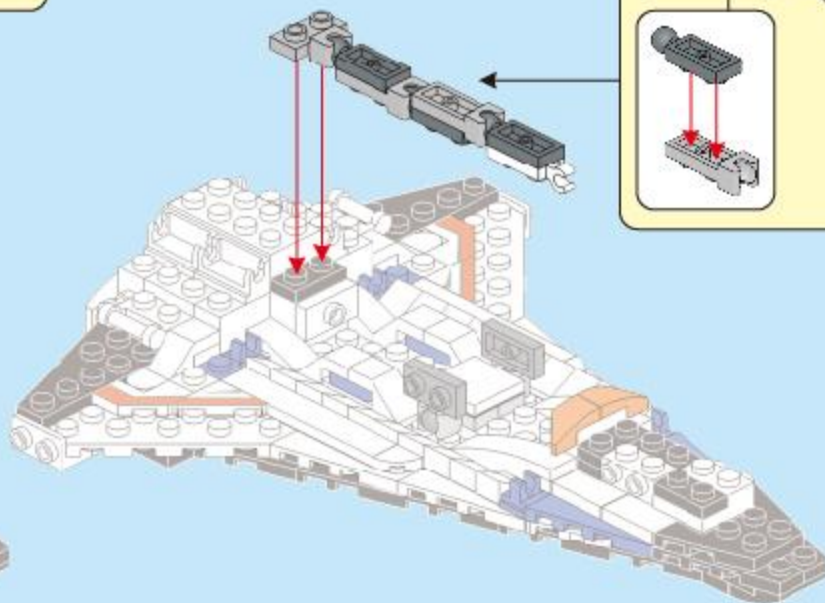
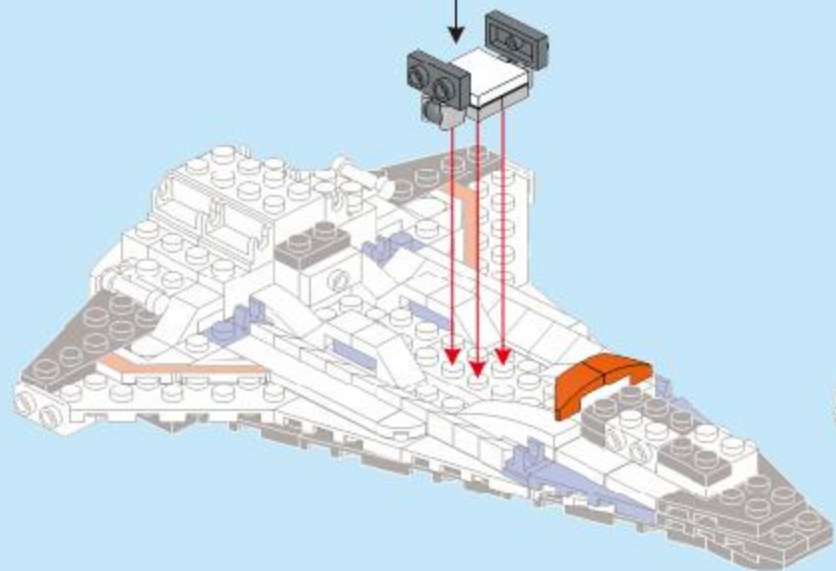
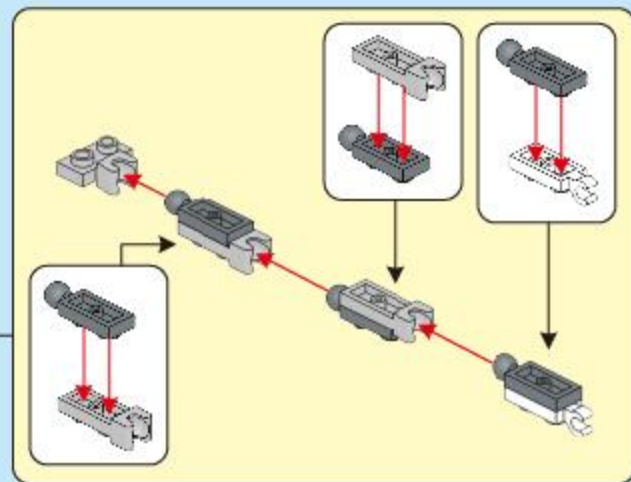

A22

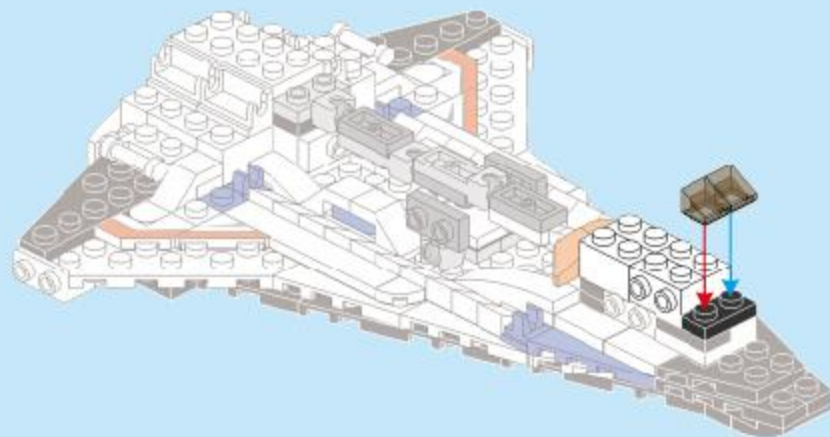



A30

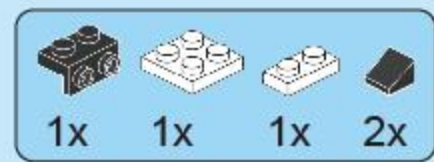
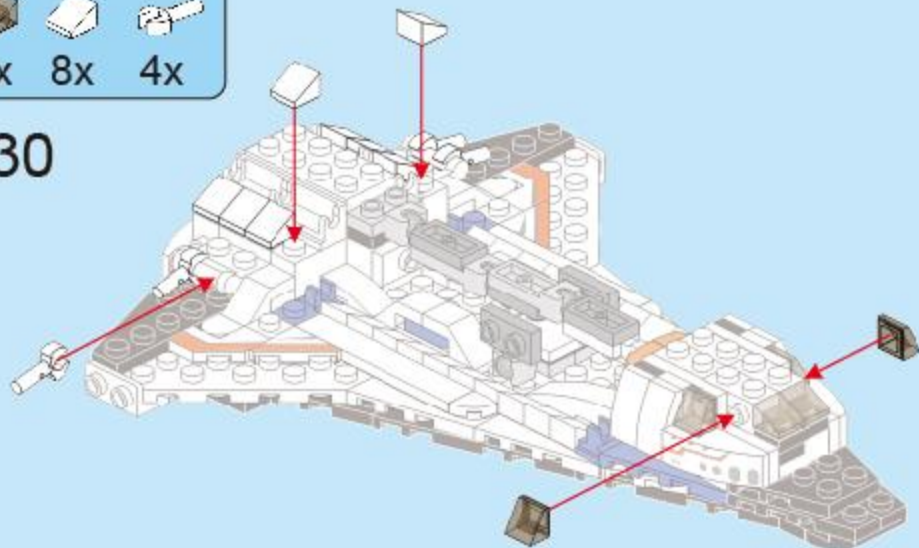

A31

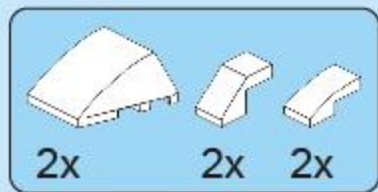
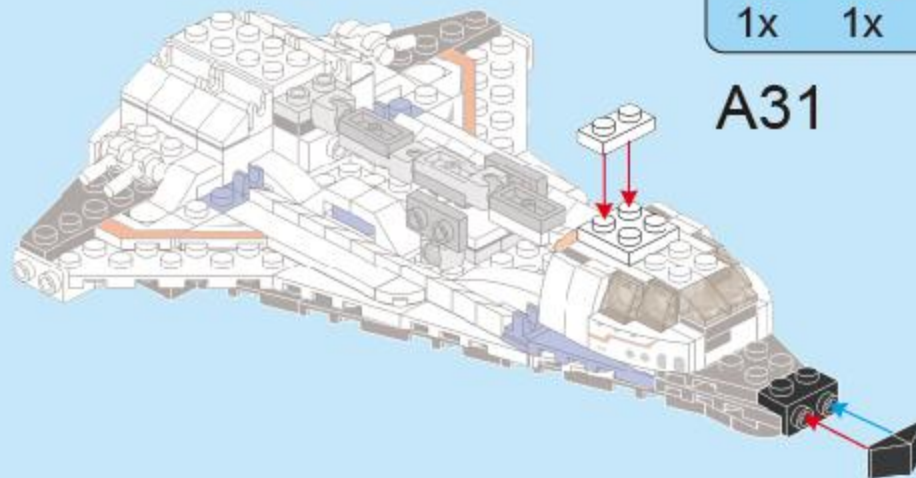

A32

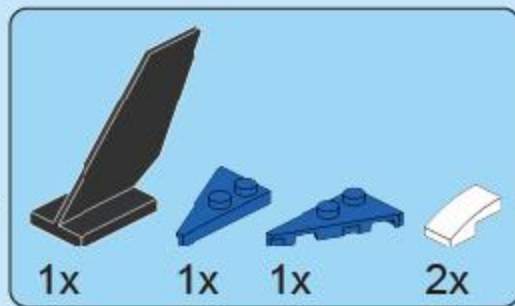
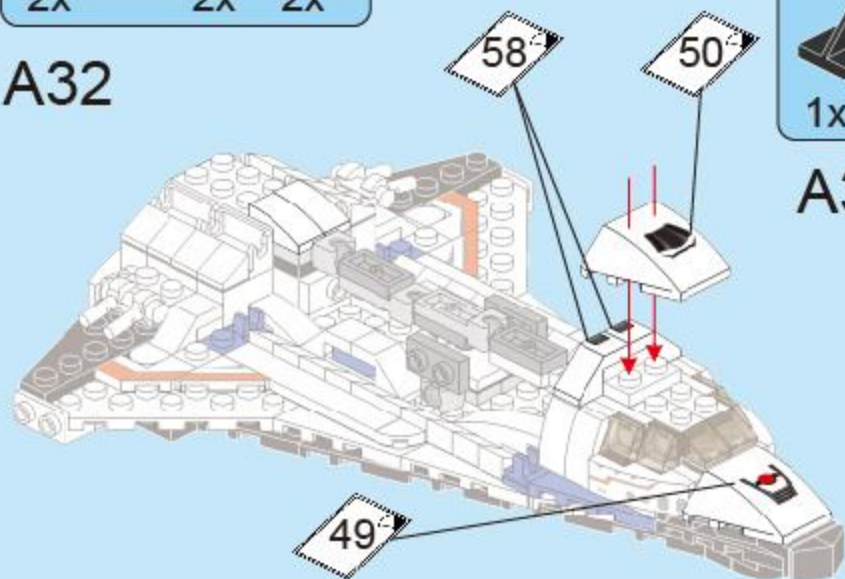

A33

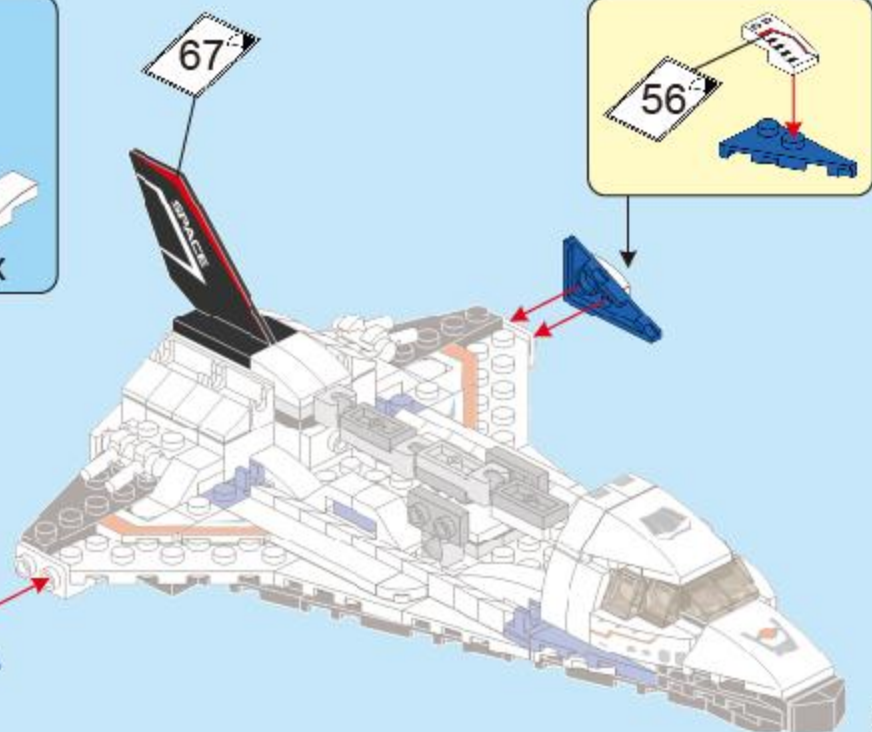
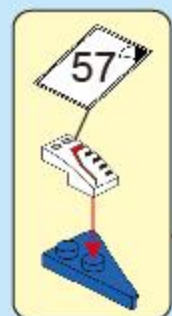

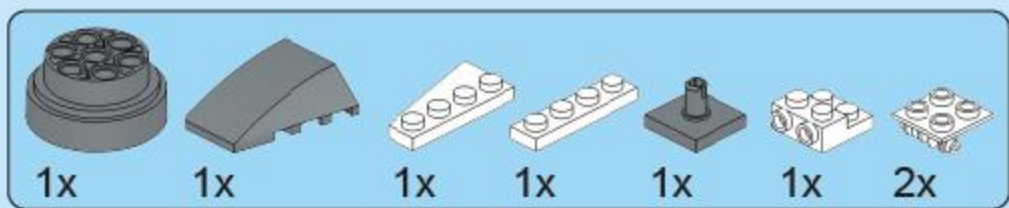

A34

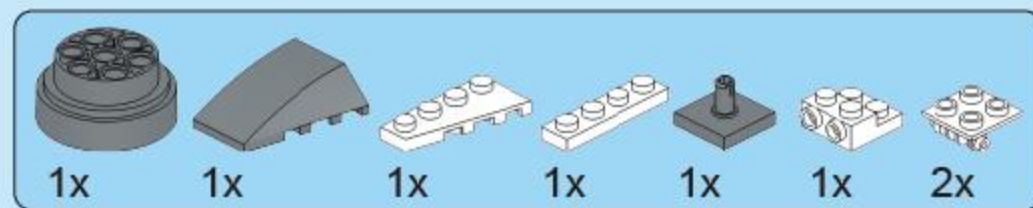
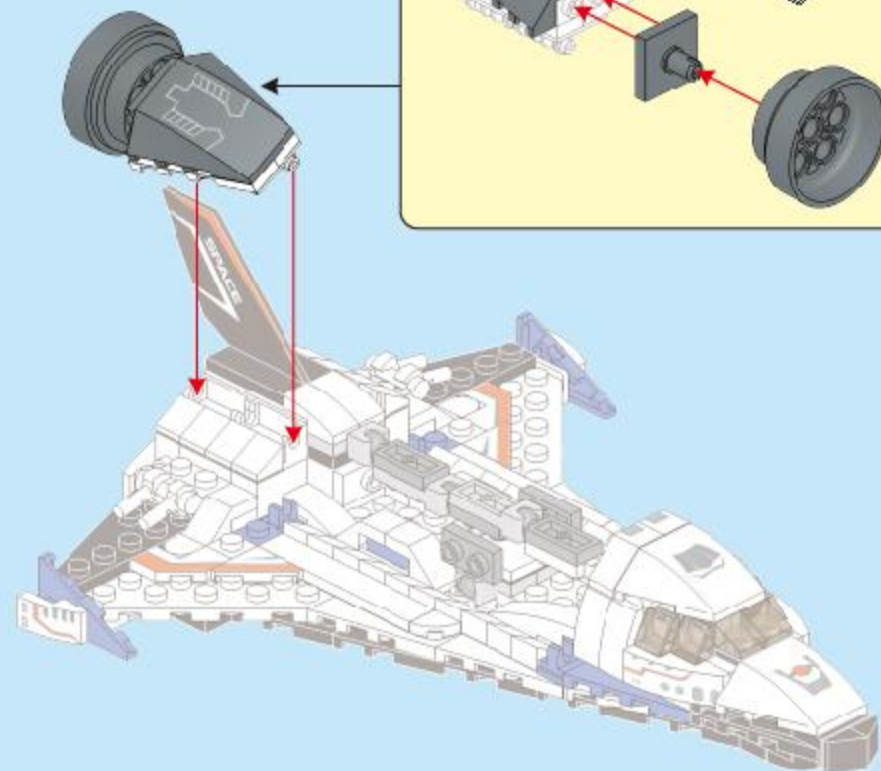
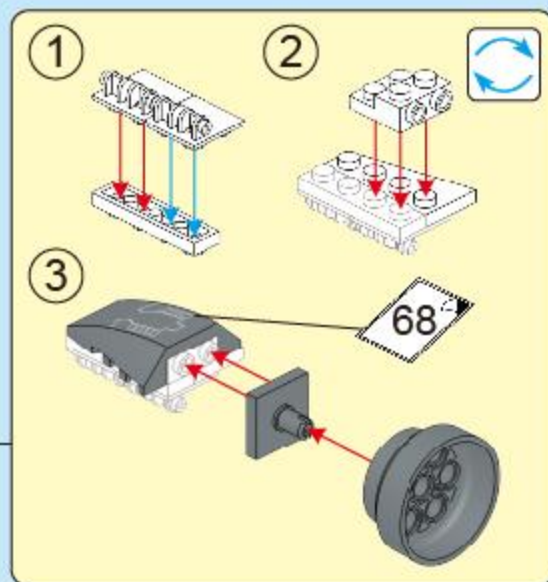

A35

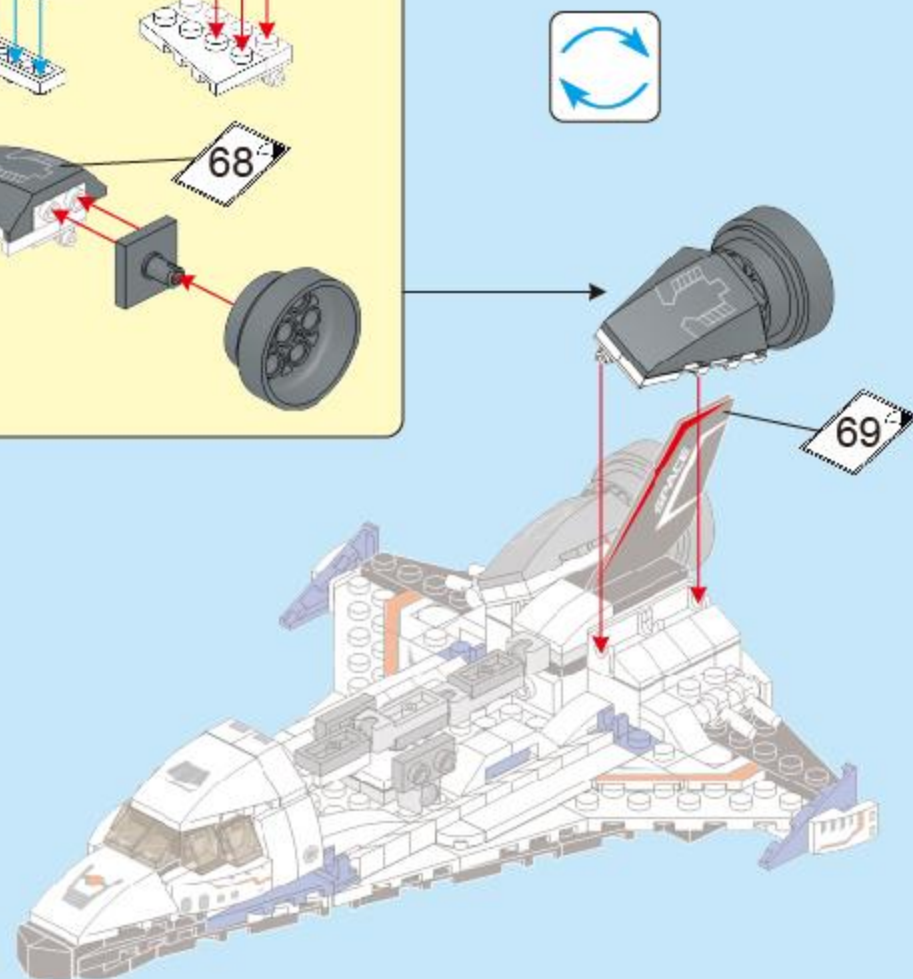
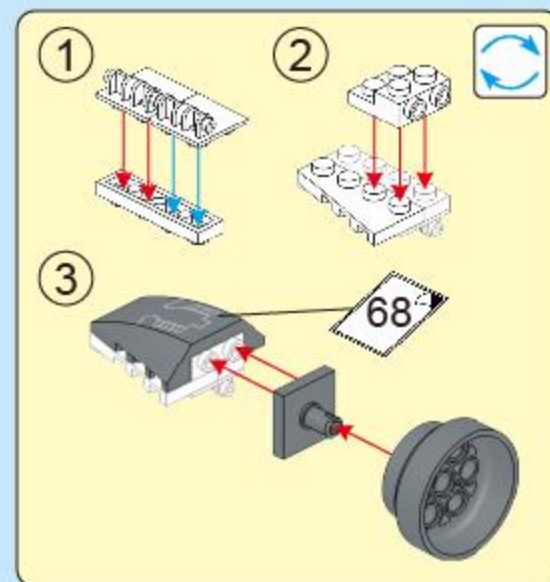

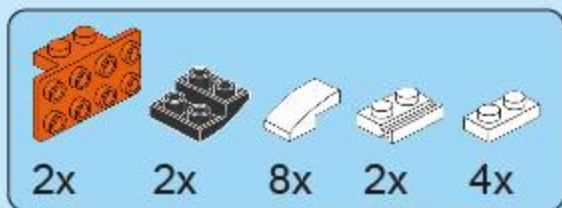

A36

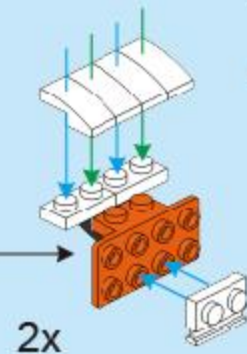
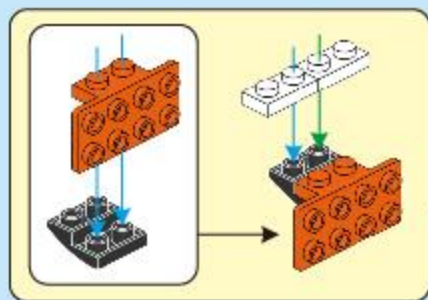

A37

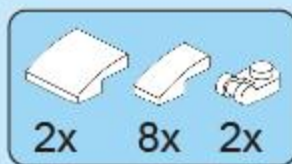
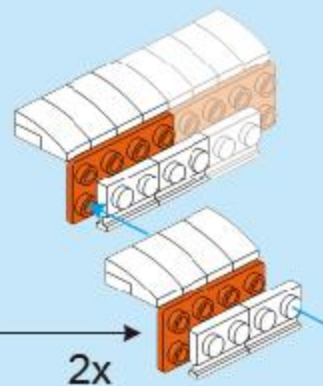
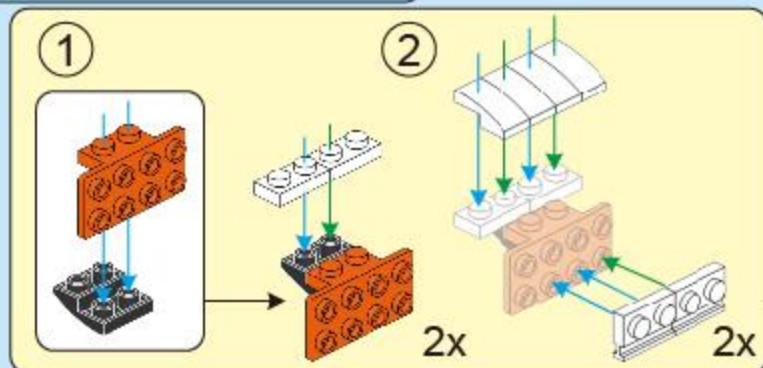

A38

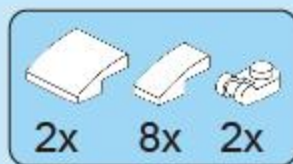
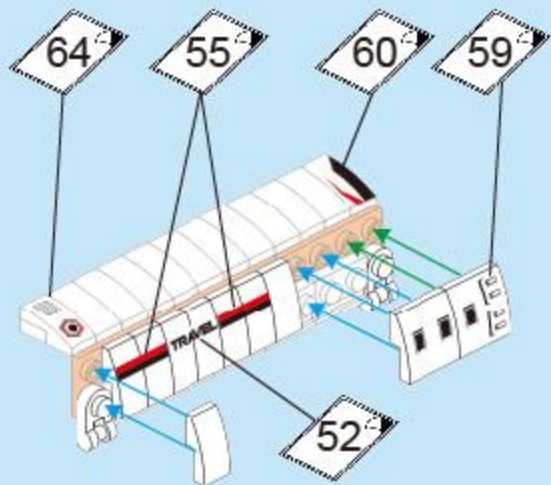

A39

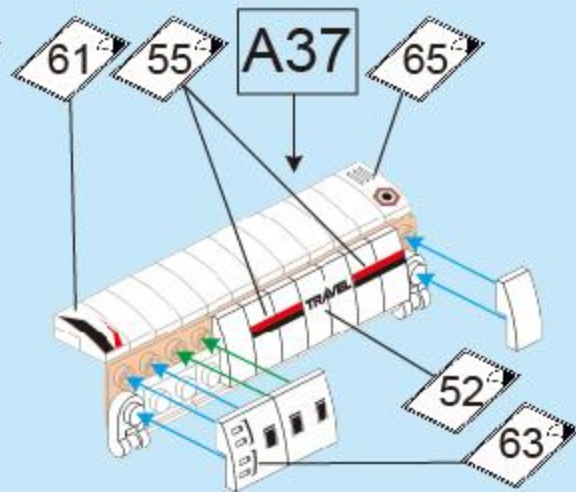

A40

A38

A39

A35

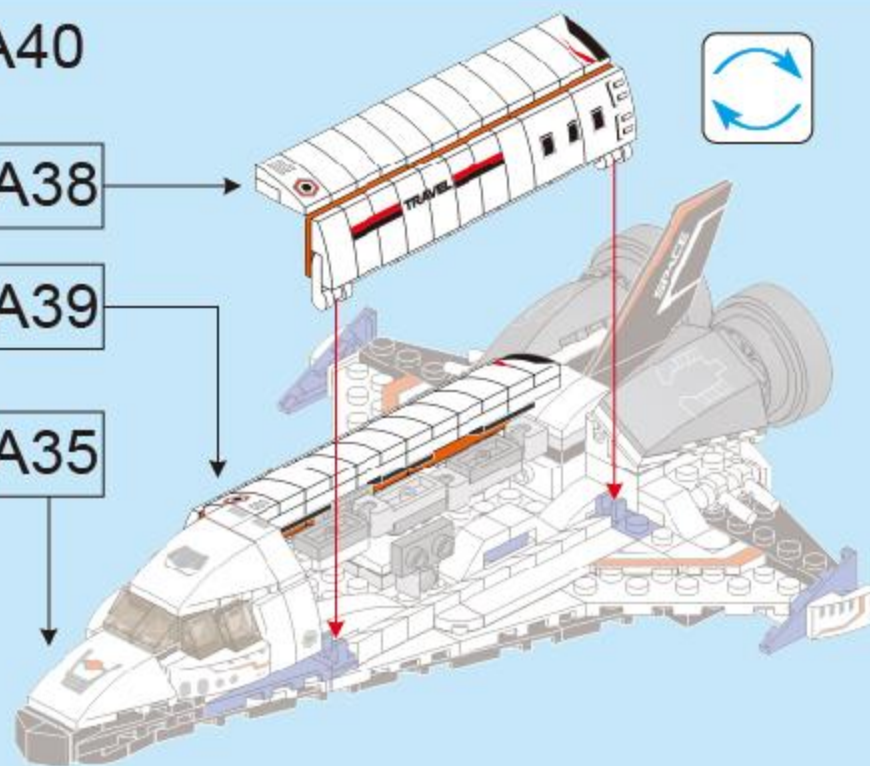

A

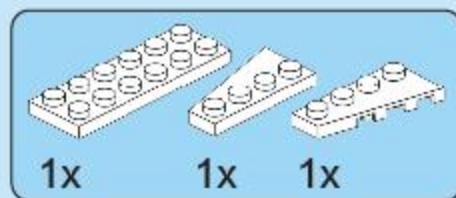
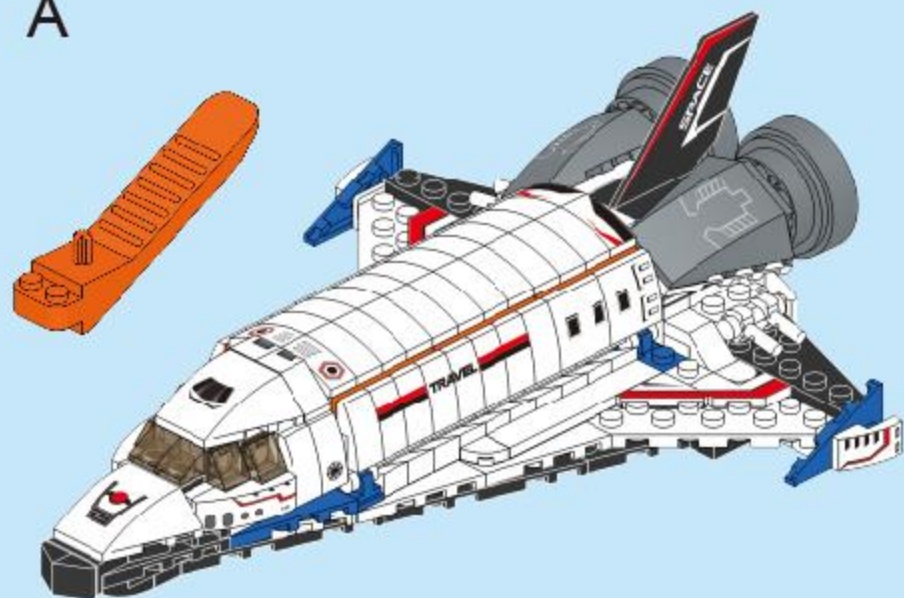

B1

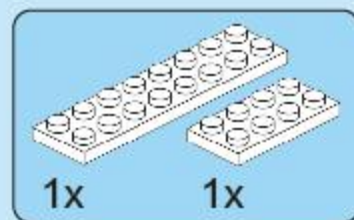

B2

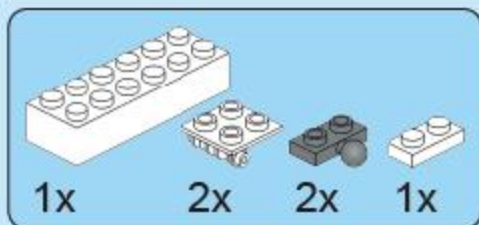
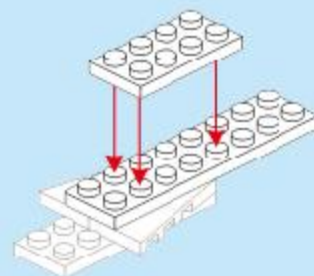
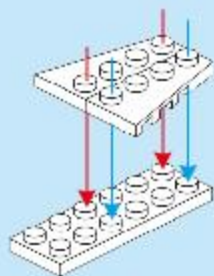

B3

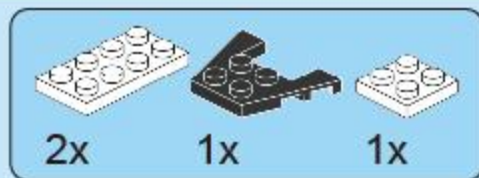

B4

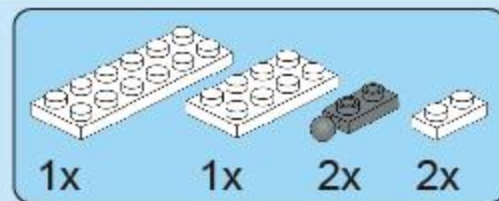

B5

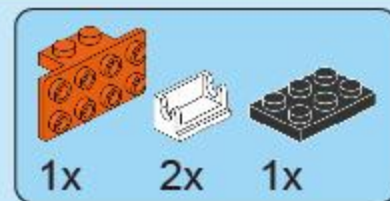

B6

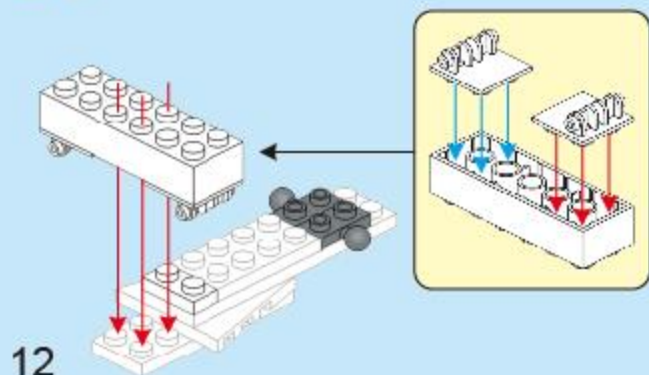

12

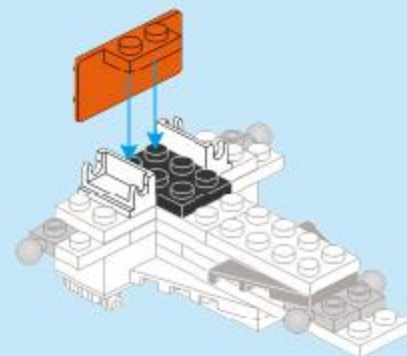
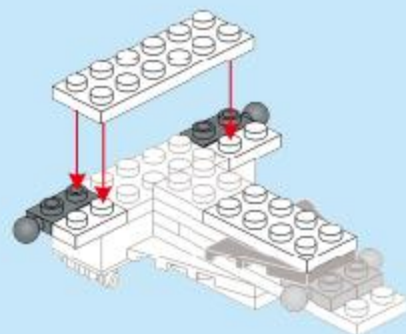
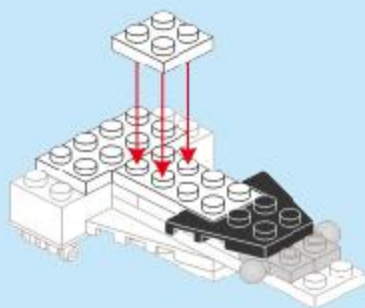

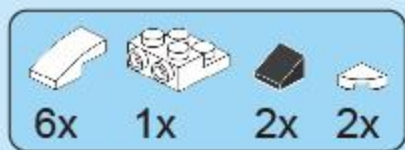

B7

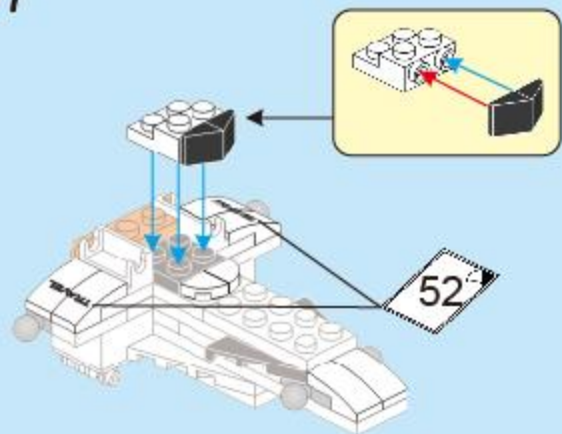

B8

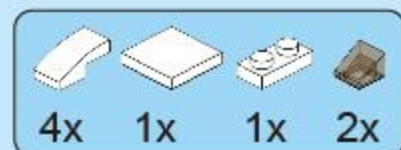
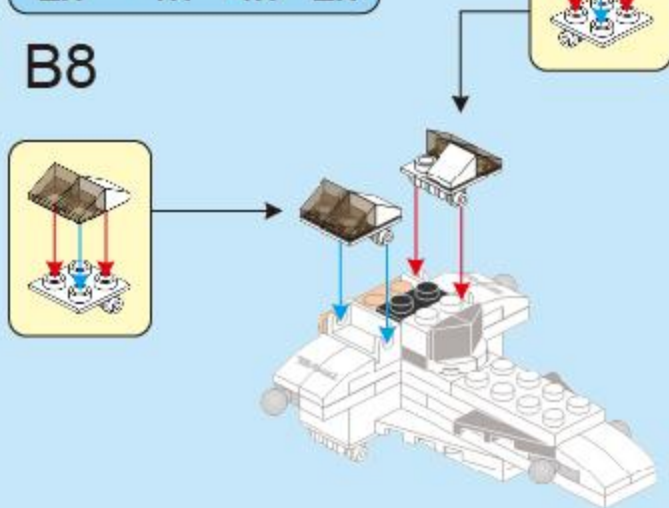

B9

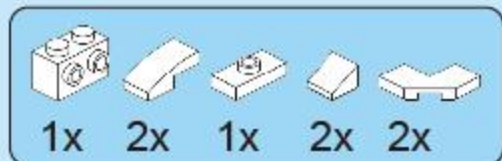
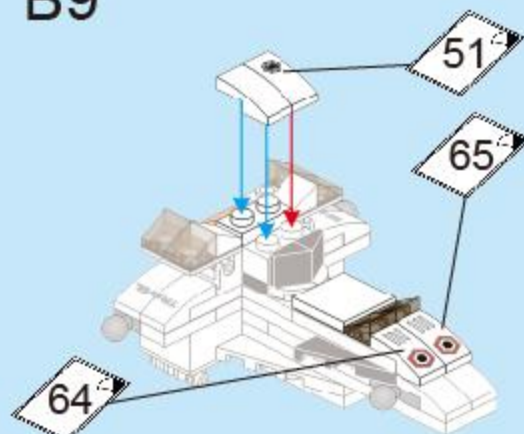

B10

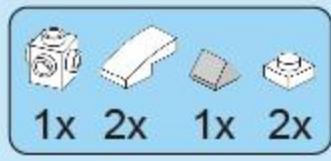
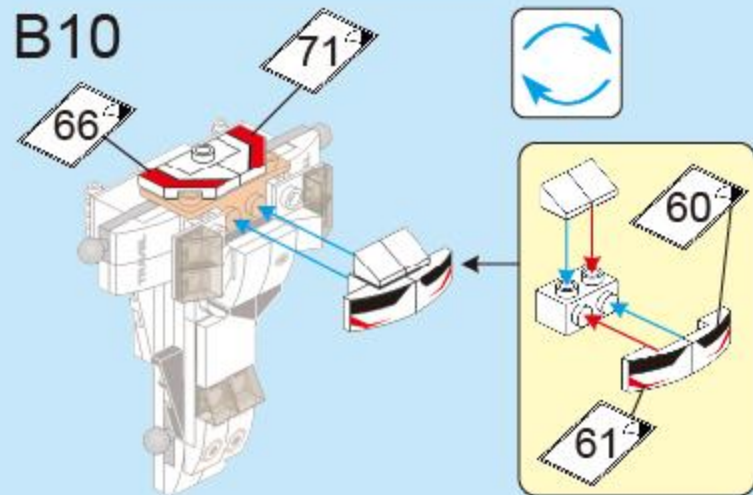

B11

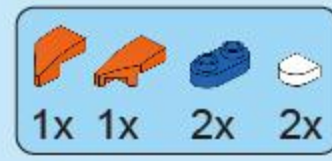
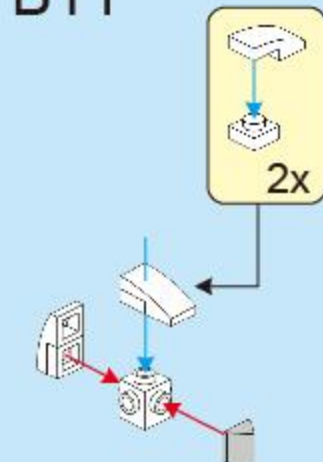

B12

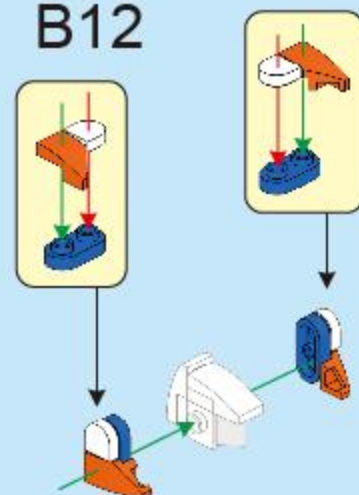

B13

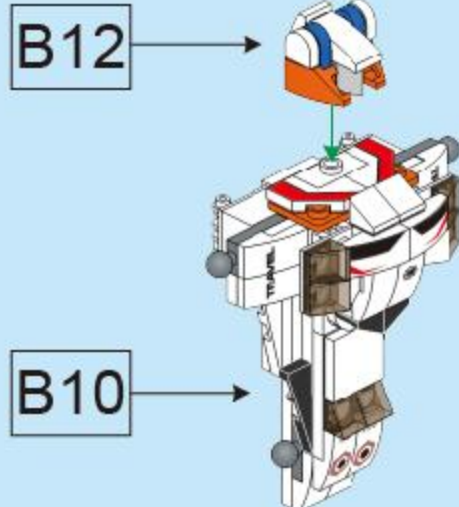

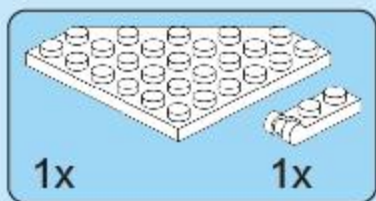

B14

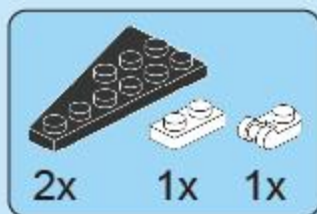
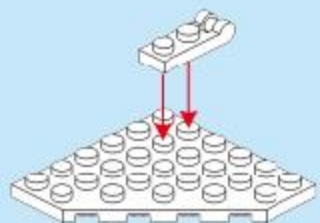

B15

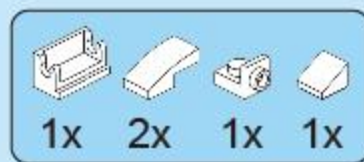

B16

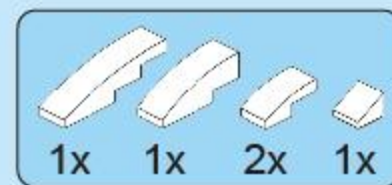
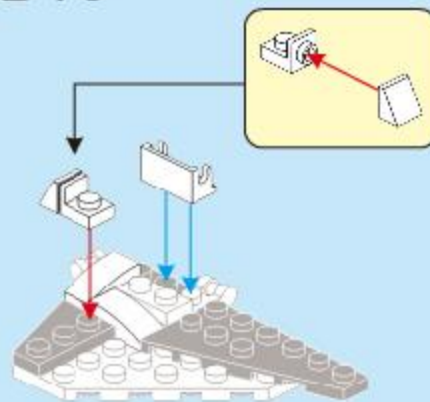

B17

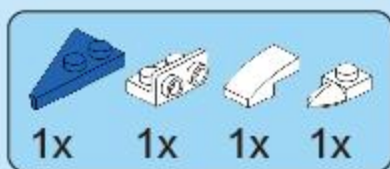
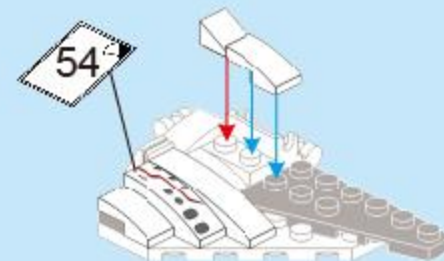

B18

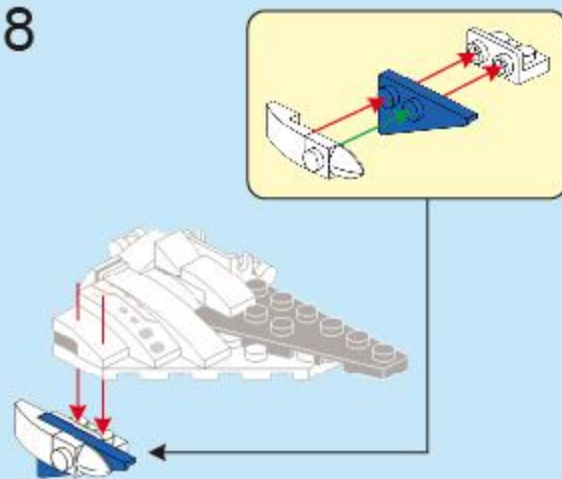

14

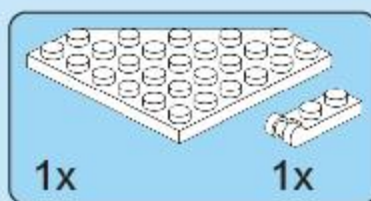

B19

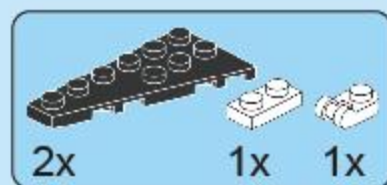
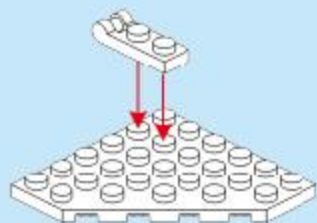

B20

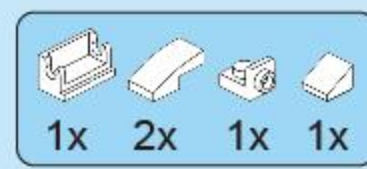

B21

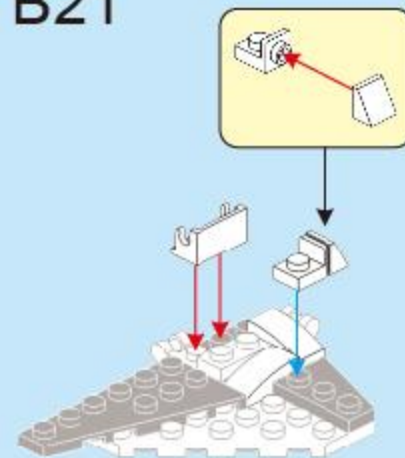

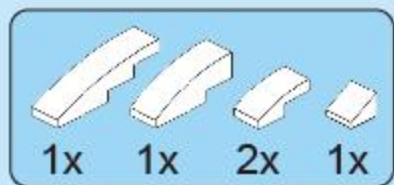

B22

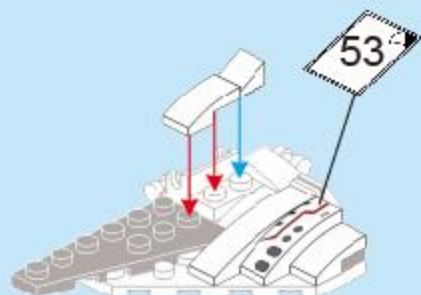

B23

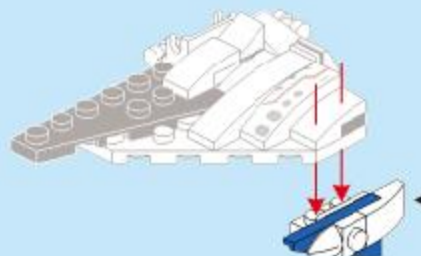
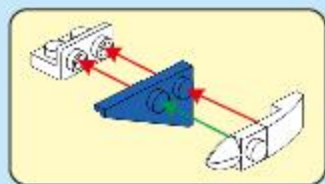

B24

B18

B23

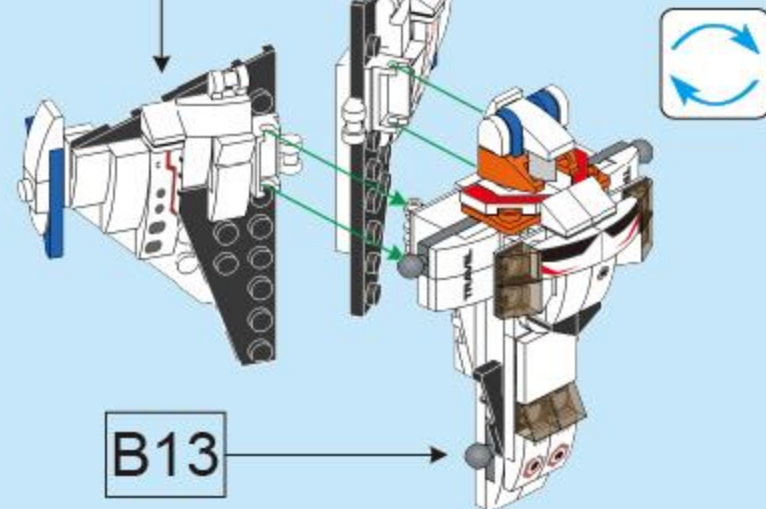

B13

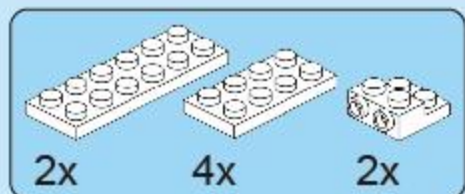

B25

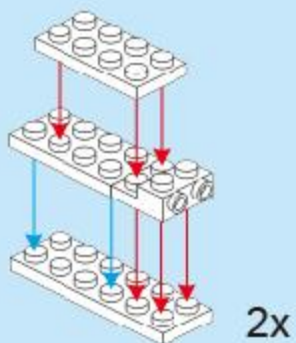

2x

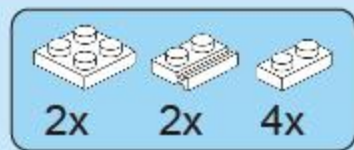

B26

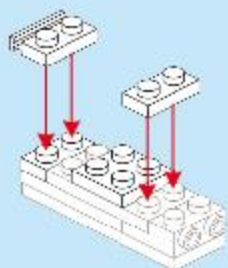

2x

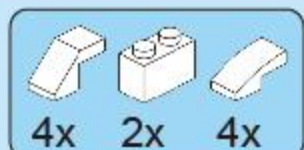

B27

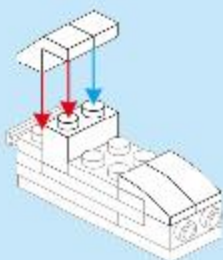

2x

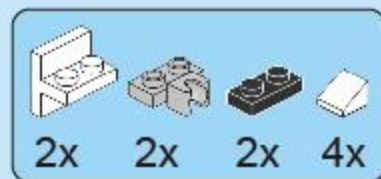

B28

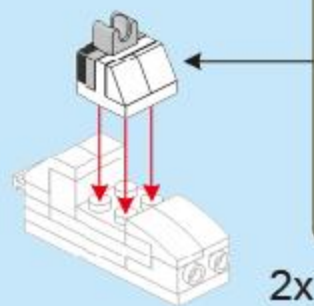

2x

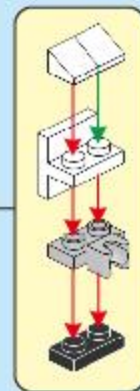

B29



2x

15

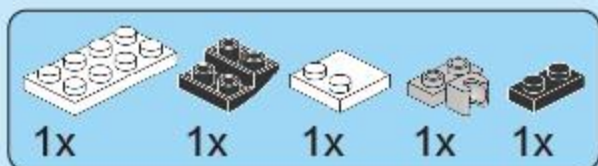

B30

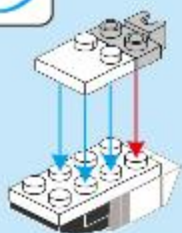
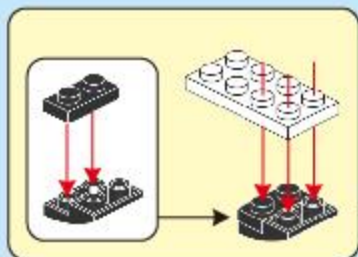

B31

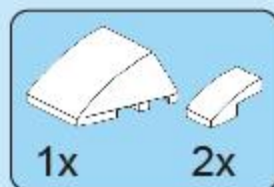
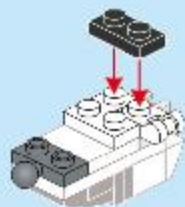

B32

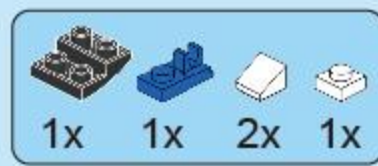
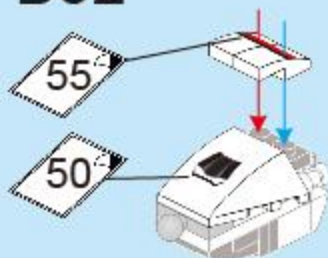

B33

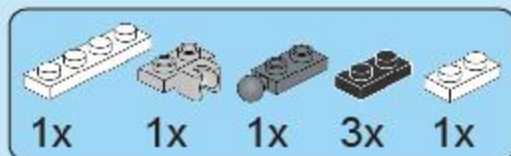
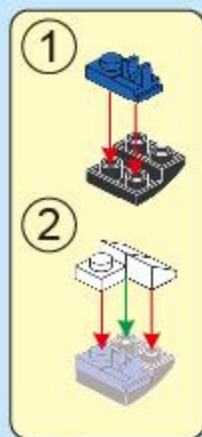
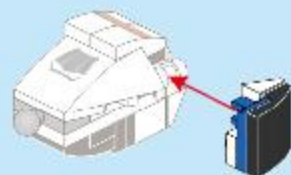

B34

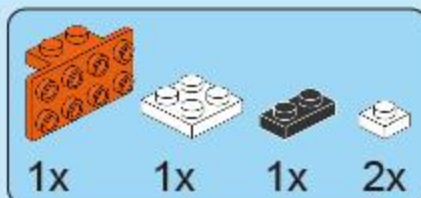
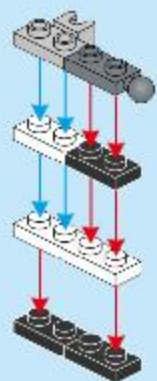

B35

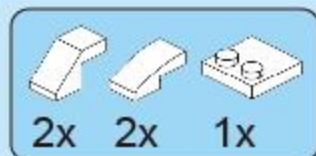
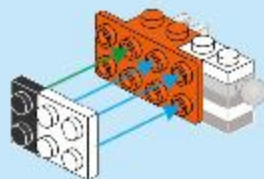

B36

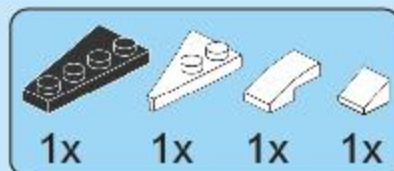
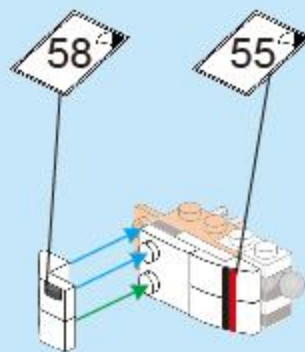

B37

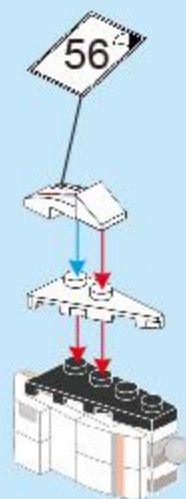

B38

B37



B33



B28

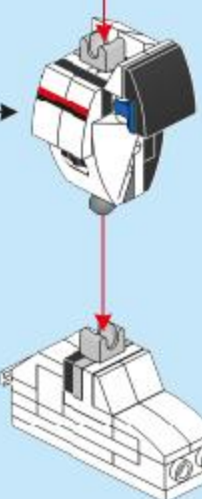

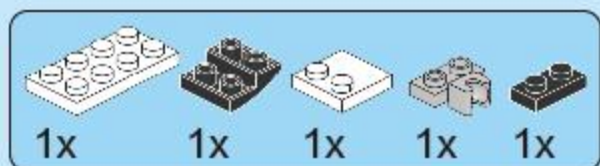

B39

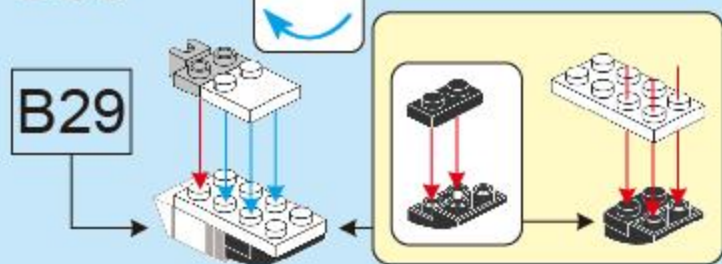

B40

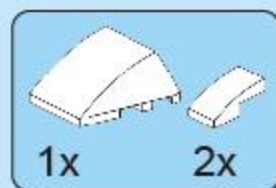

B41

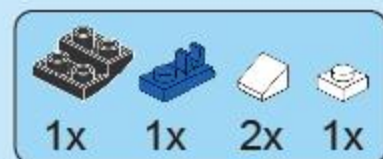
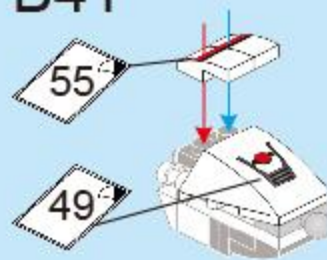

B42

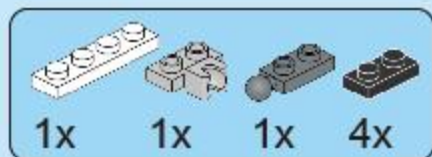
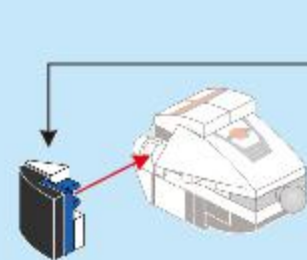

B43

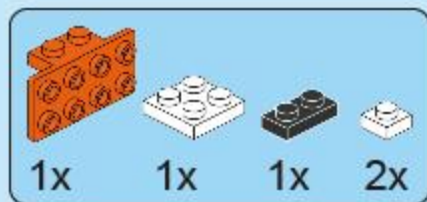

B44

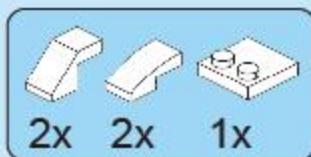
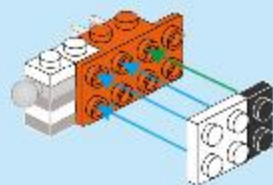

B45

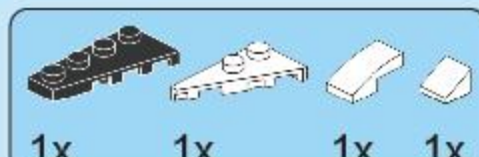
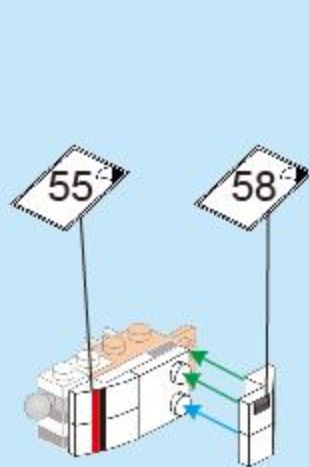

B46

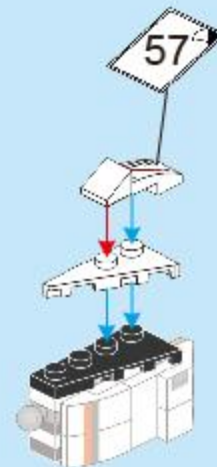

B47

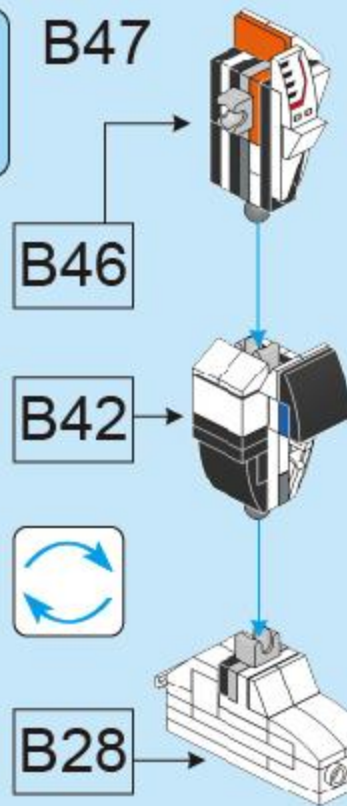

B48

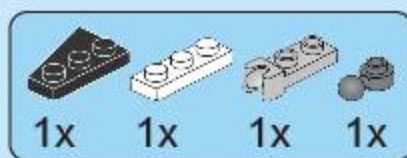
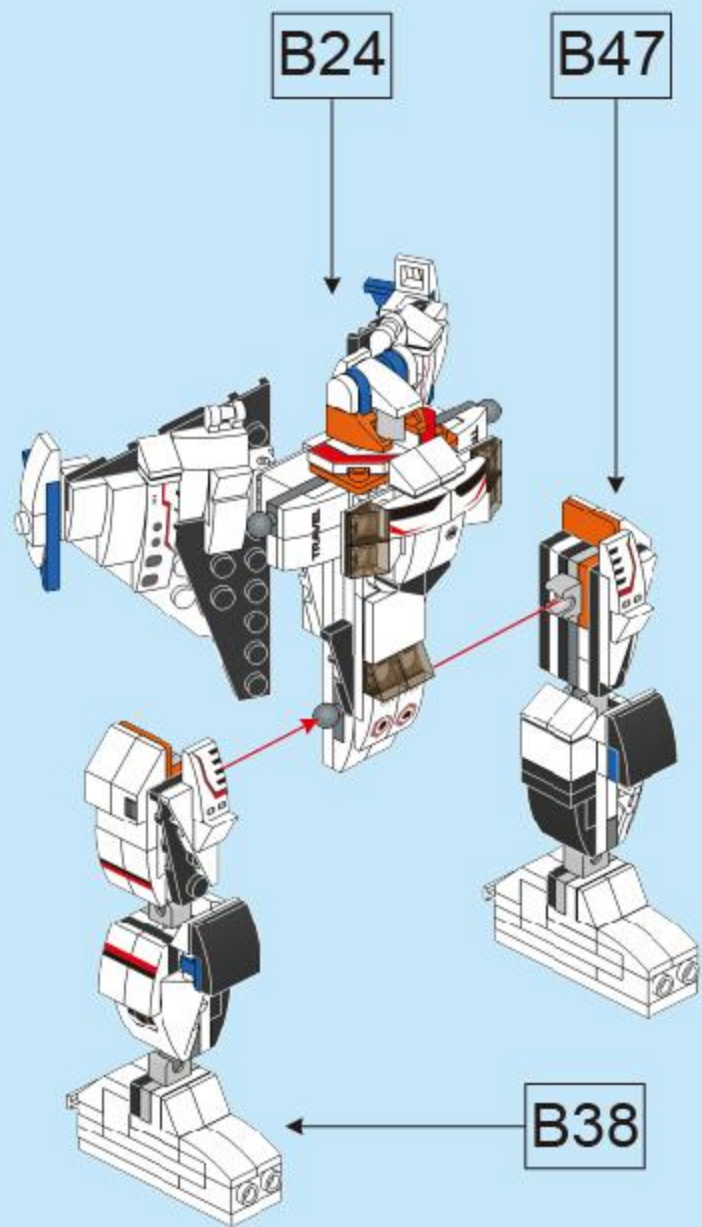

B49

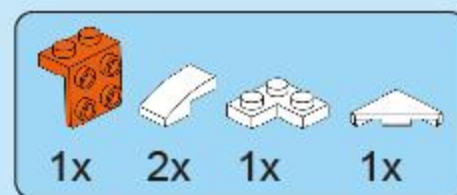
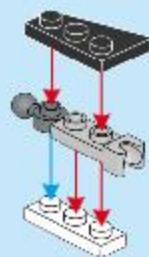

B50

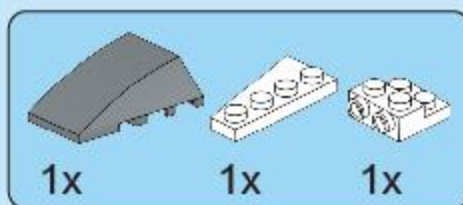
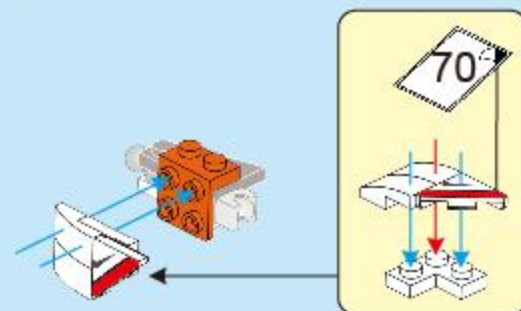

B51

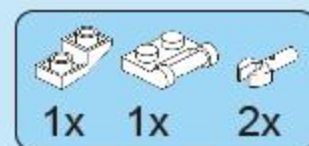
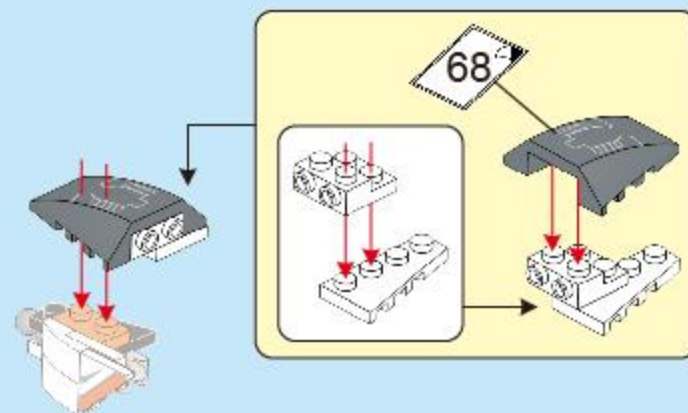

B52

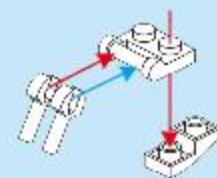

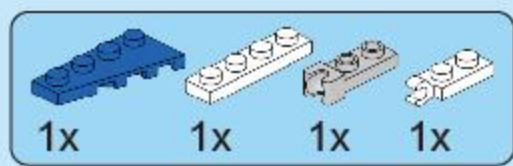

B53

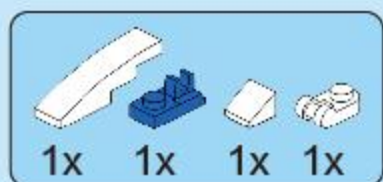
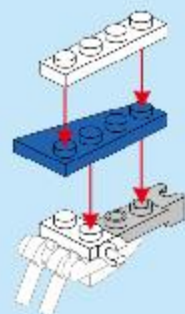

B54

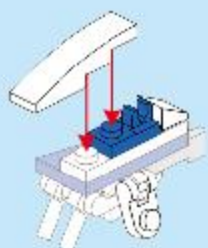

B55

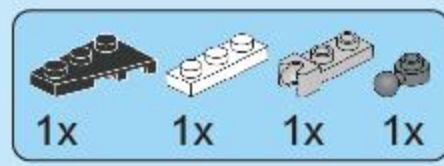

B56

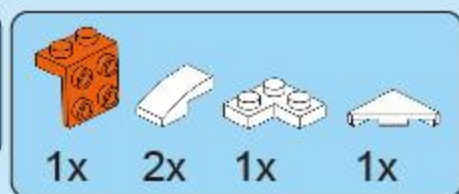
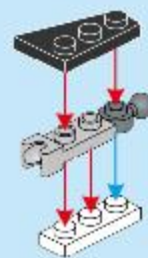

B57

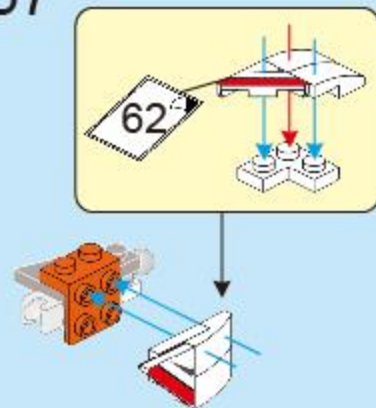

B51



B54

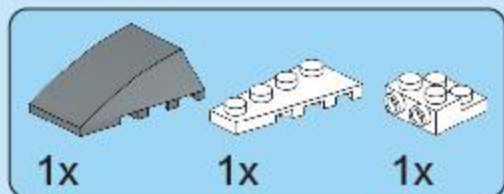
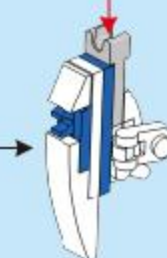

B58

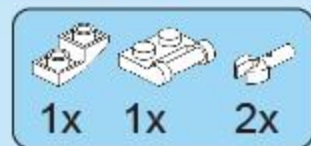
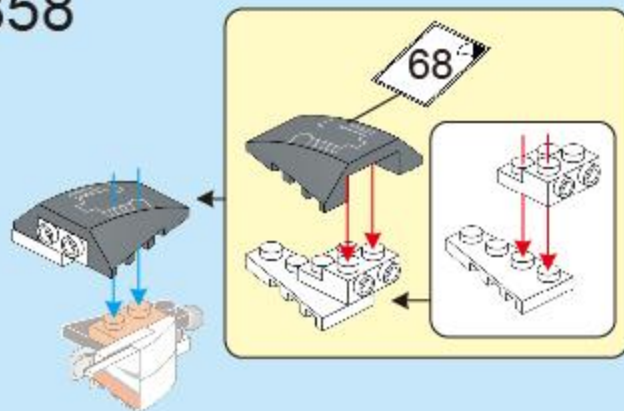

B59

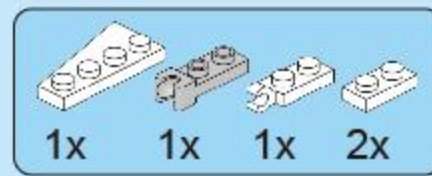
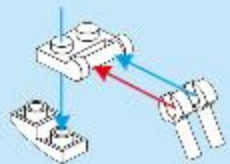

B60

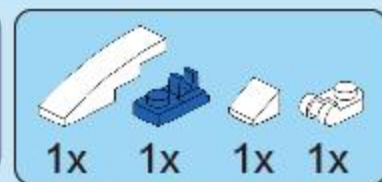
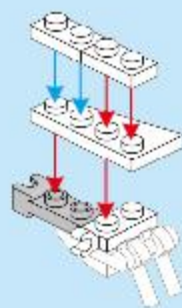

B61

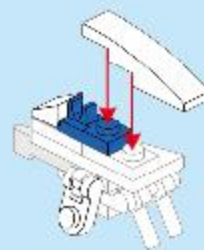

B62

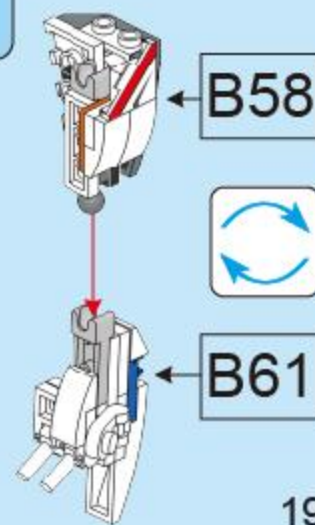

B58

B61

B63

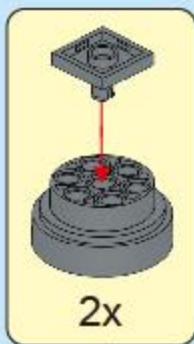
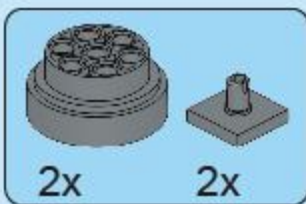

B

B55

B48



B62

B64

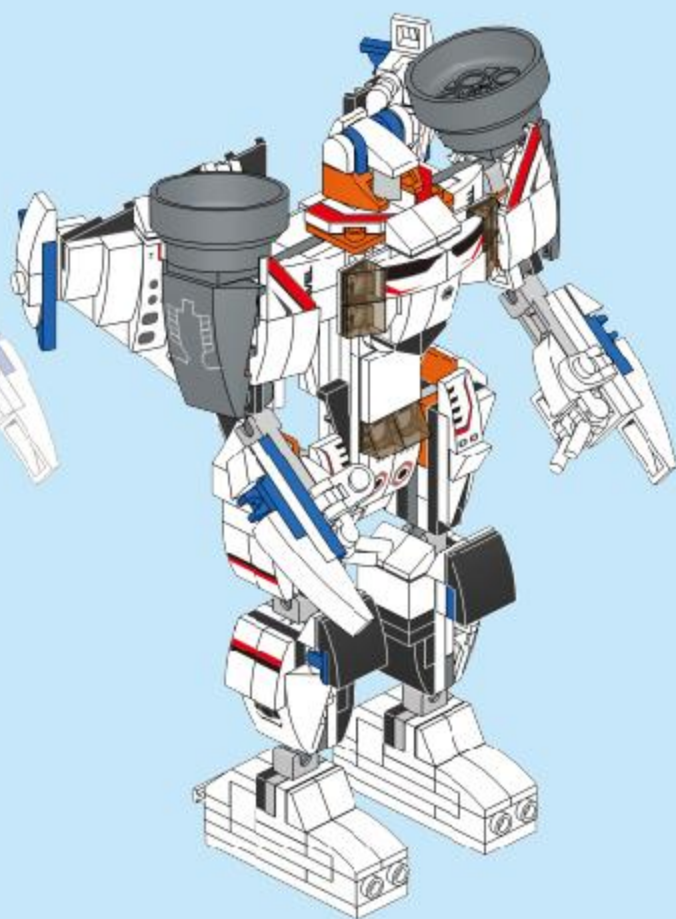
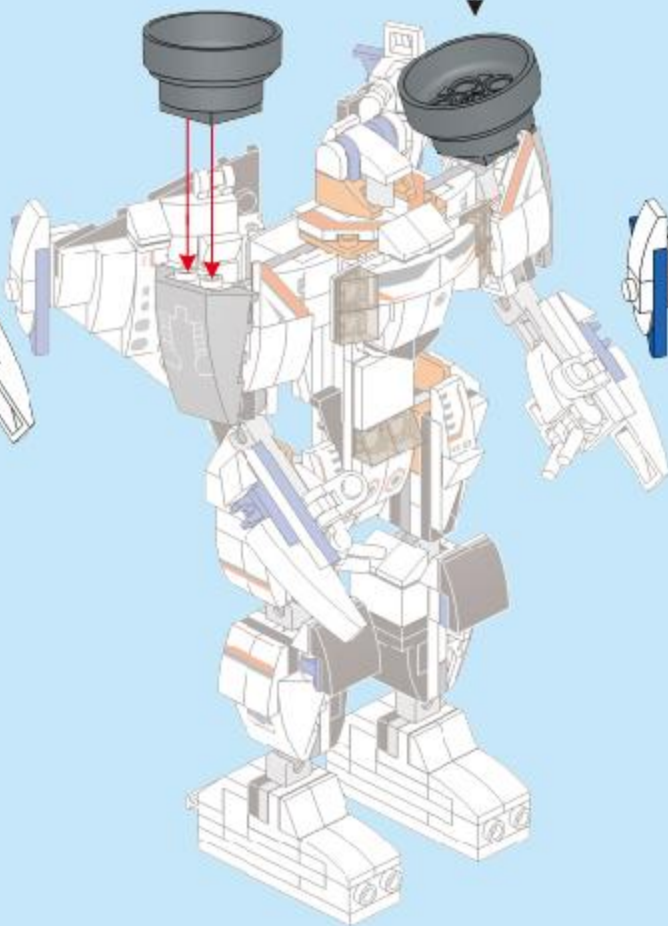
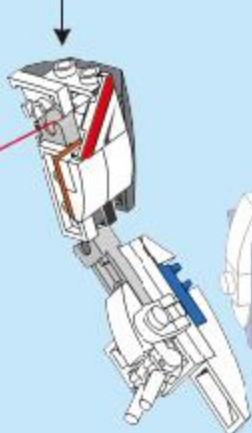
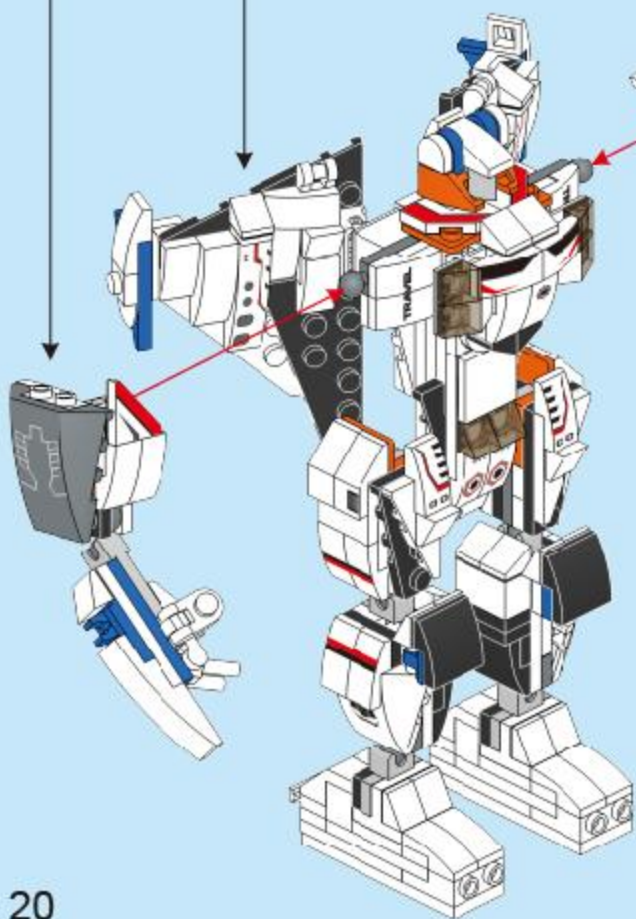

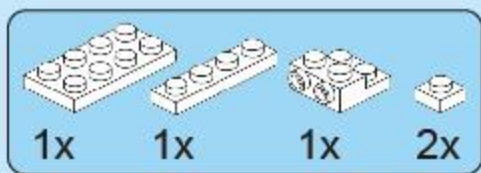

C1

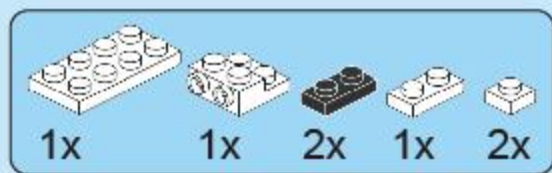

C2

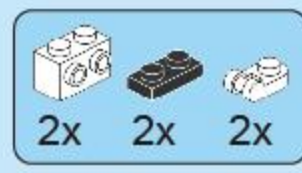

C3

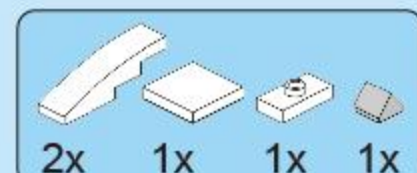

C4

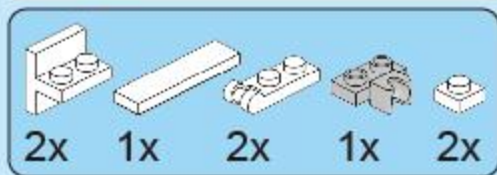
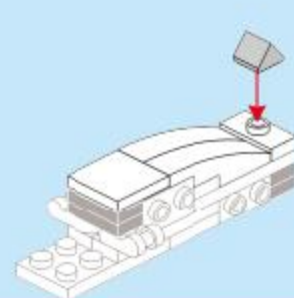
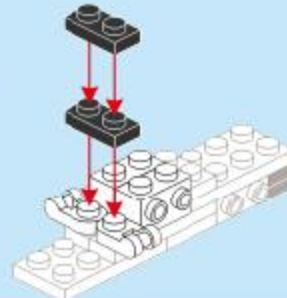
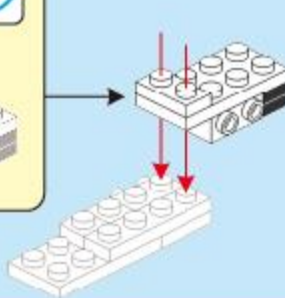
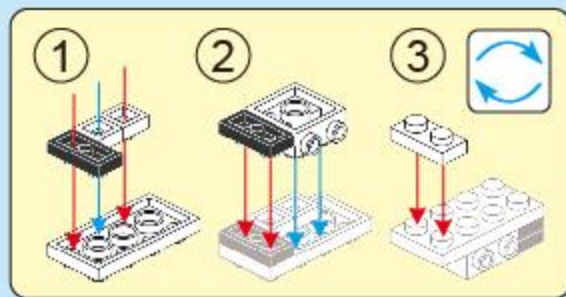
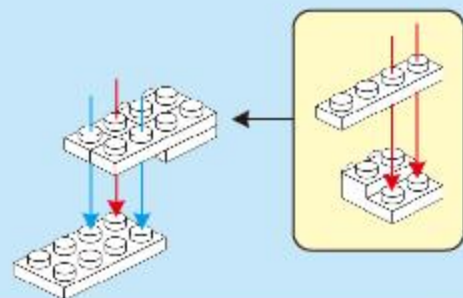

C5

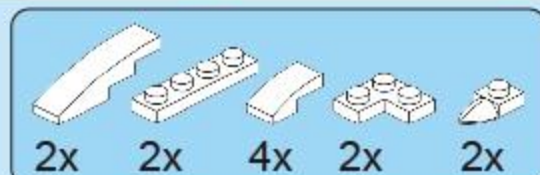

C6

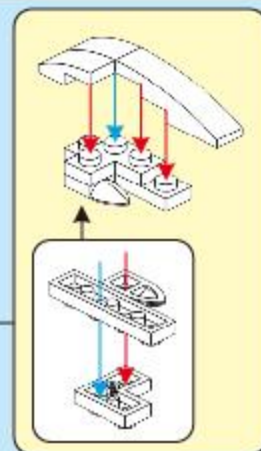
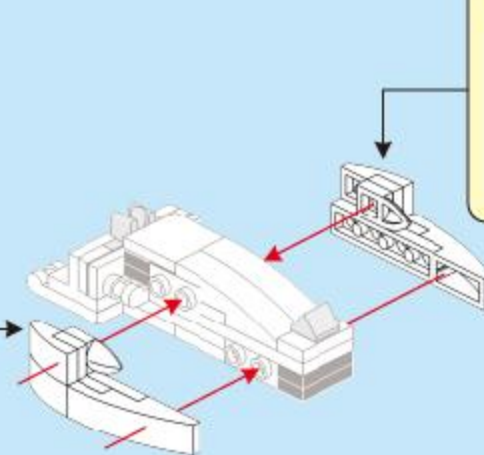
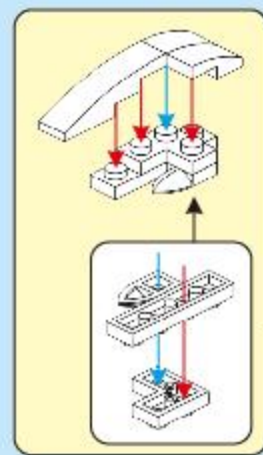
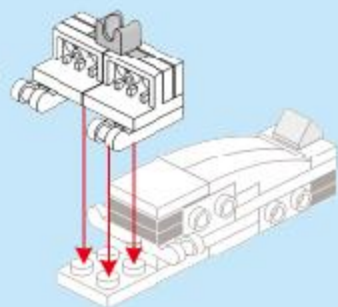
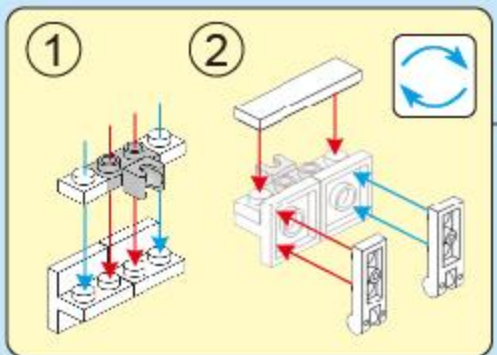

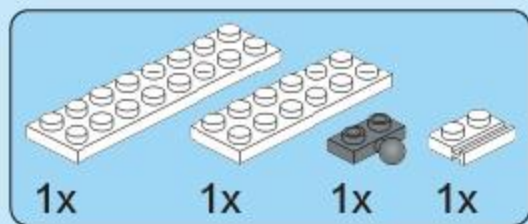

C7

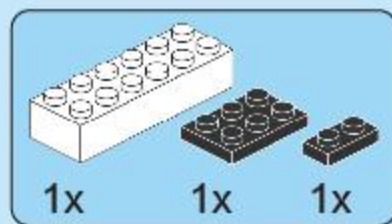
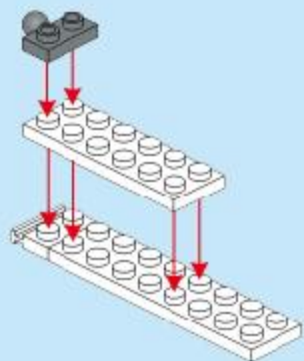

C8

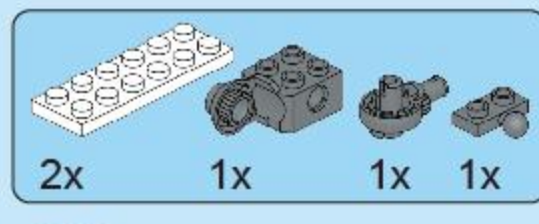
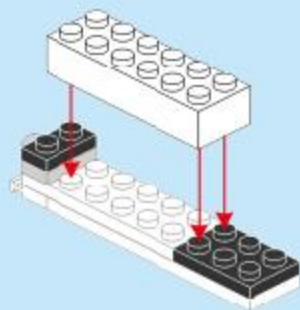

C9

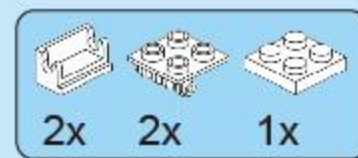
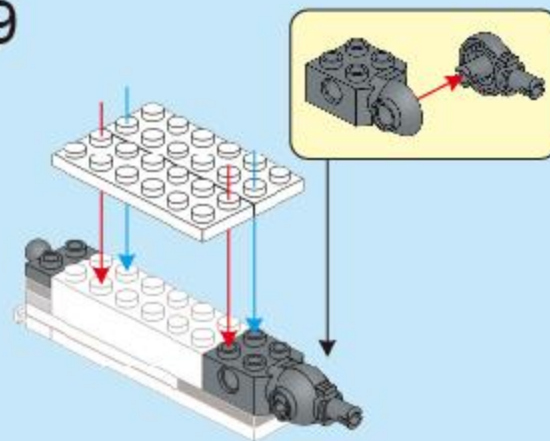

C10

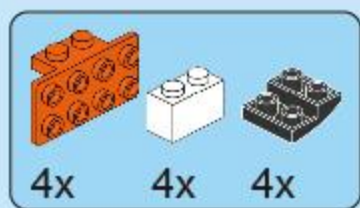
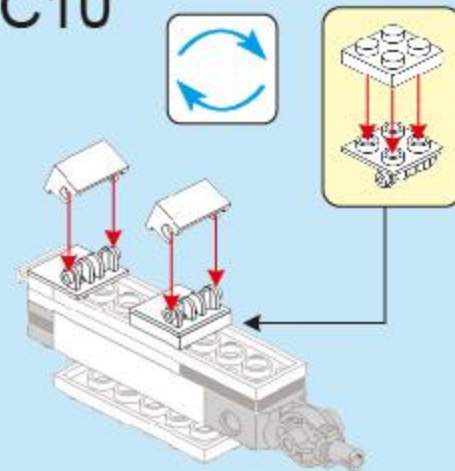

C11

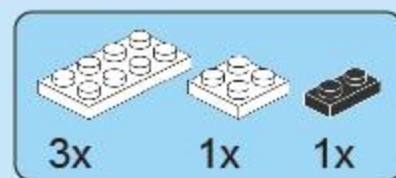
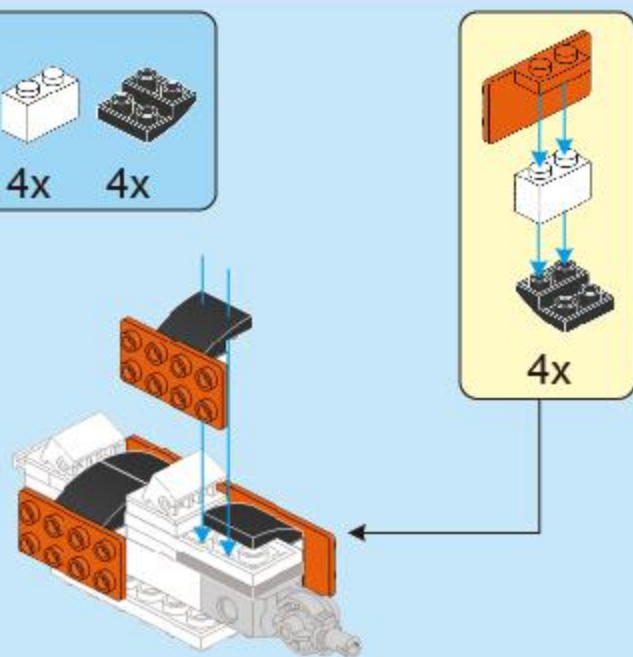

C12

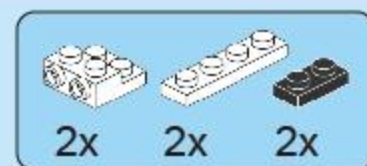
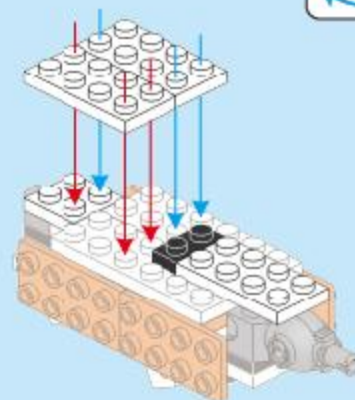

C13

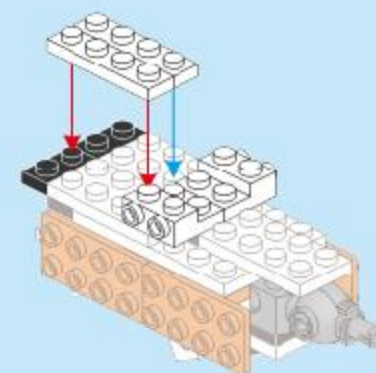

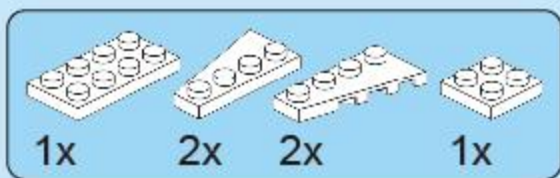

C14

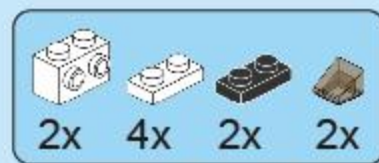
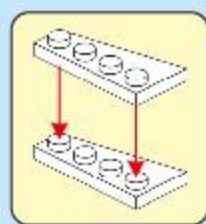
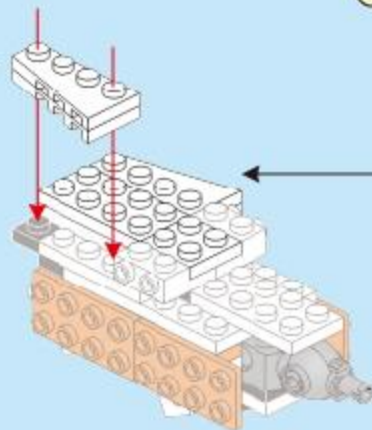
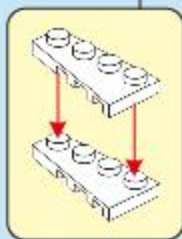

C15

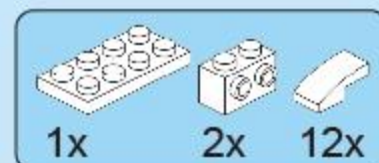
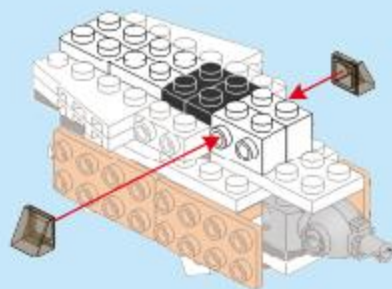

C16

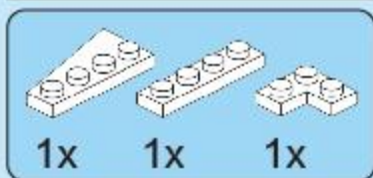
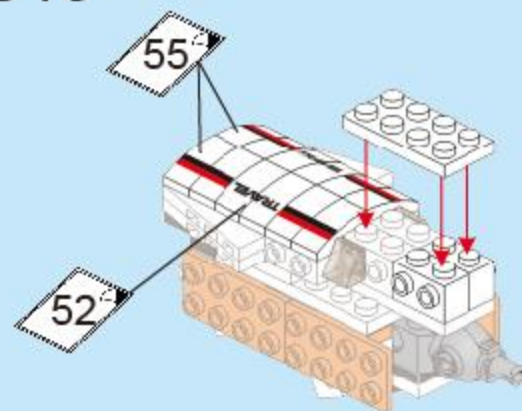

C17

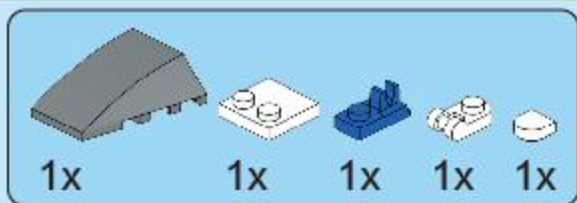
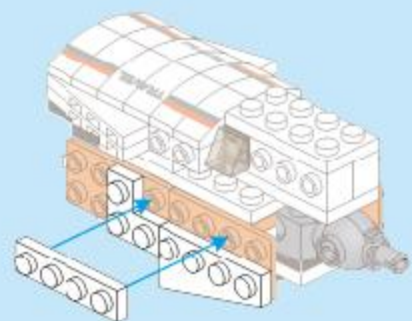

C18

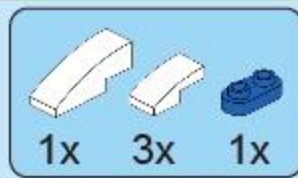
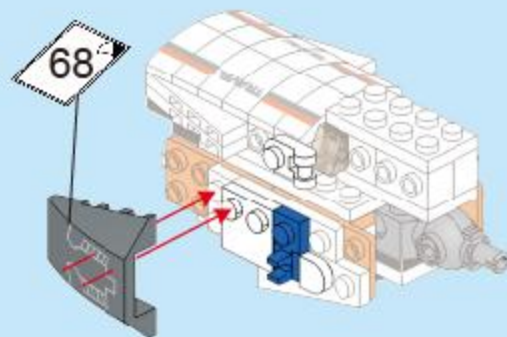

C19

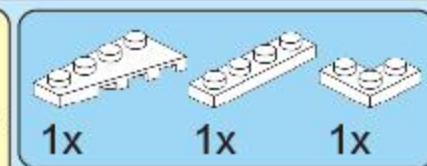
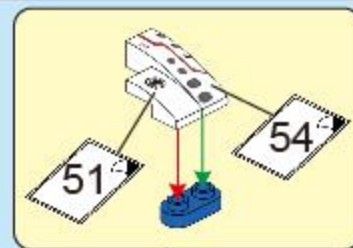
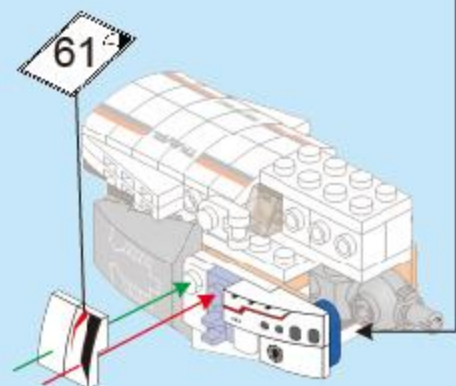

C20

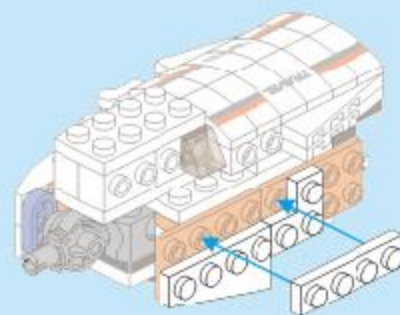

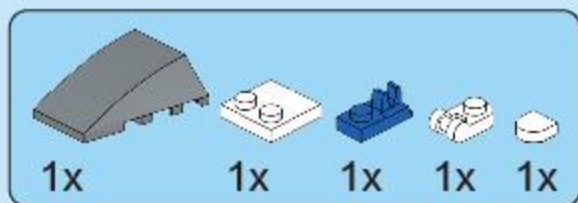

C21

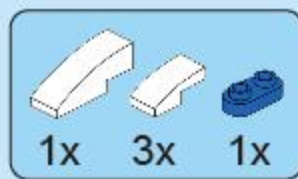
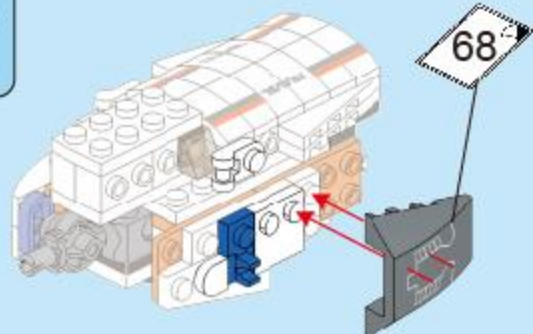

C22

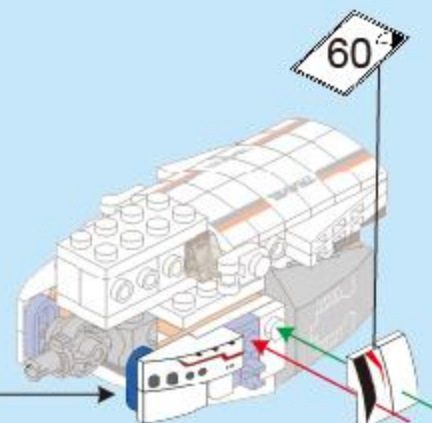
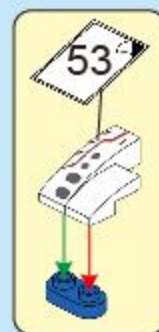

C23

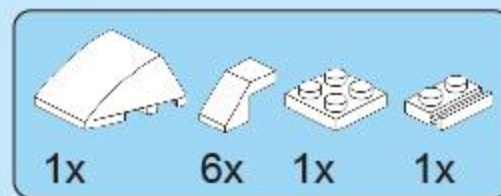
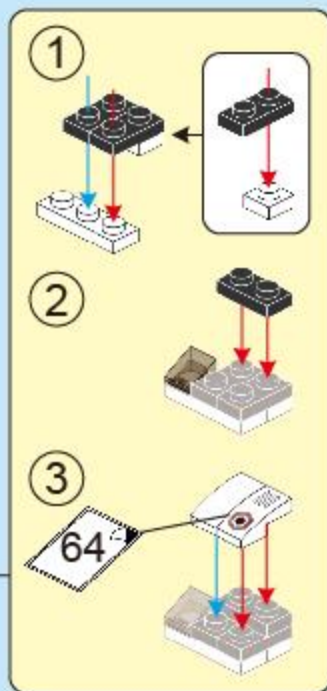
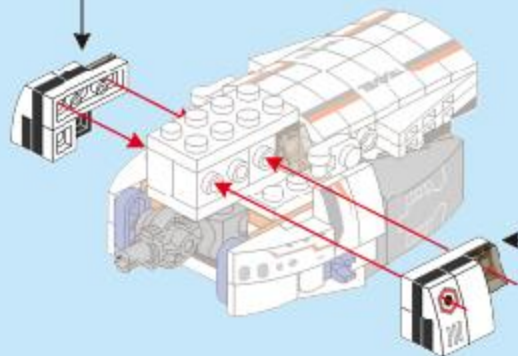
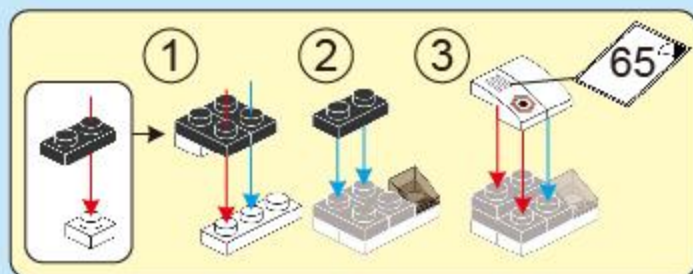

C24

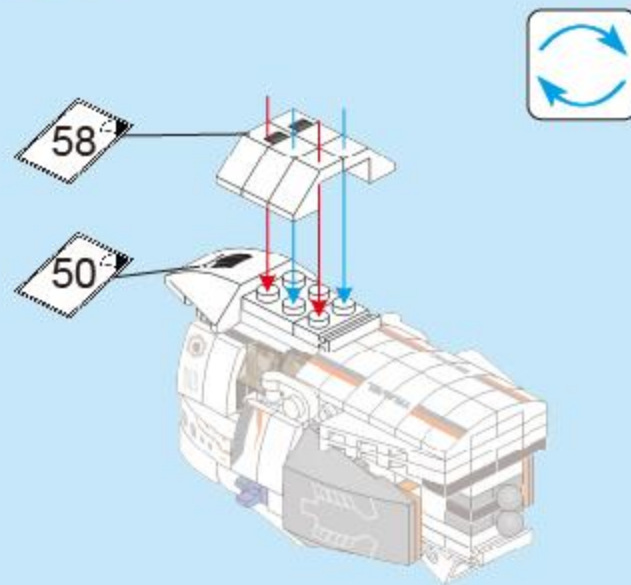

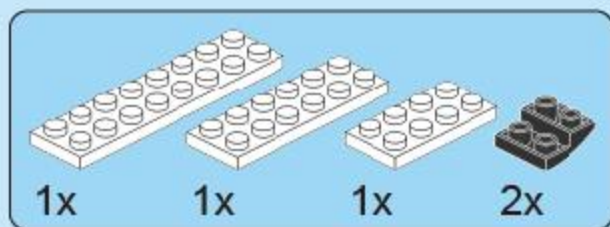

C25

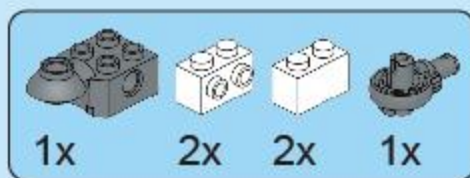
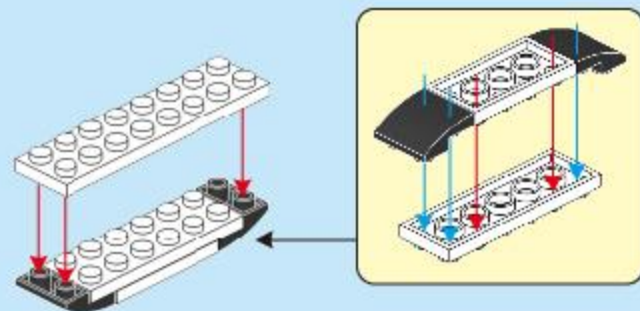

C26

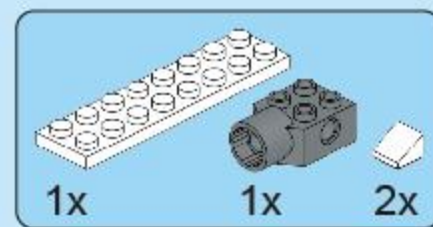
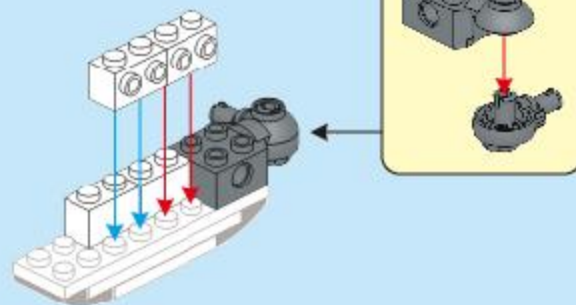

C27

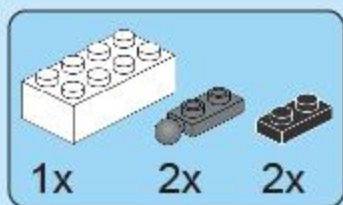
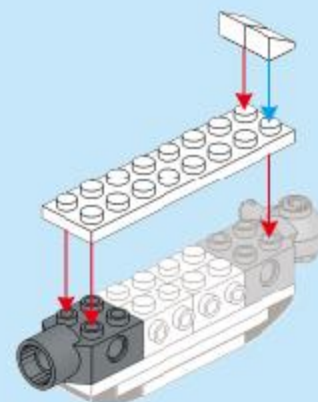

C28

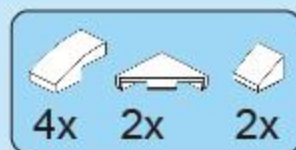
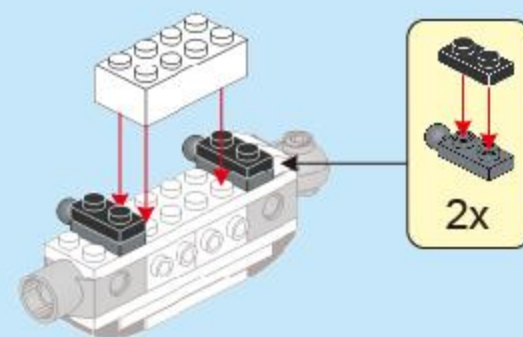

C29

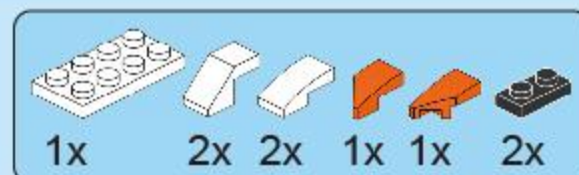
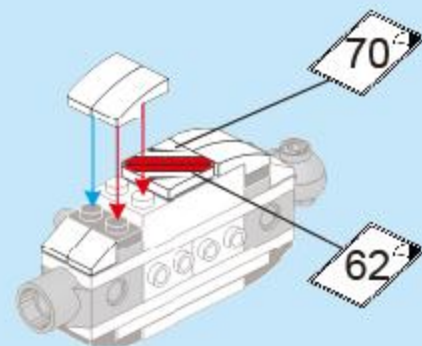

C30

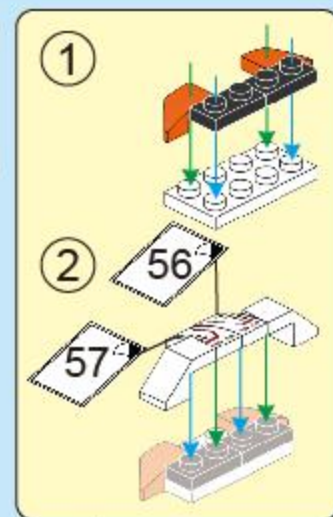
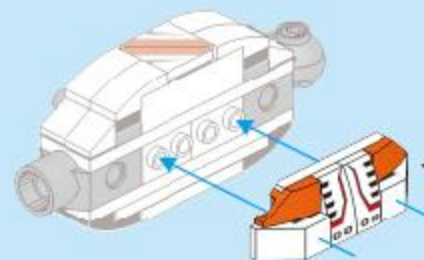

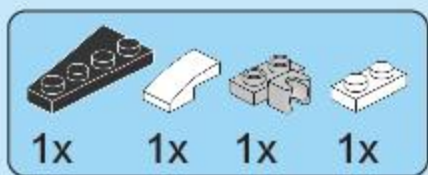

C31

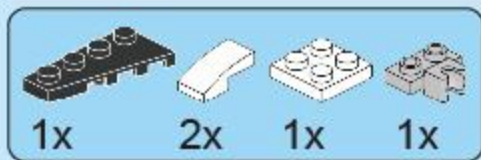
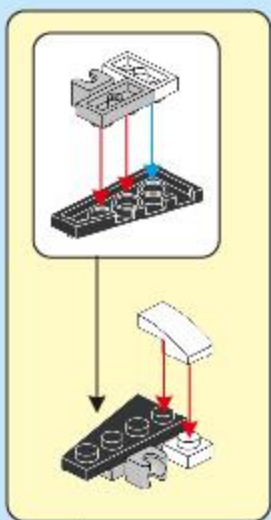

C32

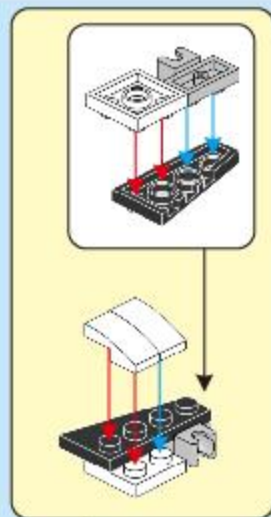
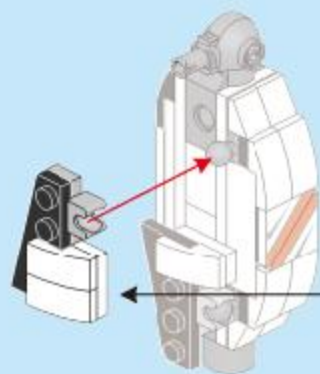

C33

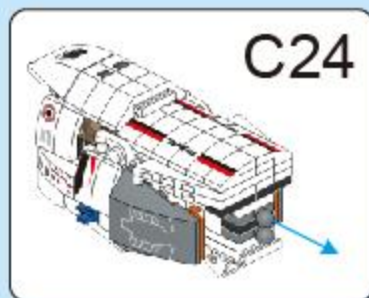

C24

C32



C24

C6

C

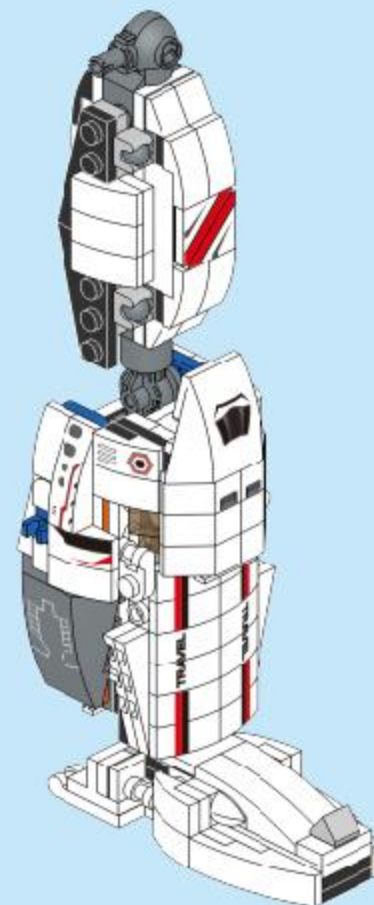
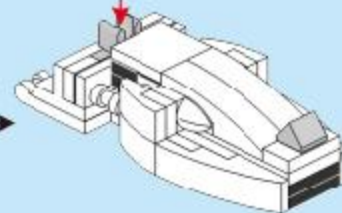
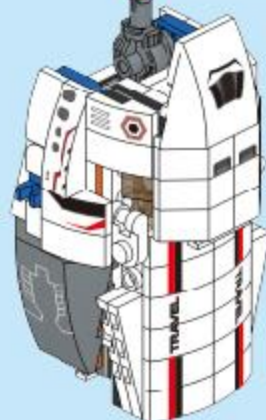

FC1033C
(C56)



FC1033C
(C61)



FC1035C



FC1031C

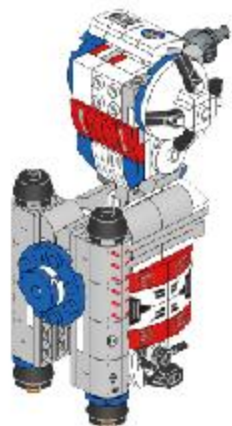

FC1032C



FC1033C
(C48)



FC1034C

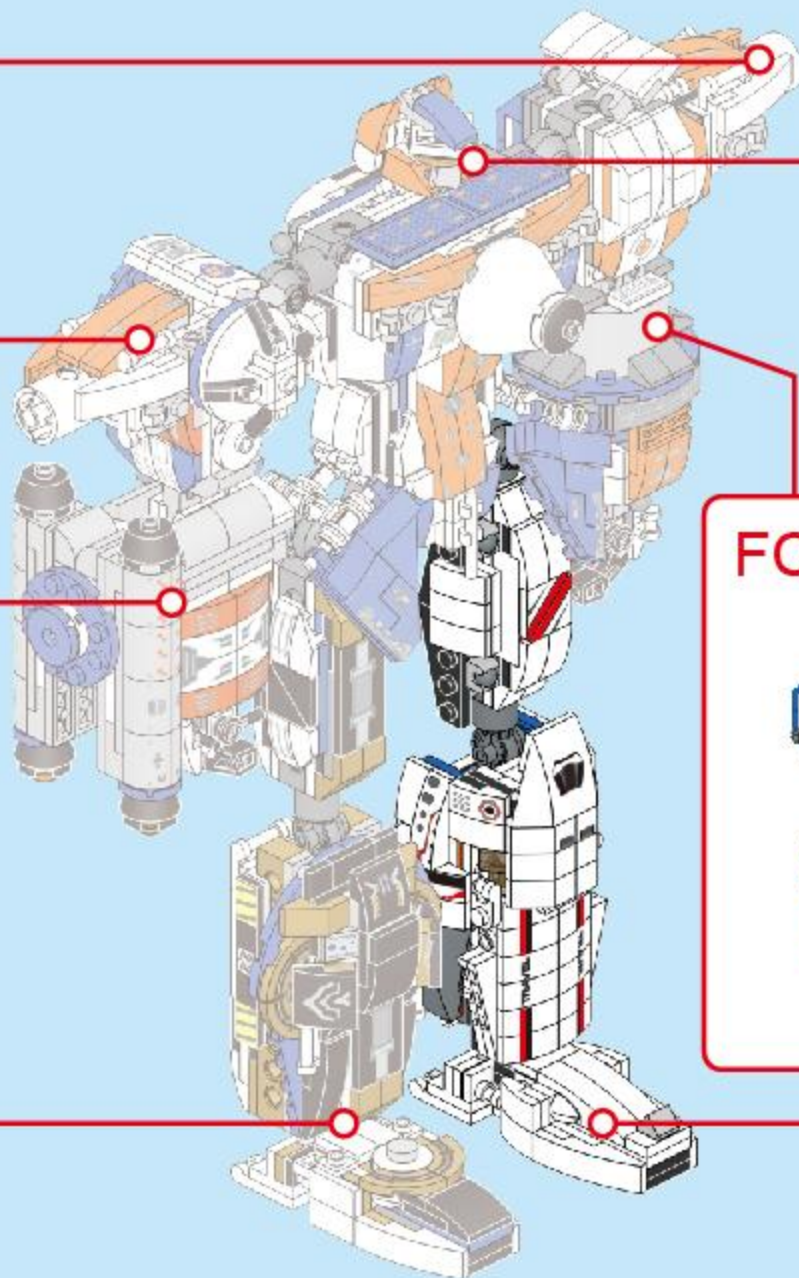
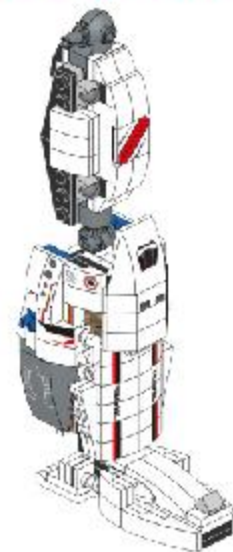



2 IN 1
TRANSFORMS



5 COLLECT 5 MODELS
TO COMBINE GOD OF WAR ODIN