

FC1035



COLLECT 5 MODELS
TO COMBINE GOD OF WAR ODIN

拆件器使用方法，仅为示例

Usage of Brick Separator, Just for the sample

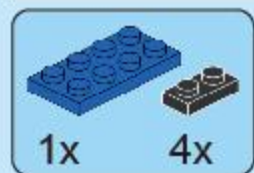
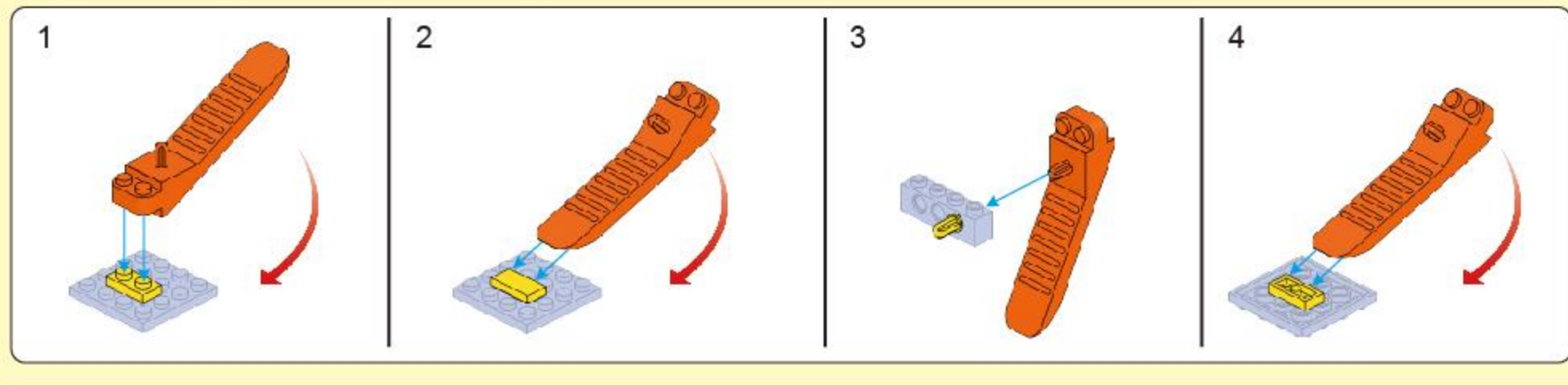

A1



A2

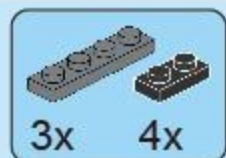

A3

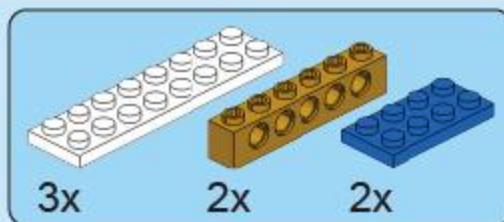

A4

2

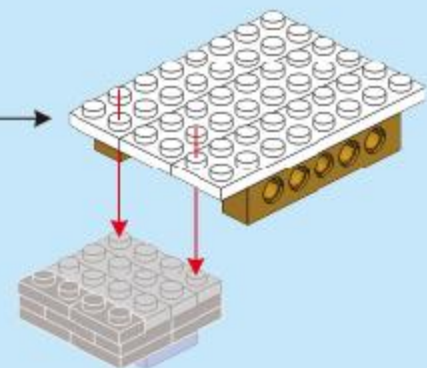
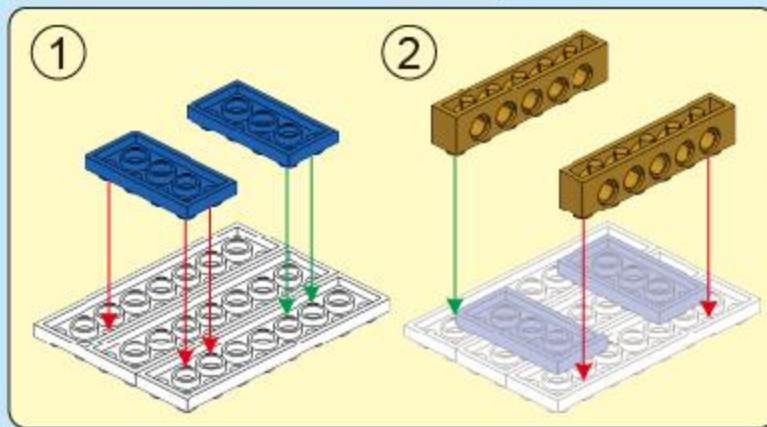
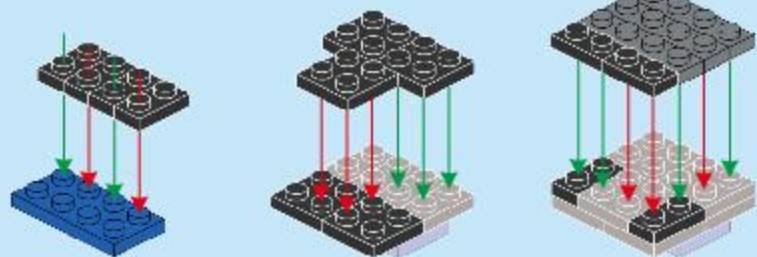

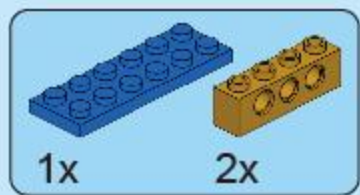

A5

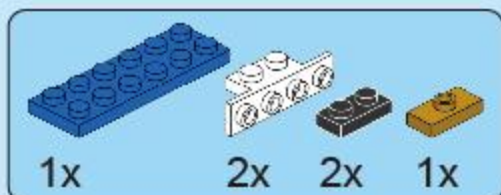
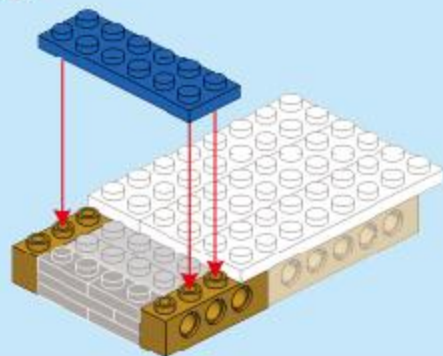

A6

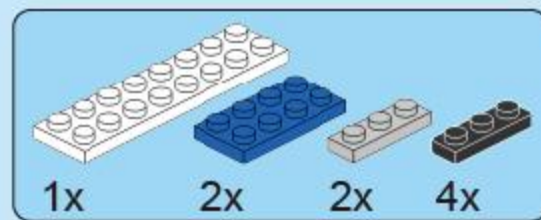
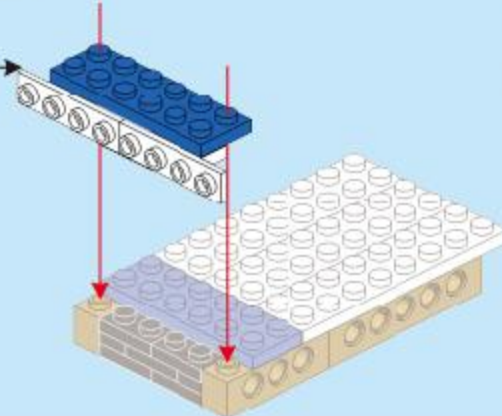
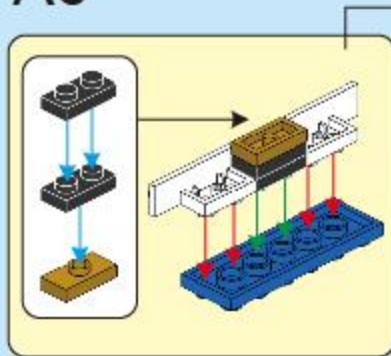

A7

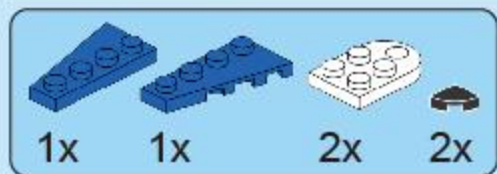
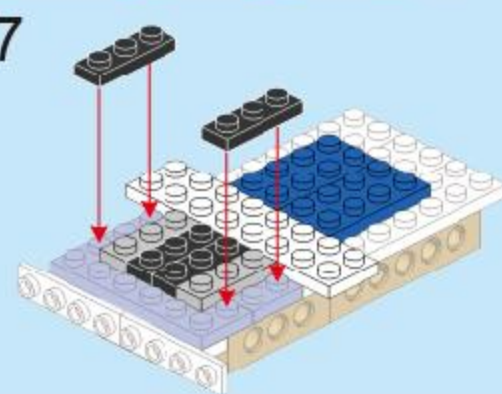

A8

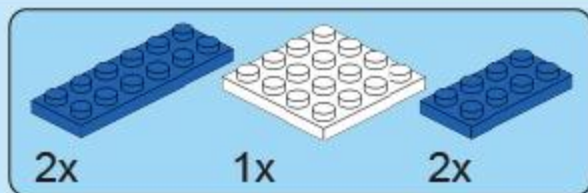
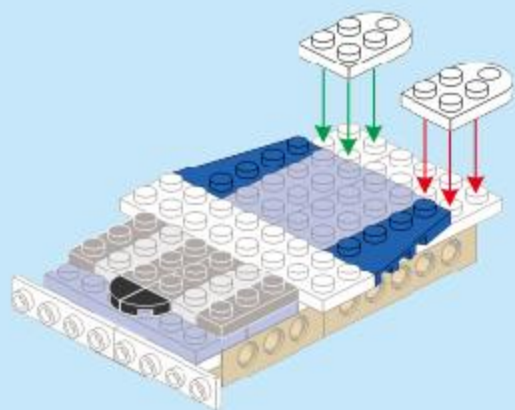

A9

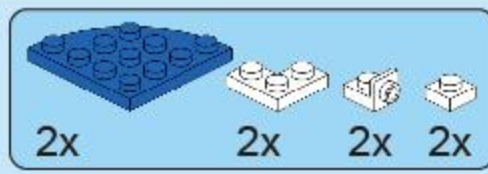
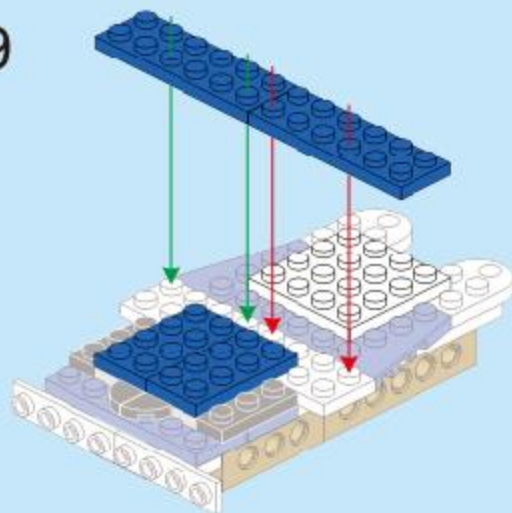

A10

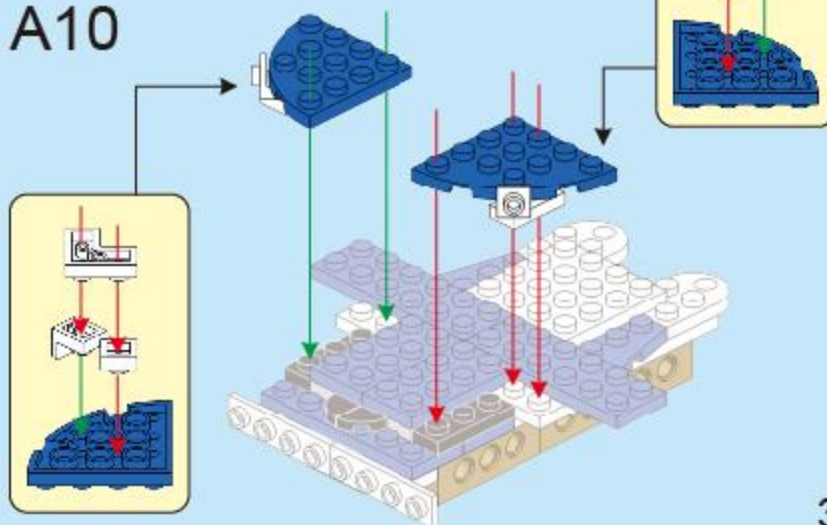

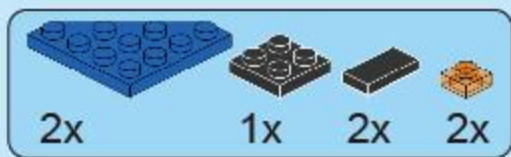

A11

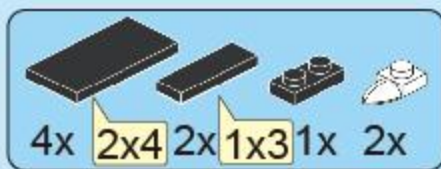
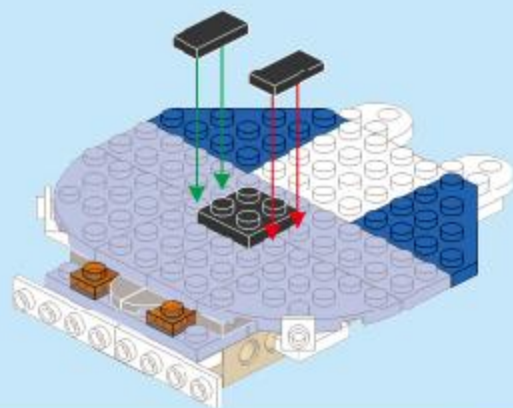

A12

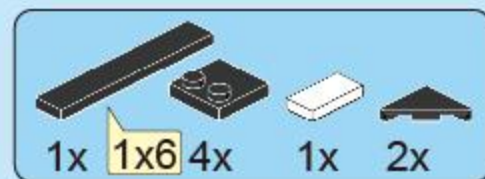
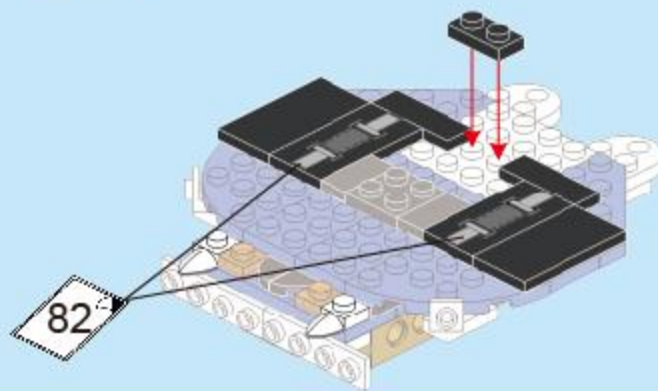

A13

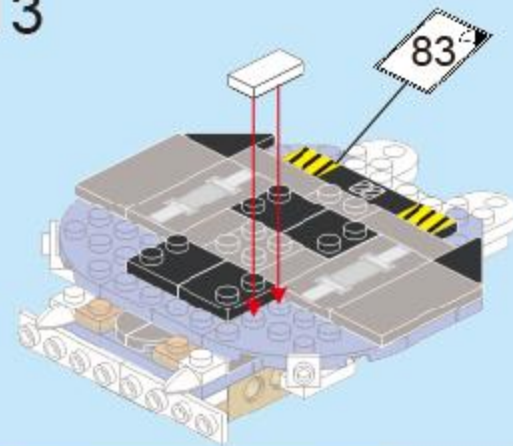

A14

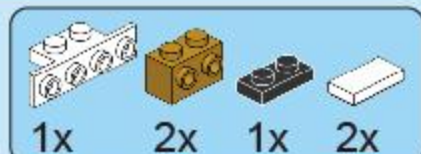
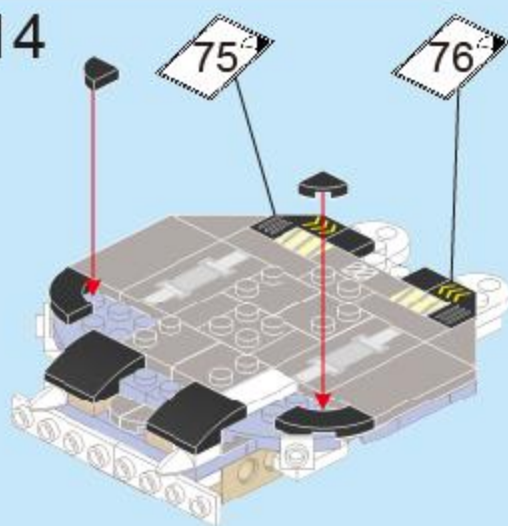

A15

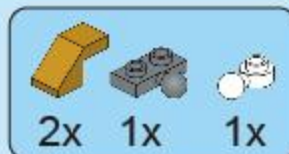
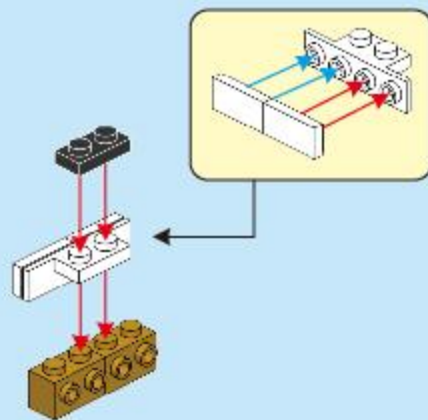

A16

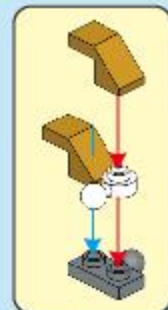
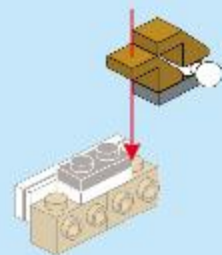

A17

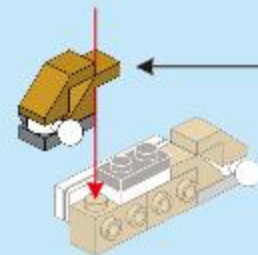

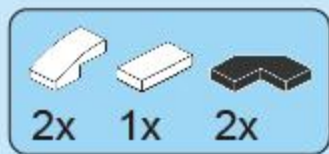

A18

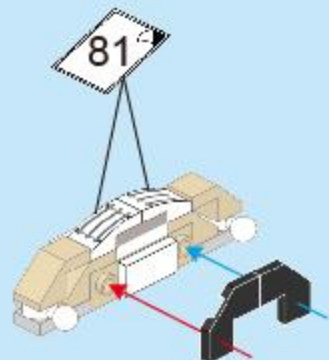

A19

A18

A14

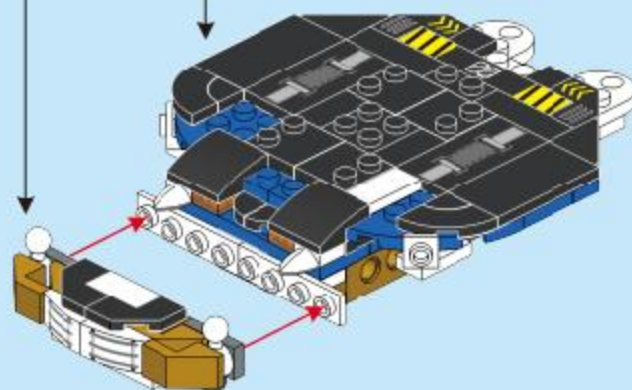

A20

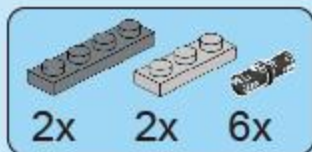
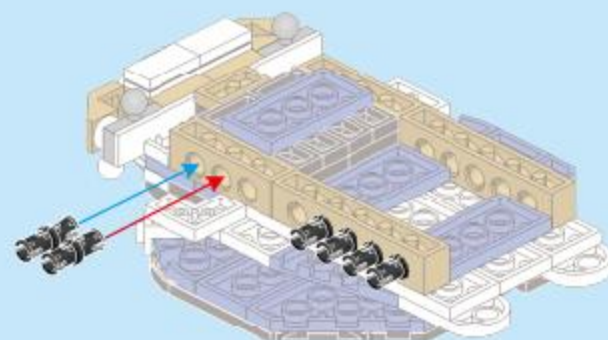

A21

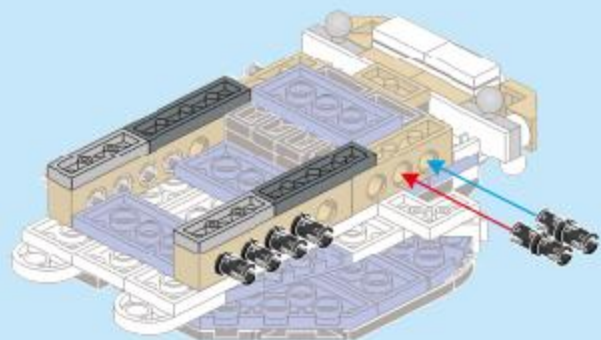

A22

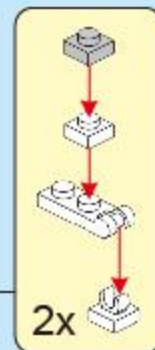
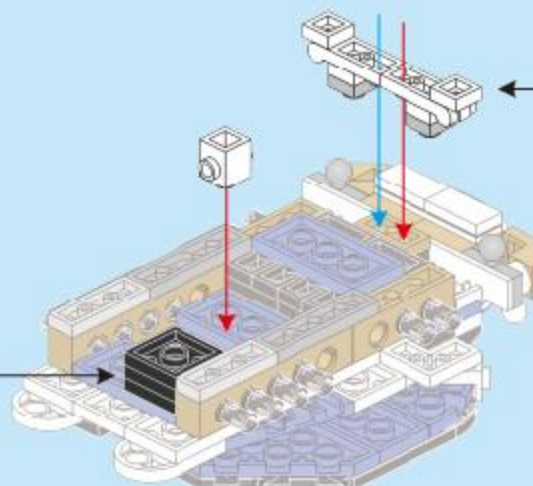
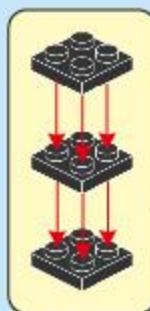

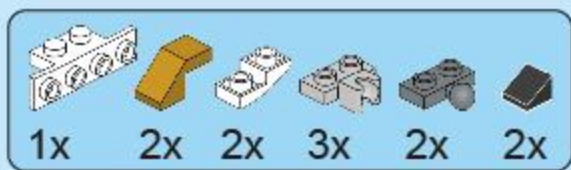

A23

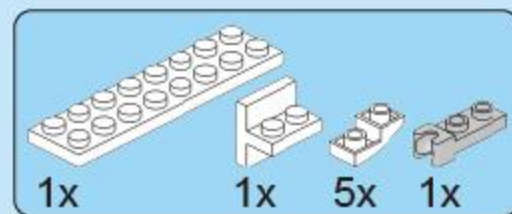
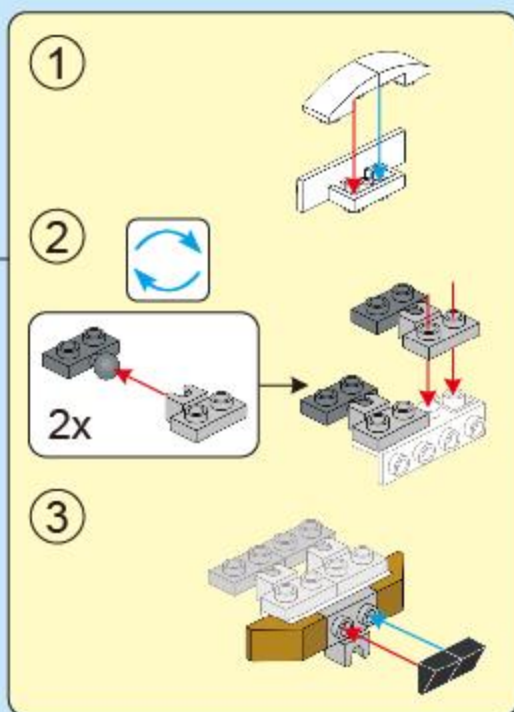
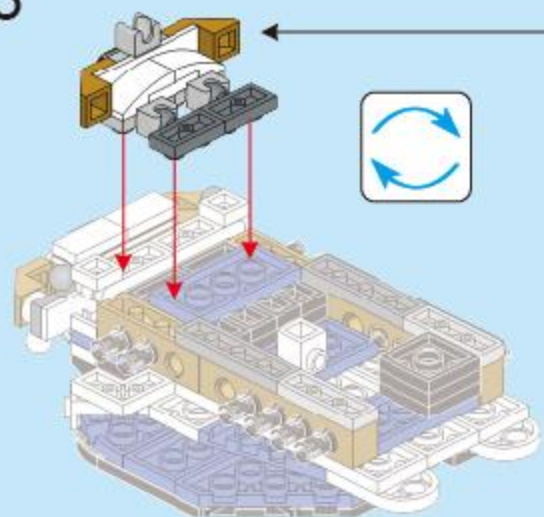

A24

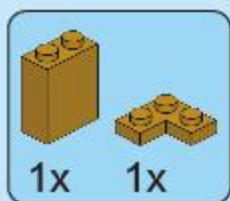
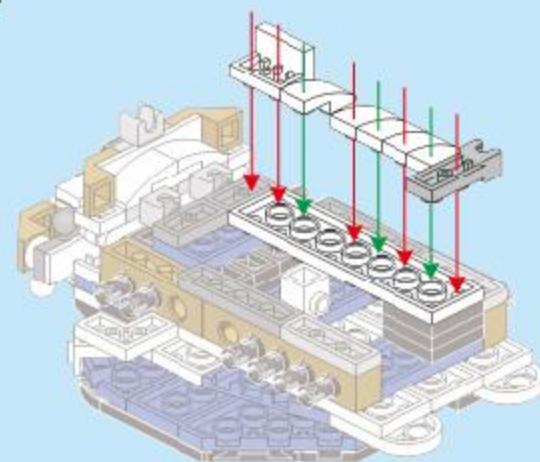

A25

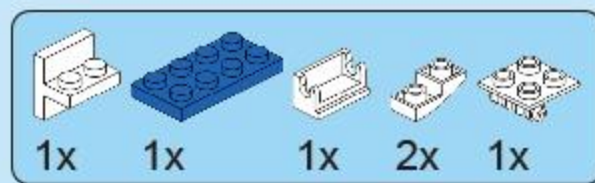
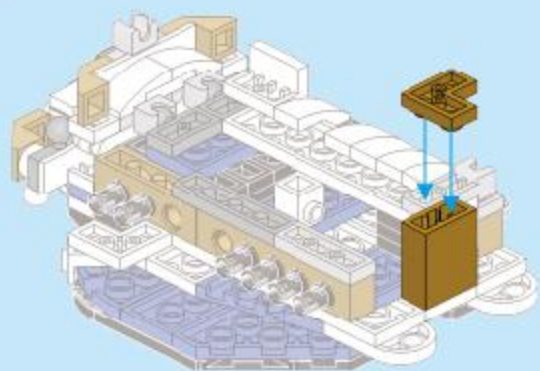

A26

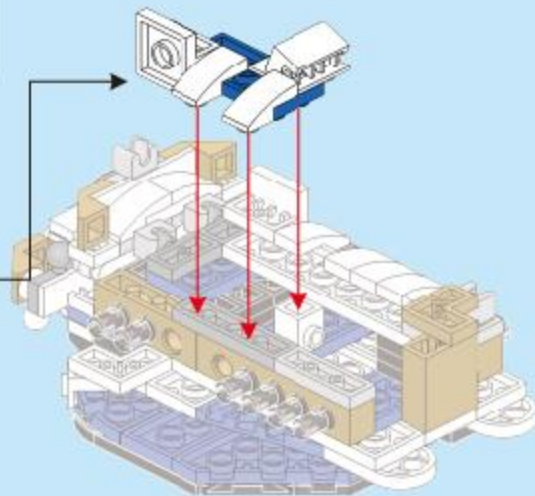
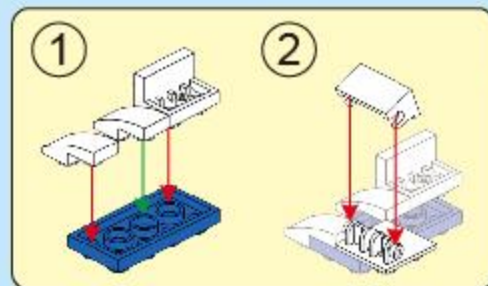

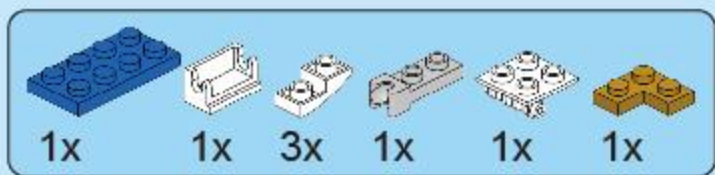

A27

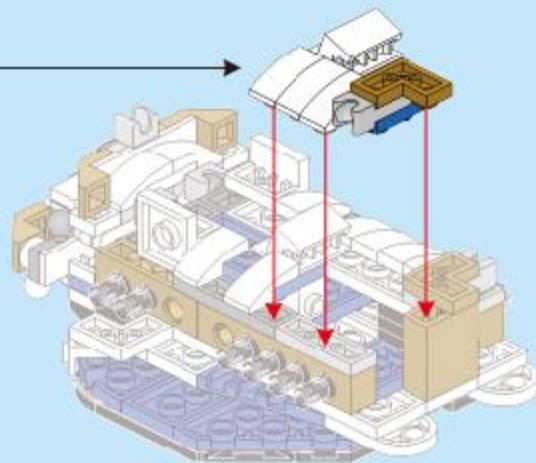
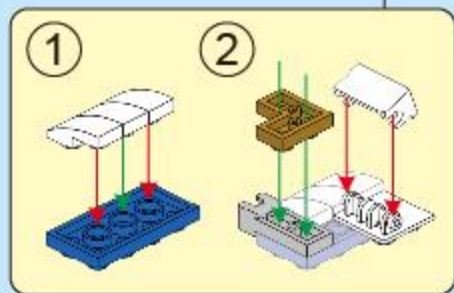

A28

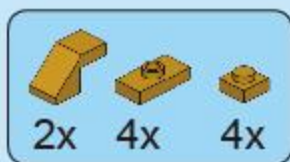
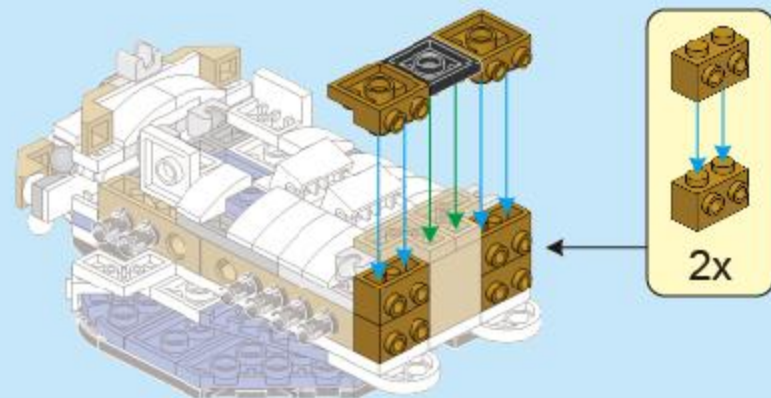

A29

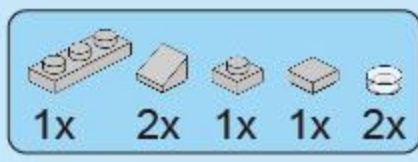
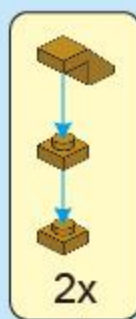
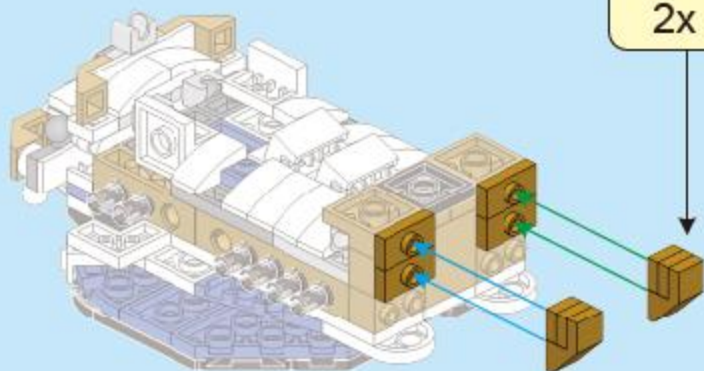

A30

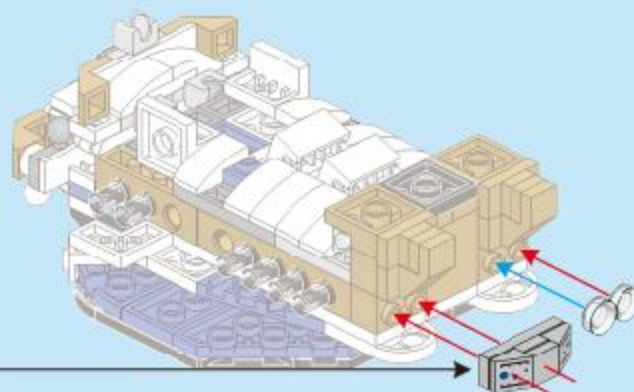
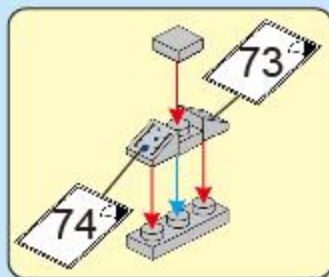

A31

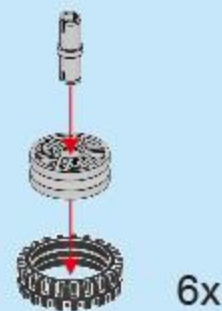



A32



3x



A33

A31

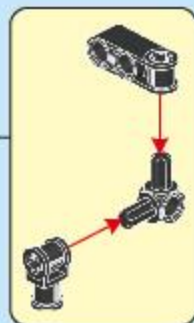

3x

A34

A30

A33

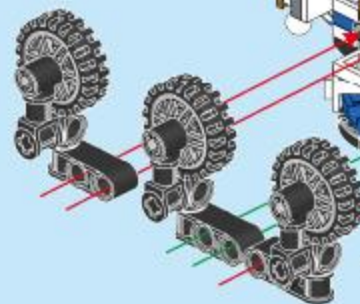

A32

A35

A34

A32

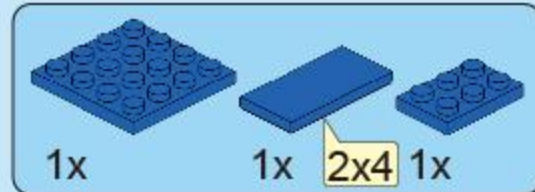

A36

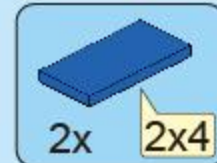

A37

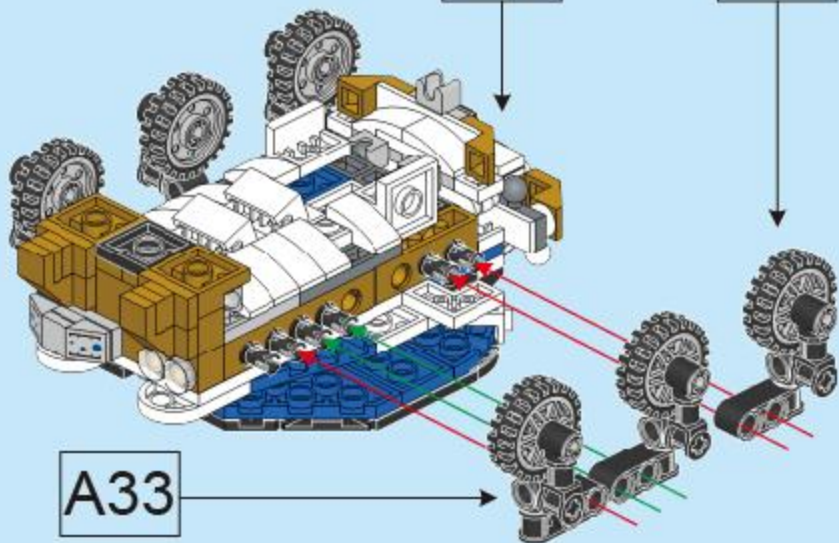

A33

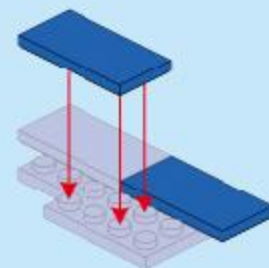
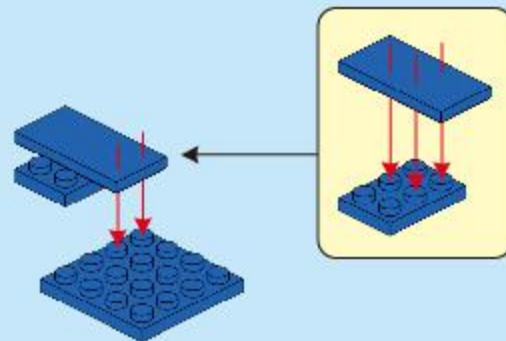



A38

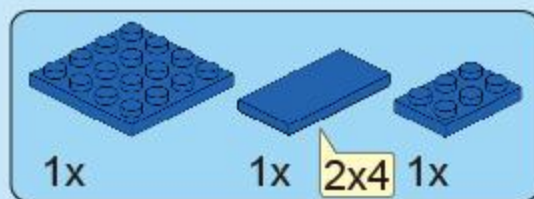
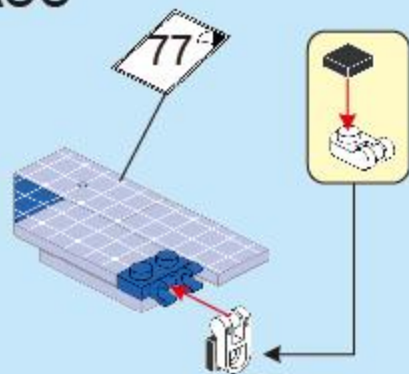

A39

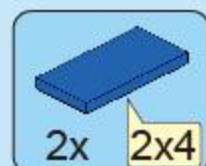
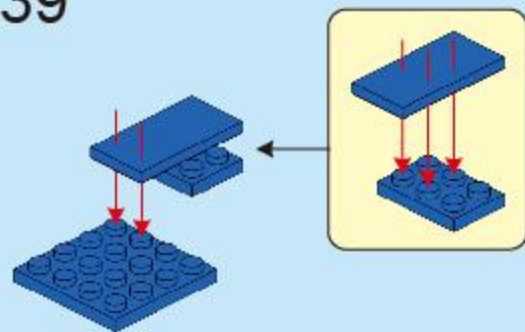

A40

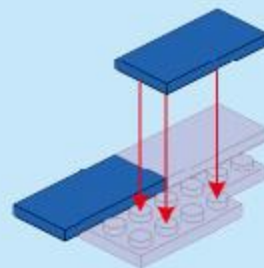

A41

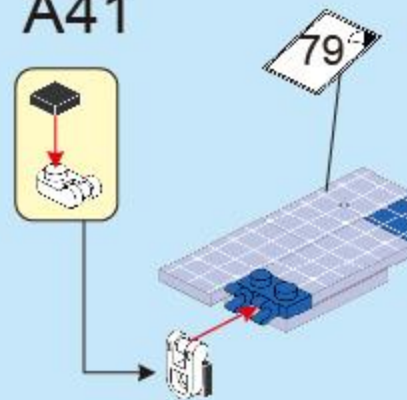

A42

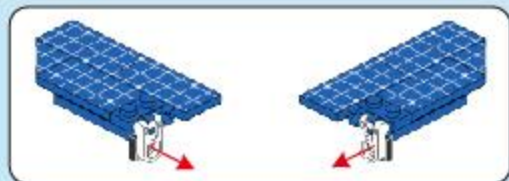

A41

A35



A38

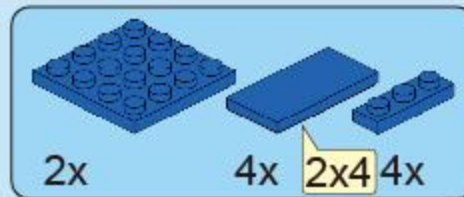
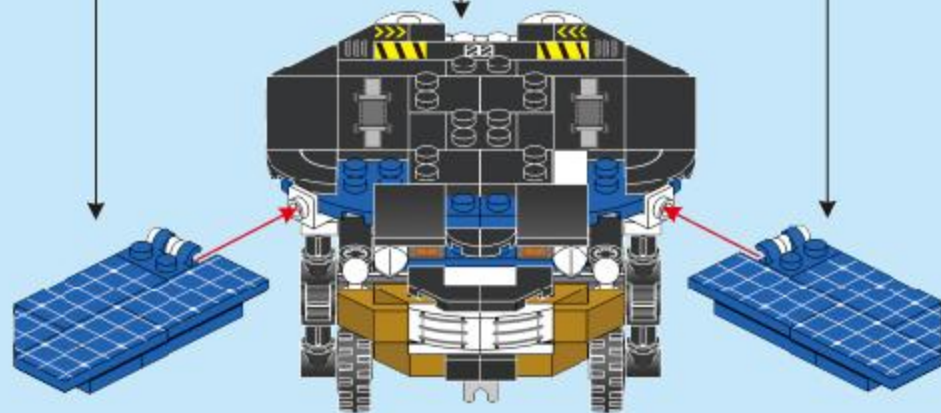

A43

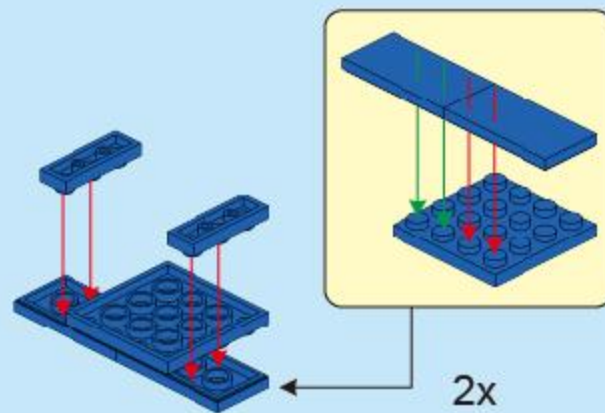

A44

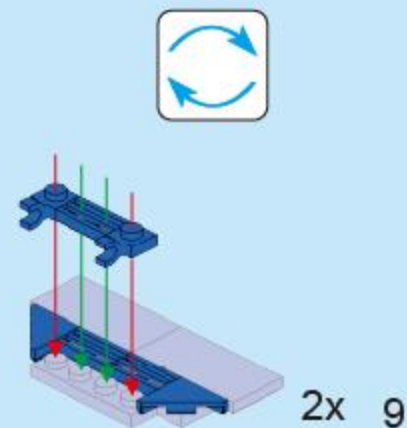

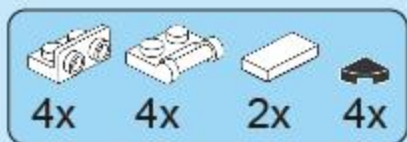

A45

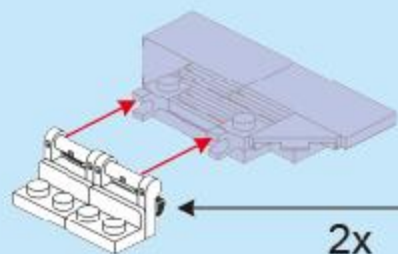

2x

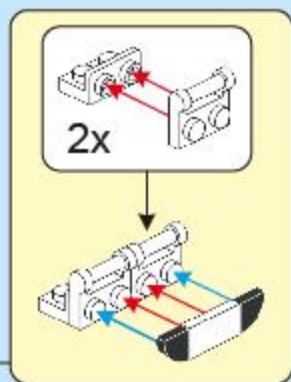

2x

A46

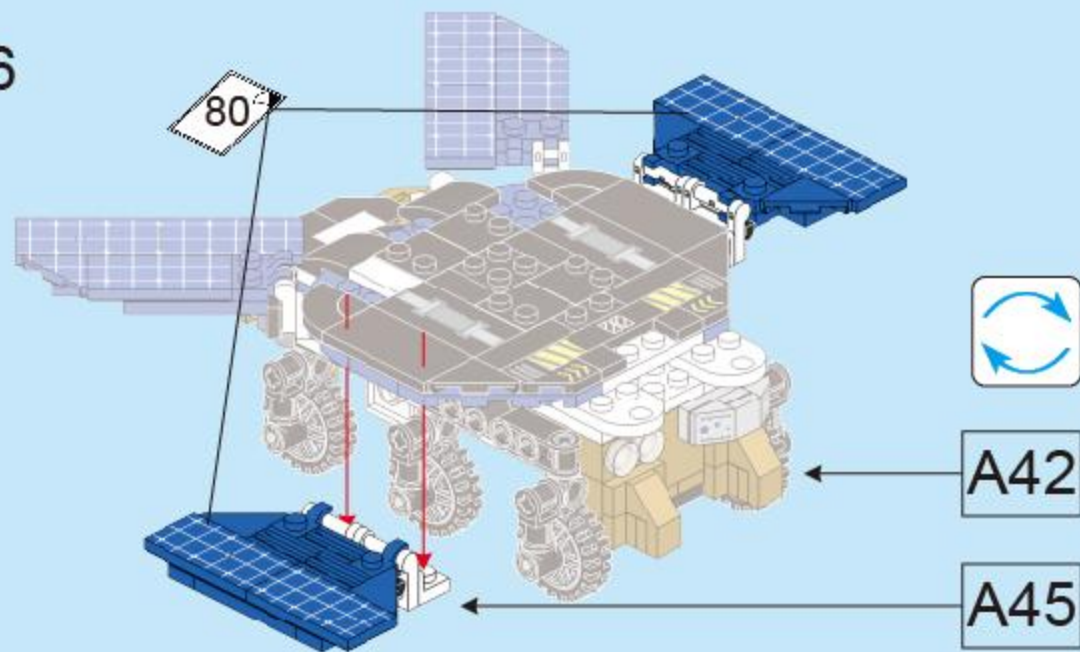

A42

A45



A47

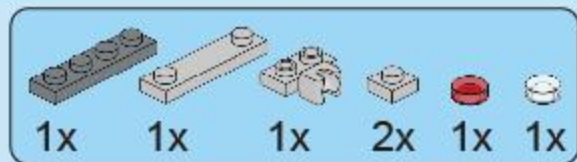
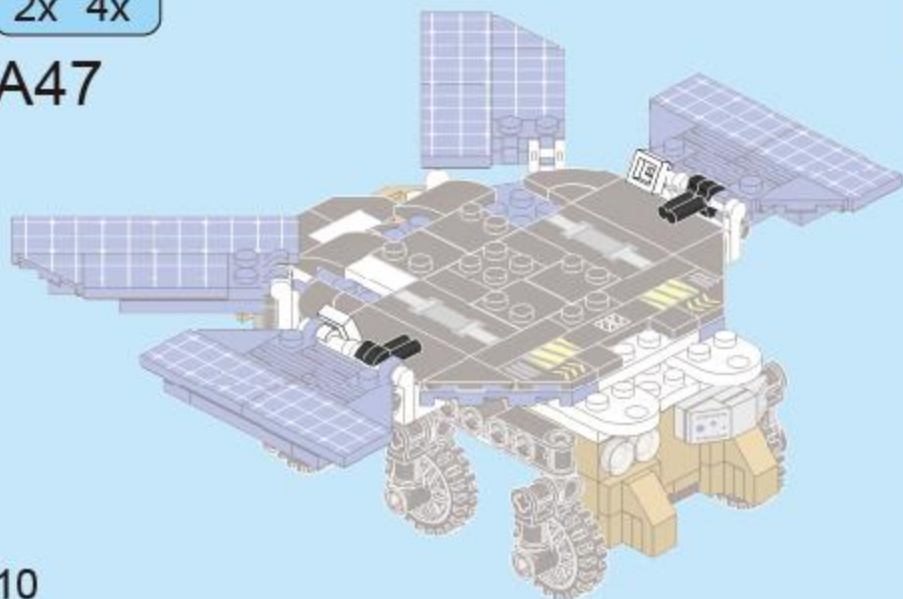

A48

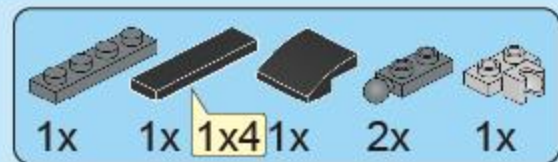
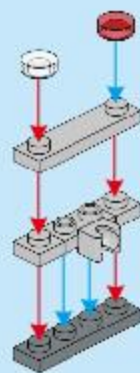

A49

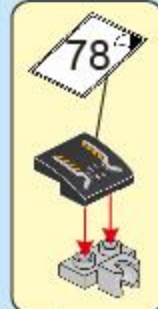
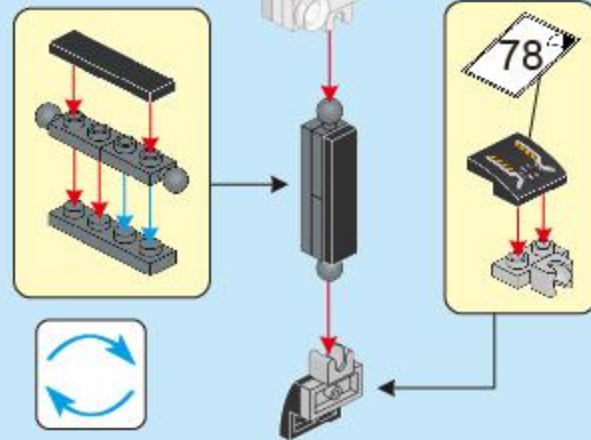

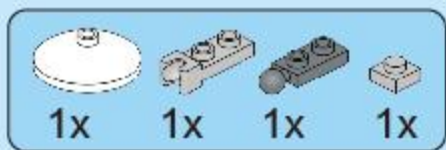

A50

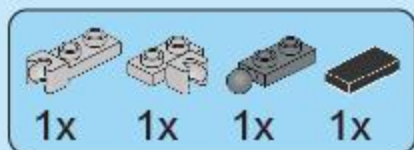

A51

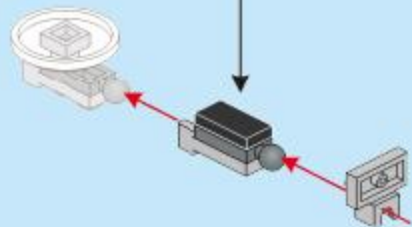
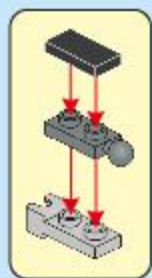
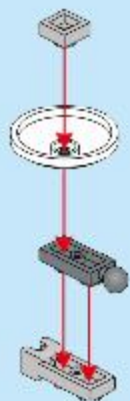

A52

A47

A51

A49

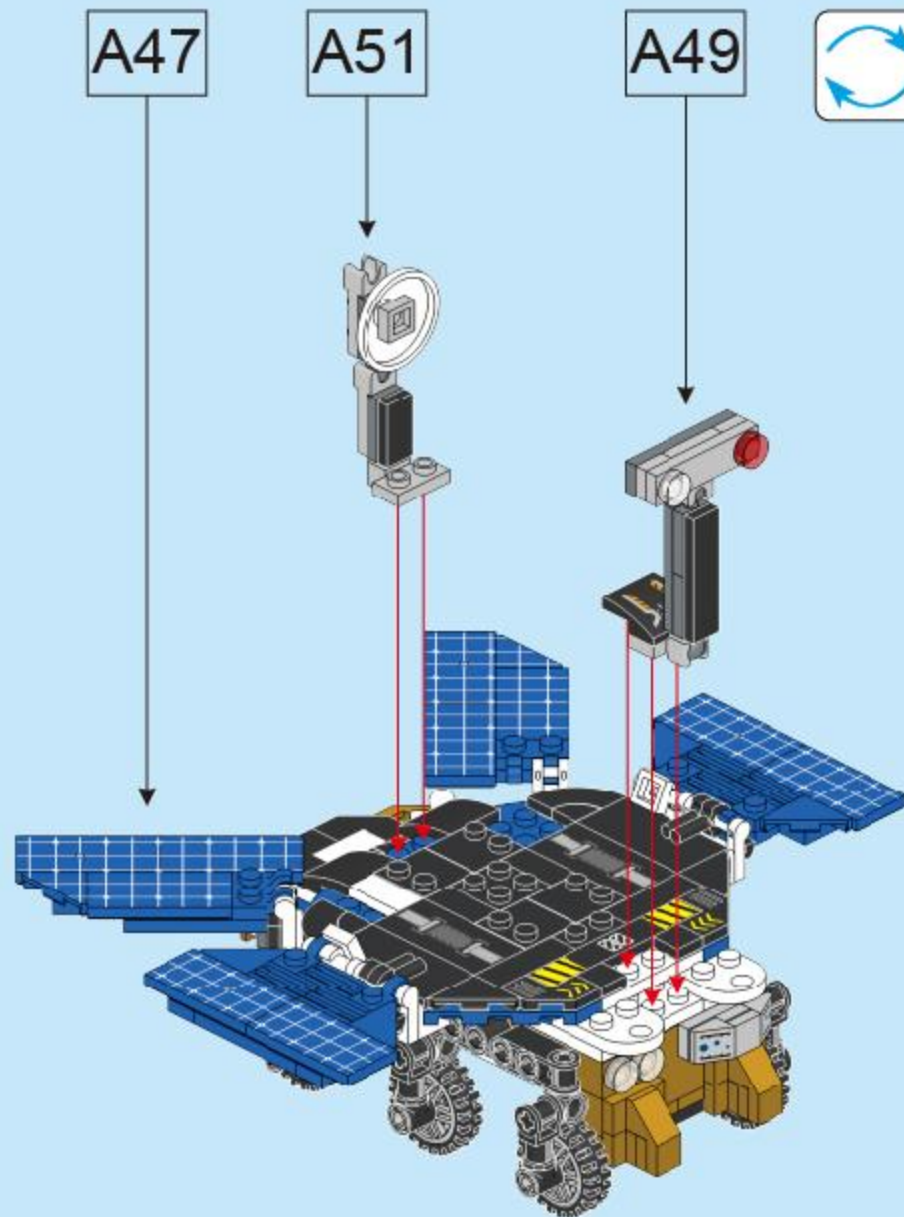



A53

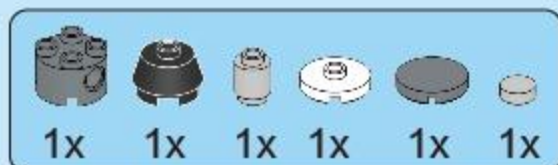
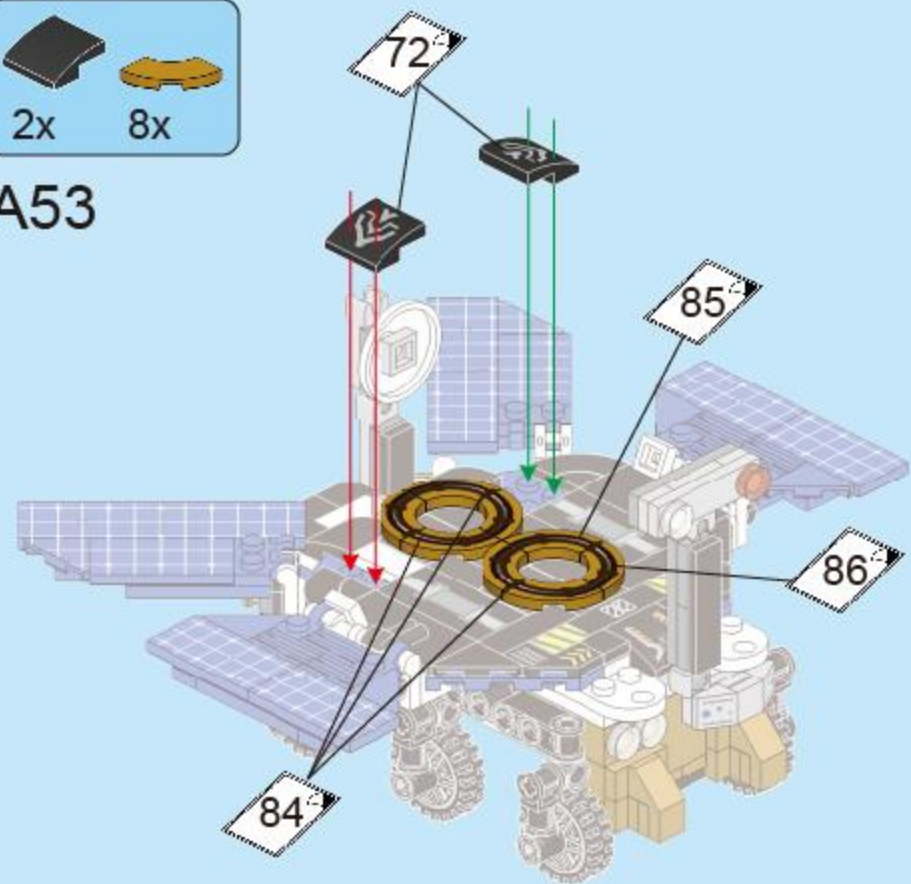

A54

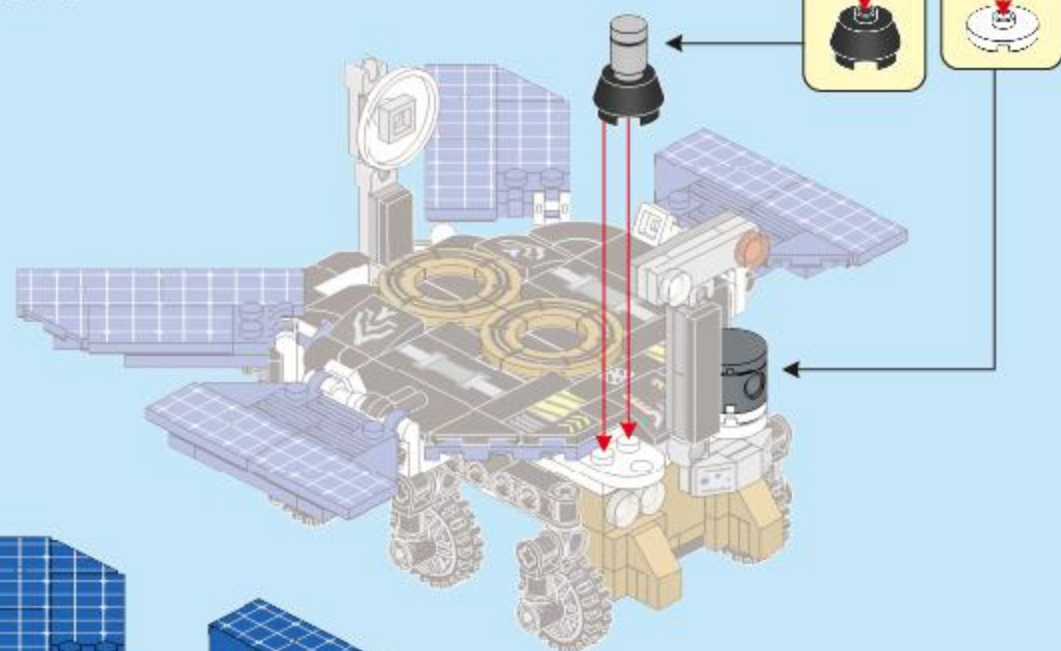

A

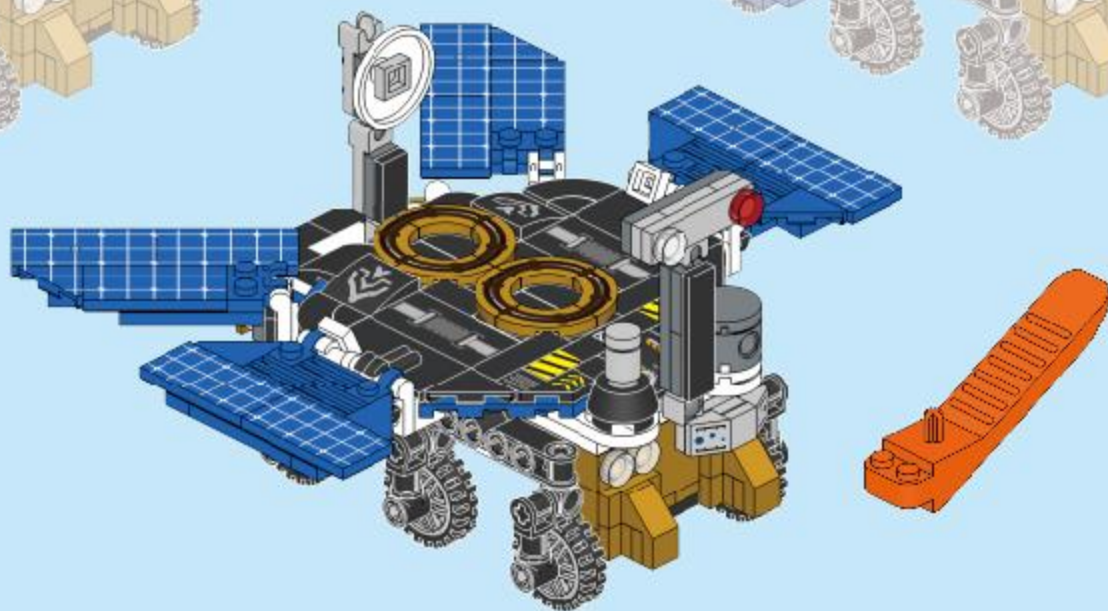

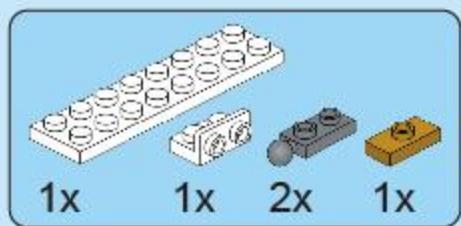

B1

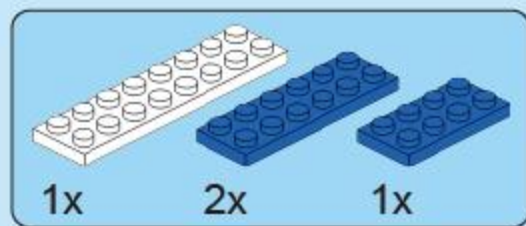
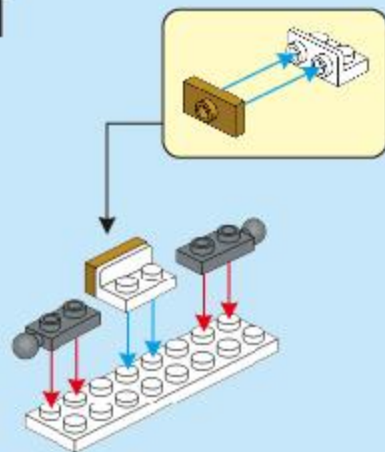

B2

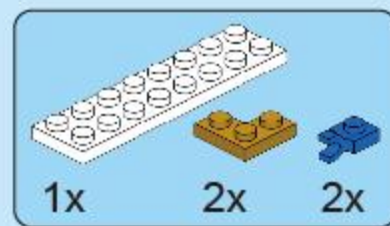
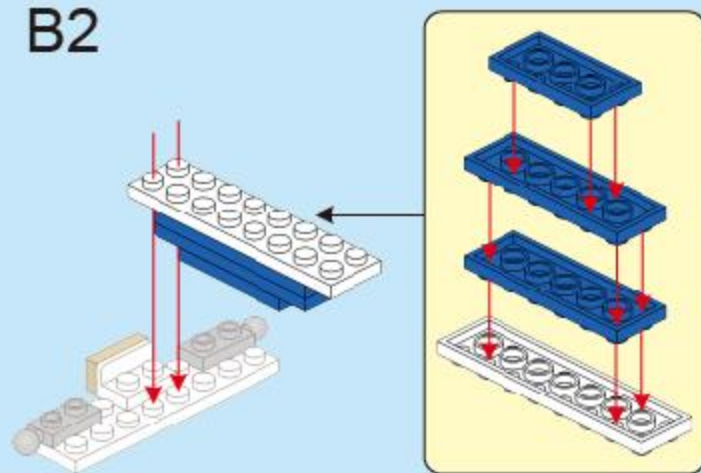

B3

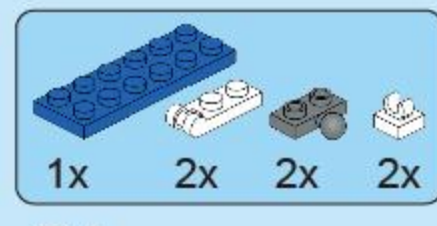

B4

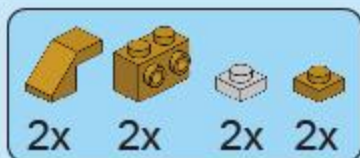
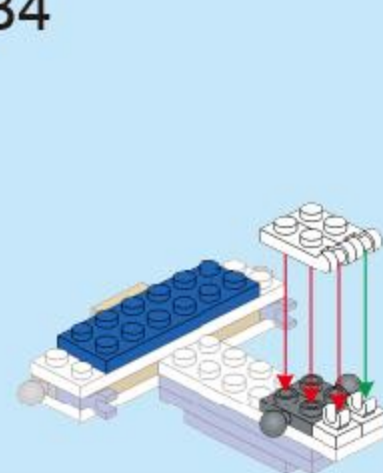

B5

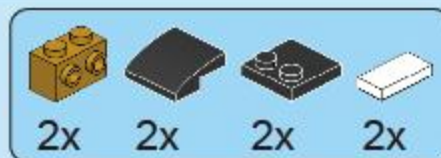
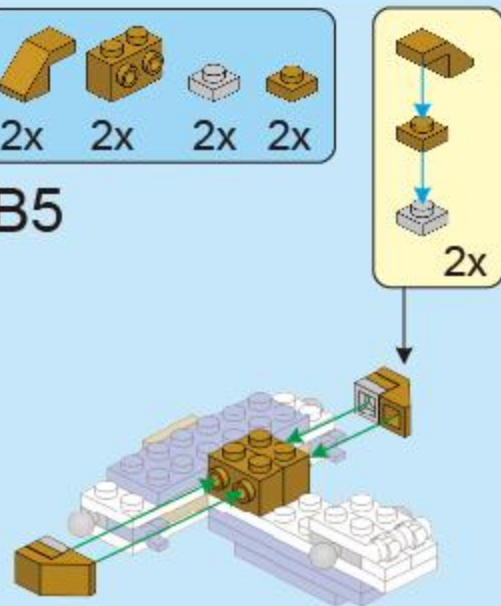

B6

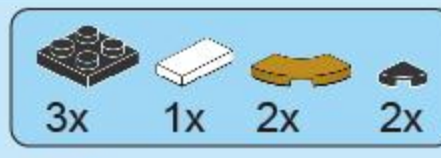

B7

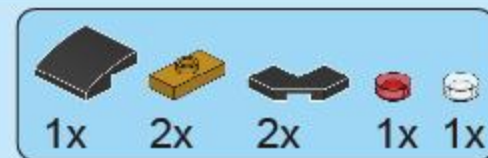
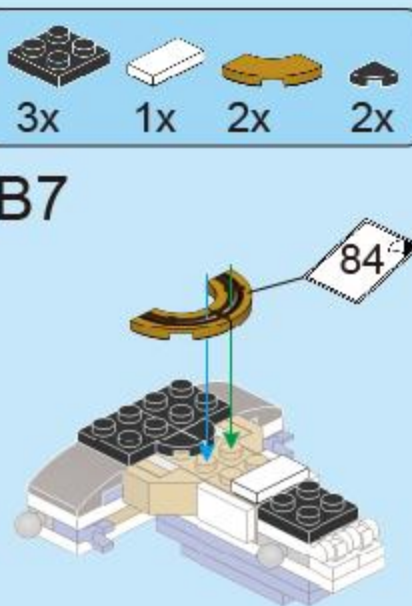

B8

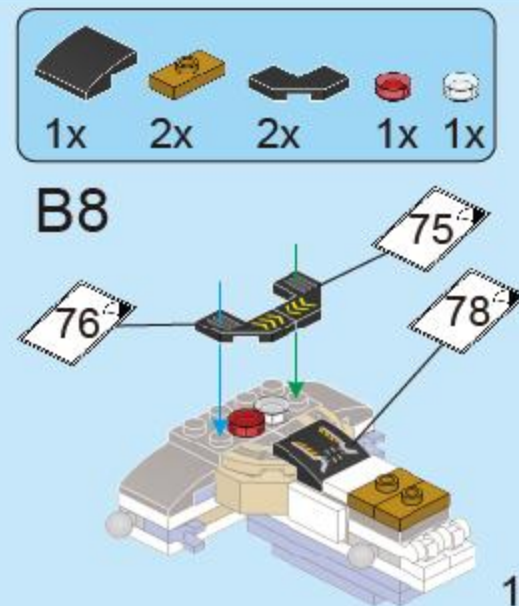

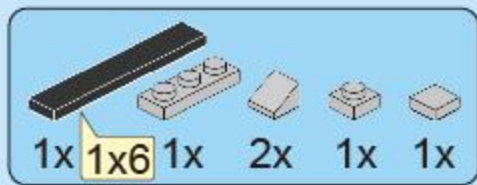

B9

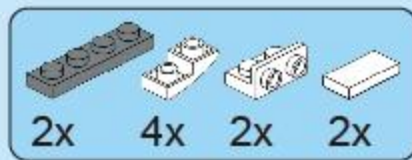
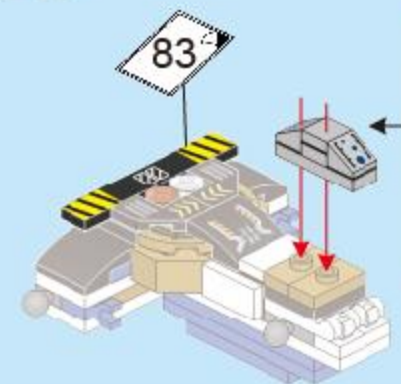

B10

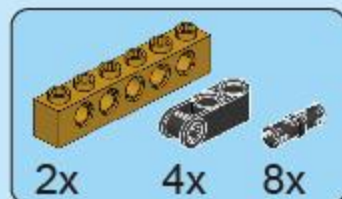
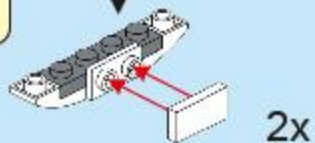
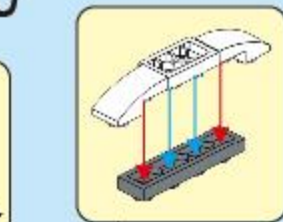
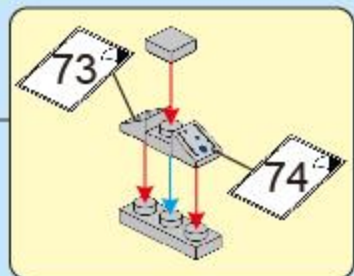

B11

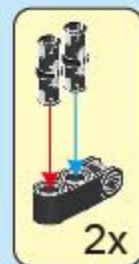
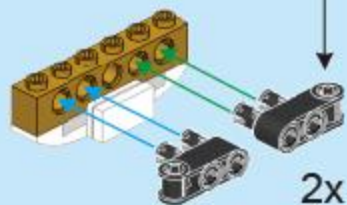

B12

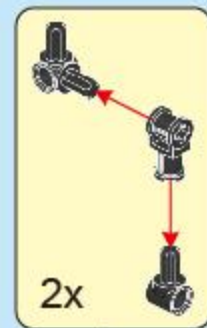
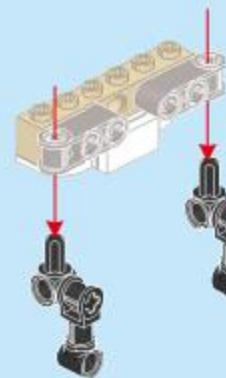

2x



A13

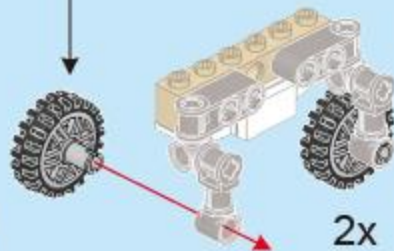

14

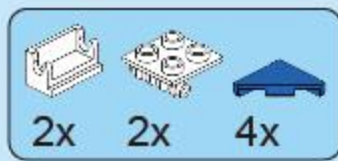

B14

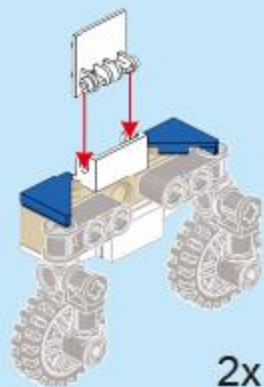

B15

B9



B14

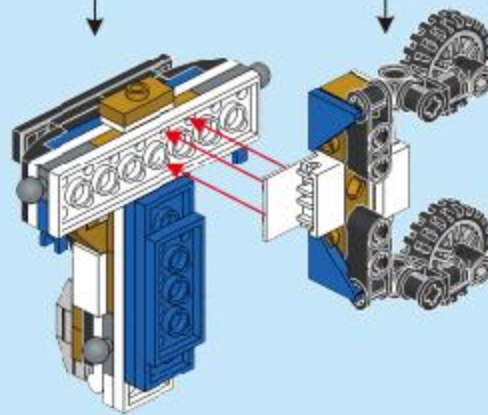

B16

B14

B15

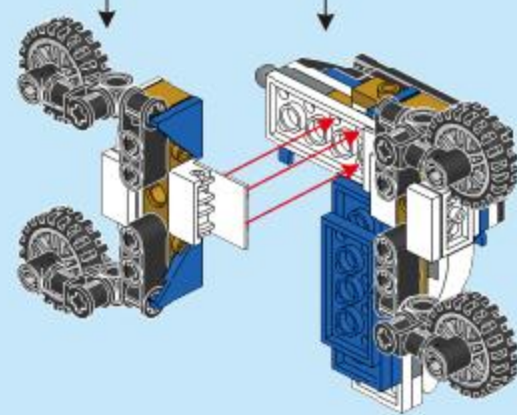

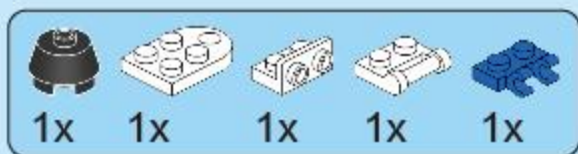

B17

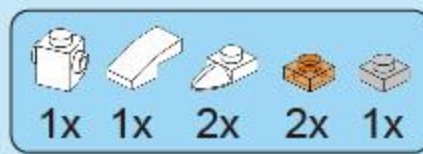
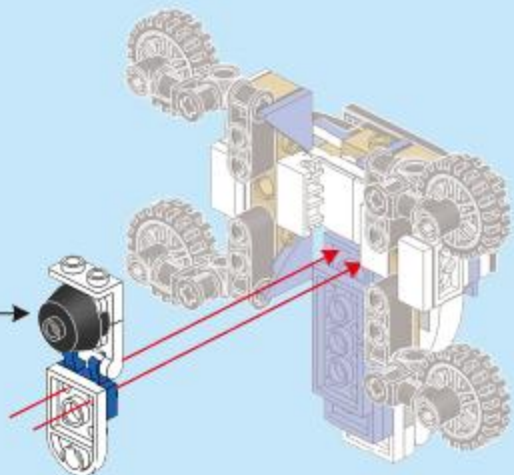
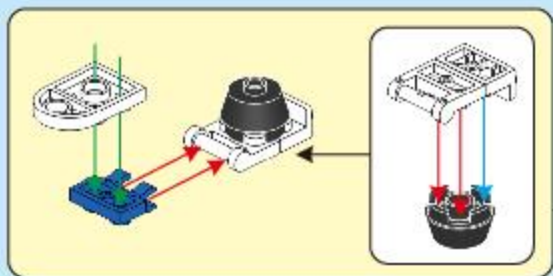

B18

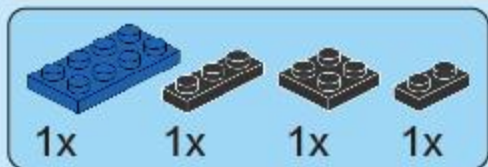
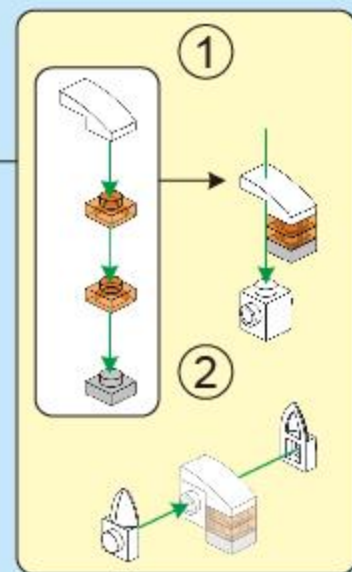
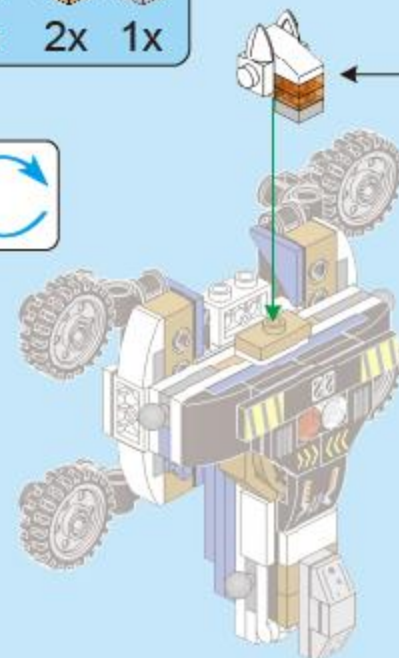

B19

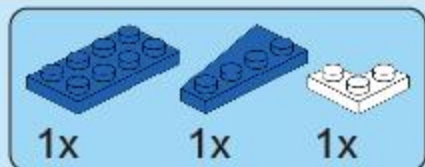
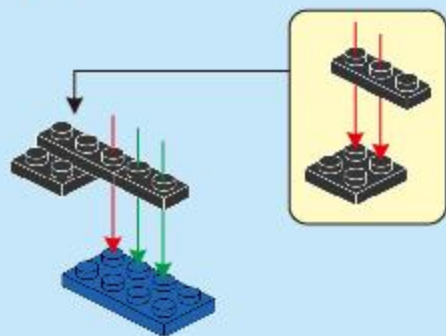

B20

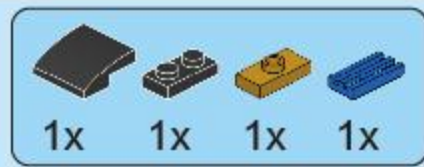
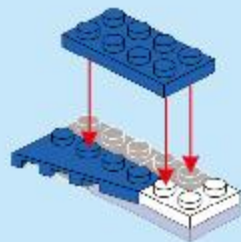

B21

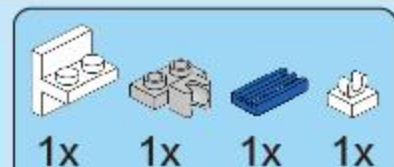
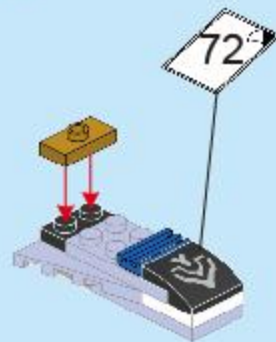

B22

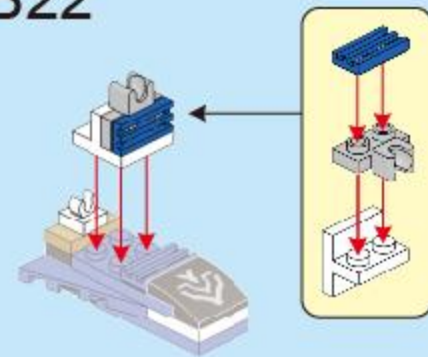

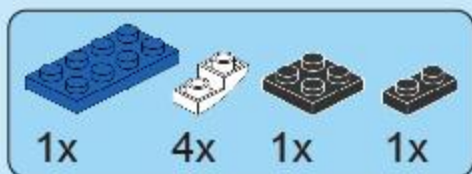

B23

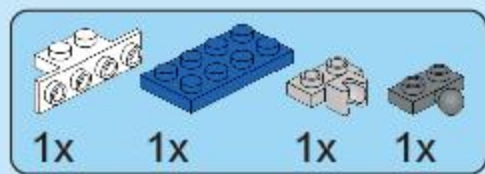
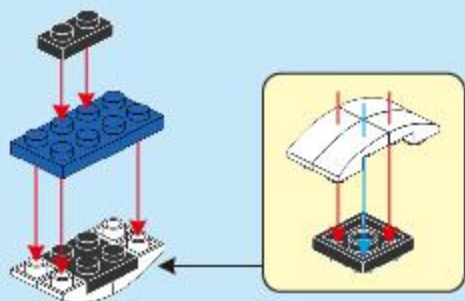

B24

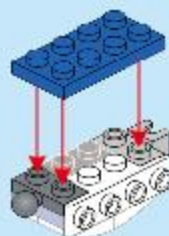

B25

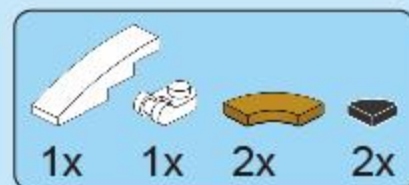
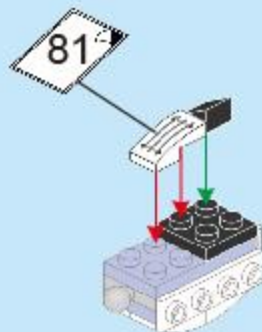

B26

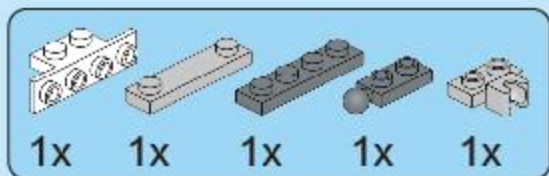
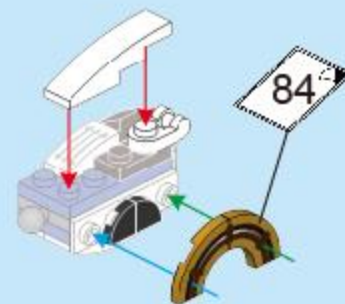

B27

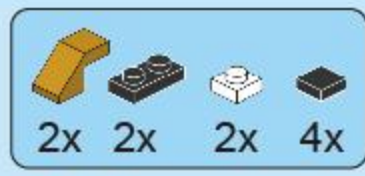
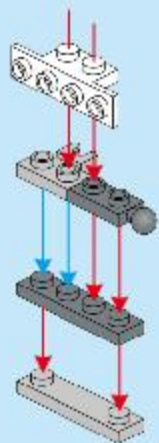

B28

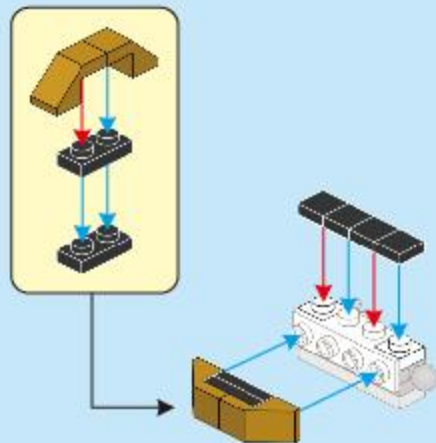

B29

B28



B26



B22

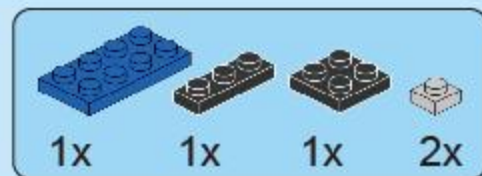

B30

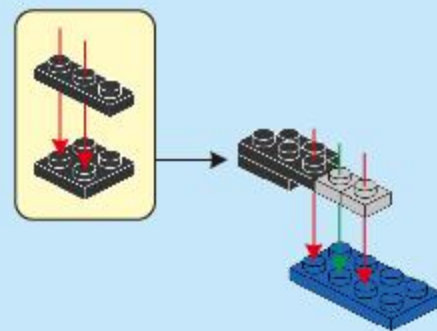

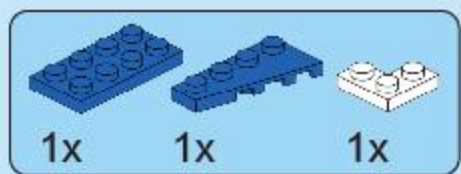

B31

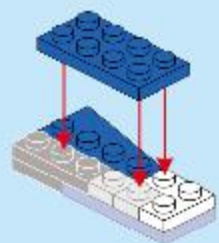

B32

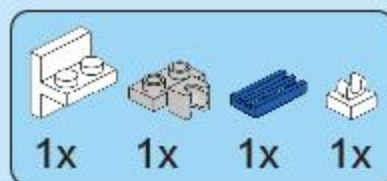
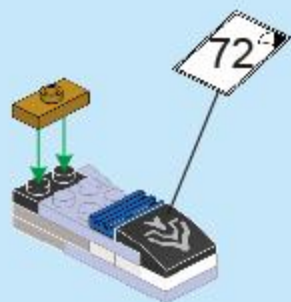

B33

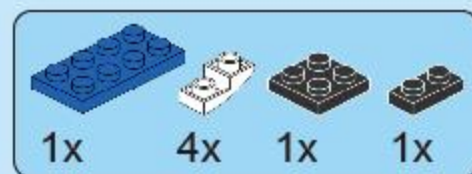
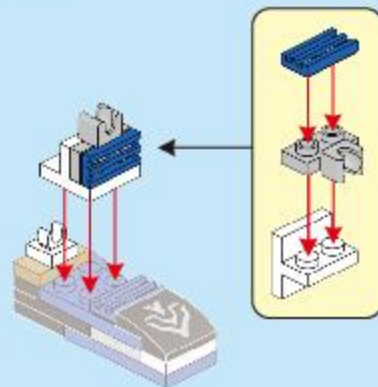

B34

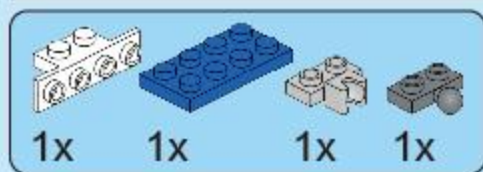
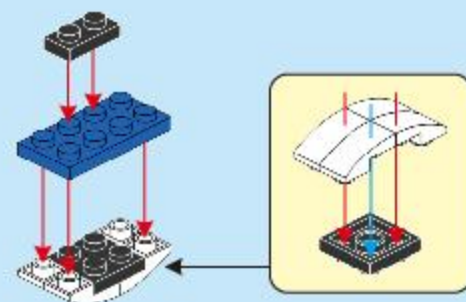

B35

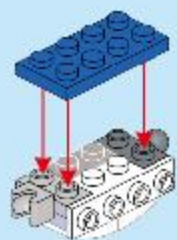

B36

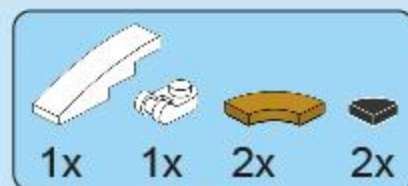
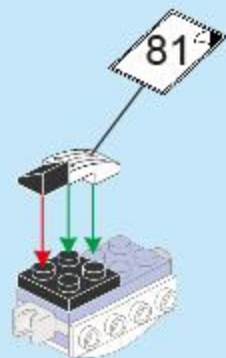

B37

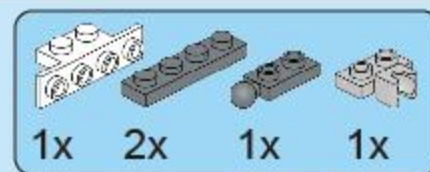
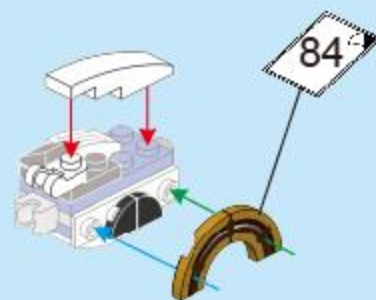

B38

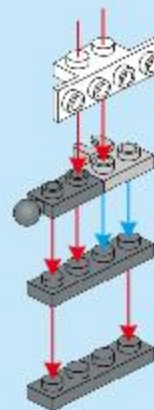

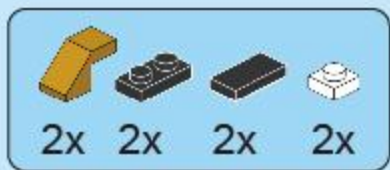

B39

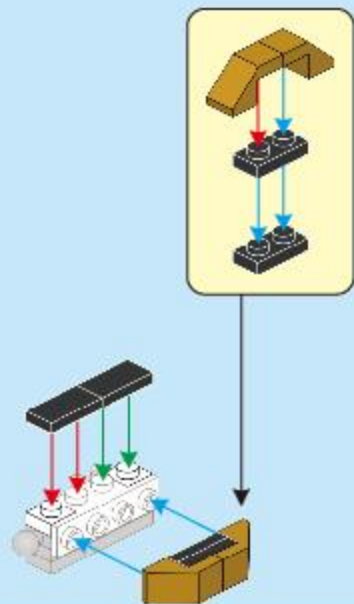

B40

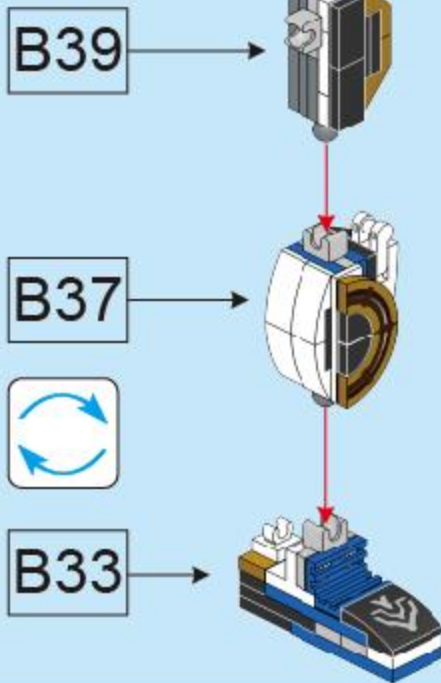

B41

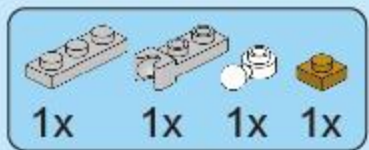
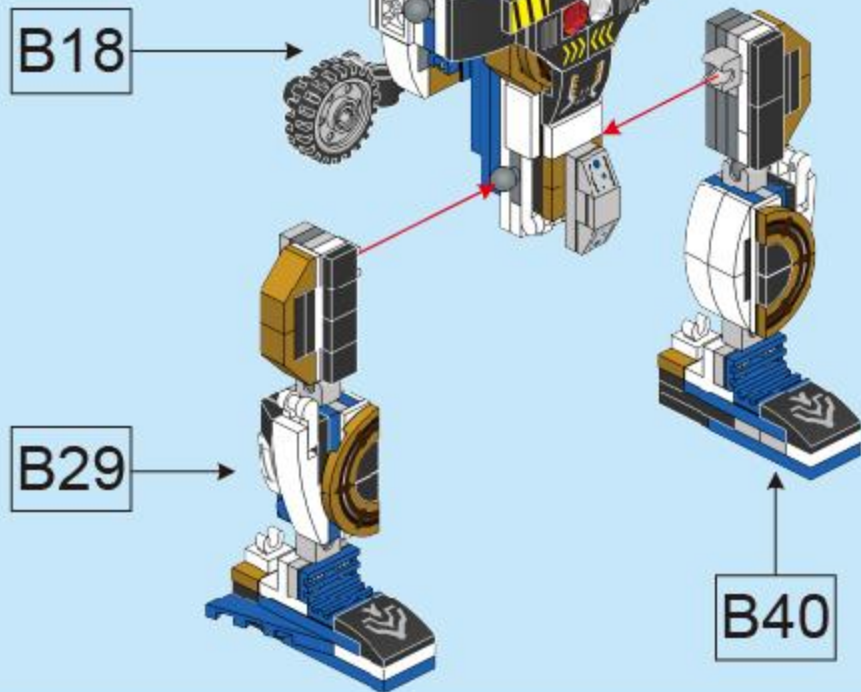

B42

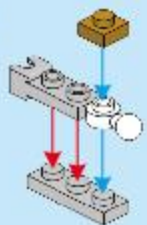

B43

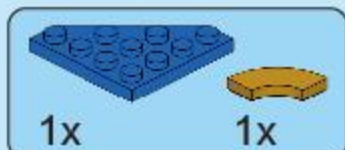
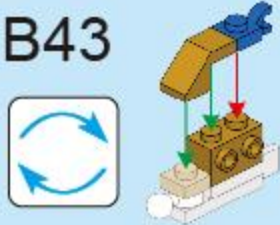

B44

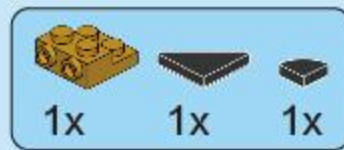
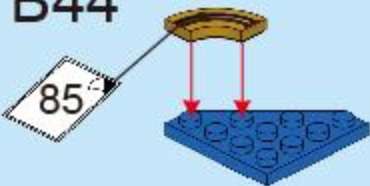

B45

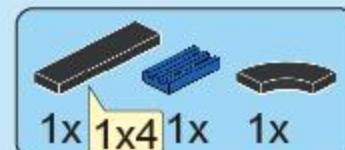
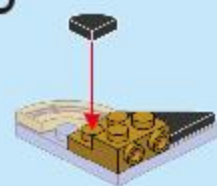

B46

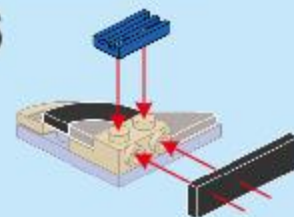

B47



B43

B46

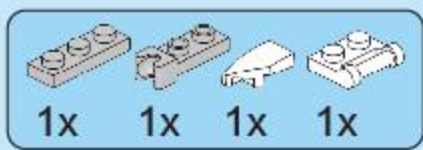
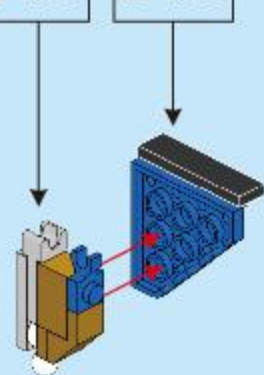

B48

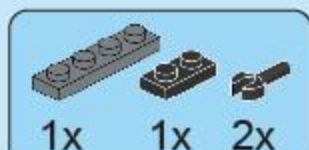
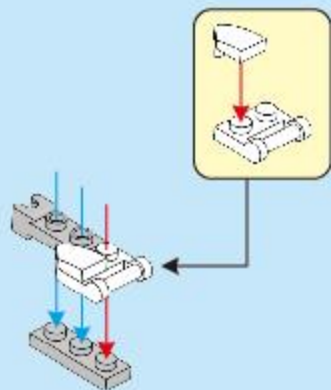

B49

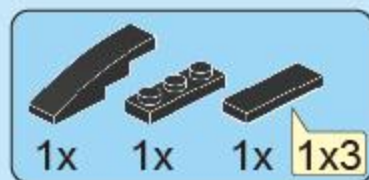
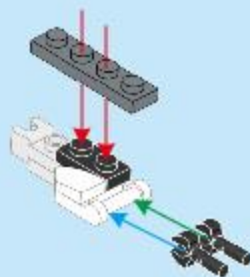

B50

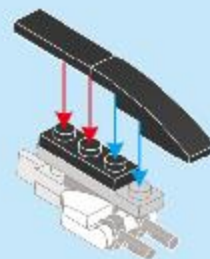

B51

B47



B50

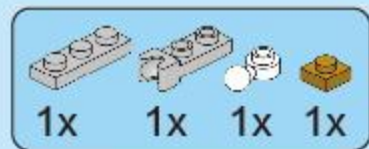

B52

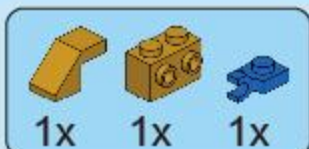
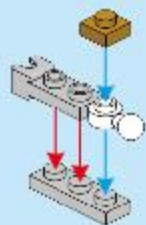

B53

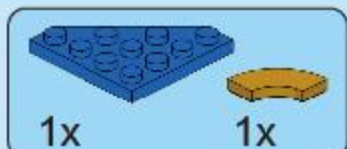
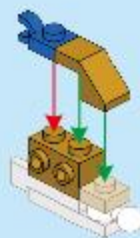

B54

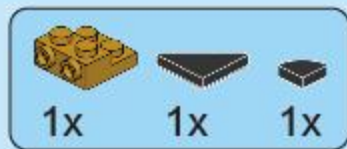
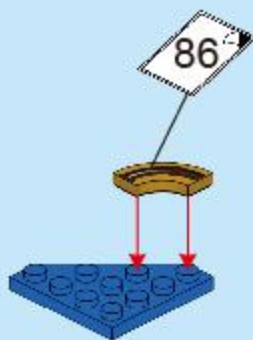

B55

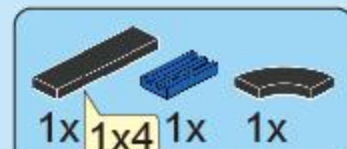
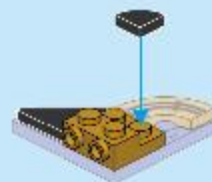

B56

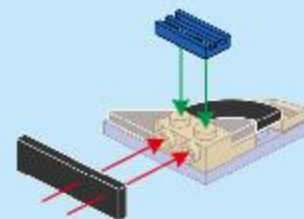

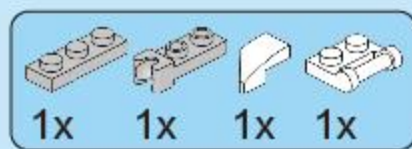
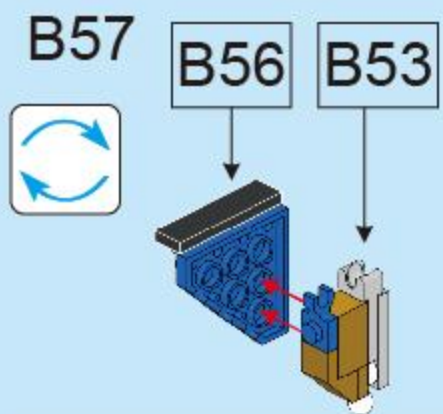

B58

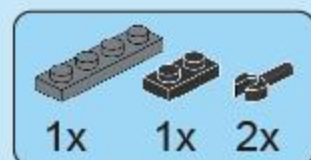
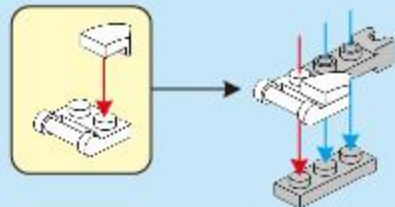

B59

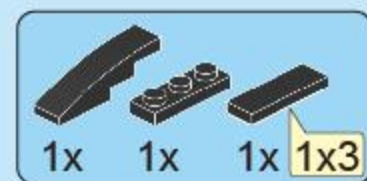
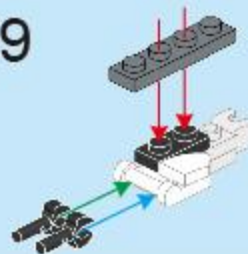

B60

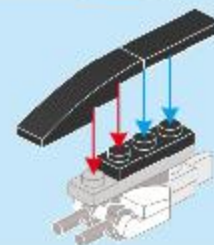

B61

B62

B



B57

B60

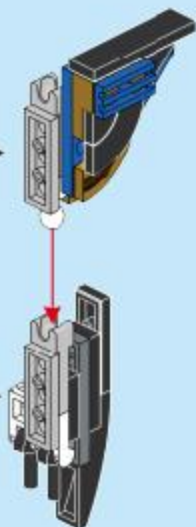

B41

B51



B61

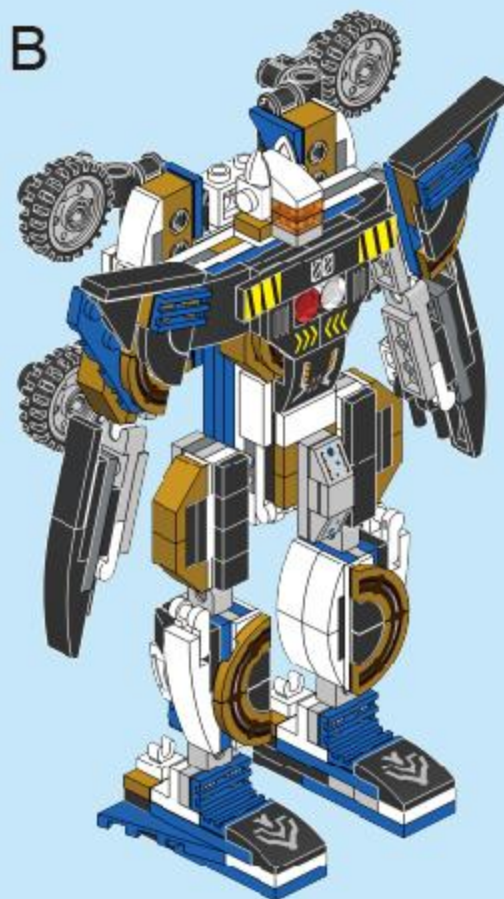

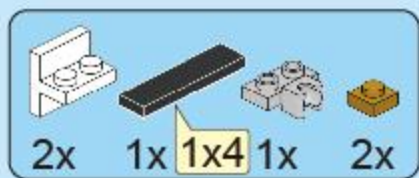

C1

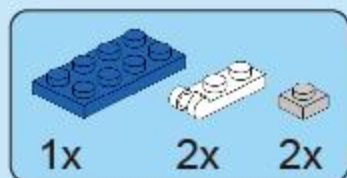
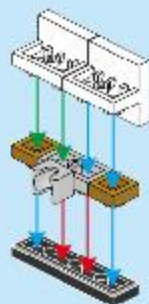

C2

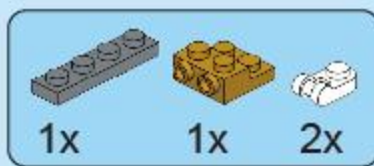
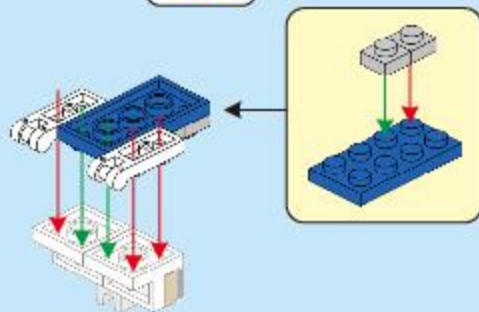

C3

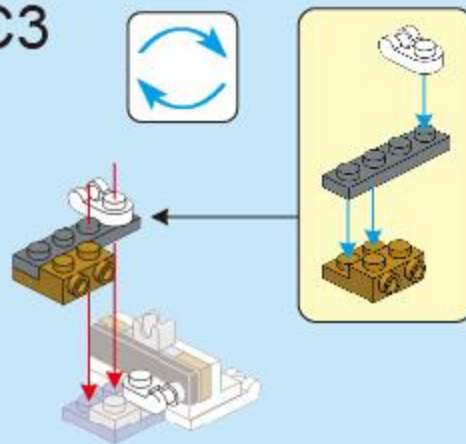

C4

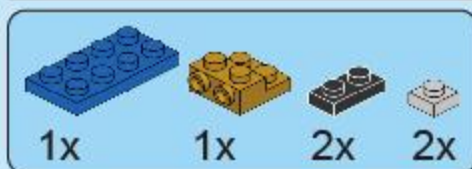
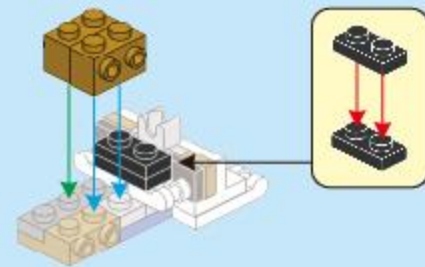

C5

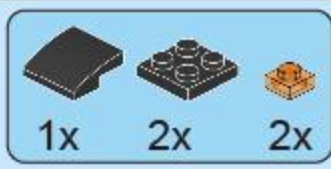
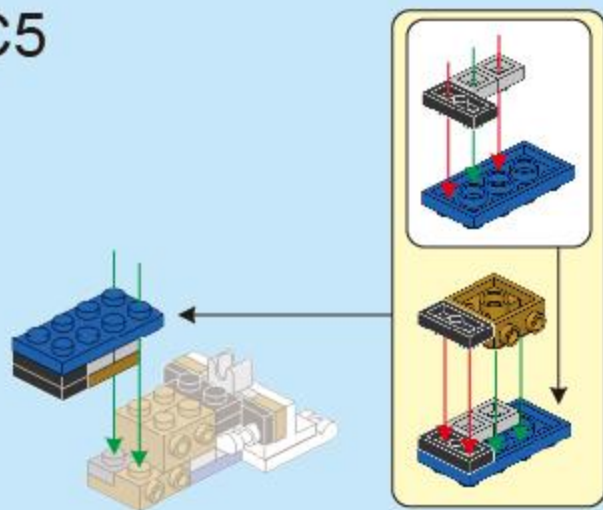

C6

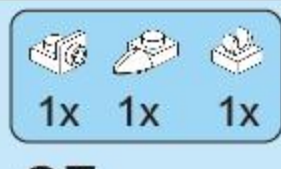
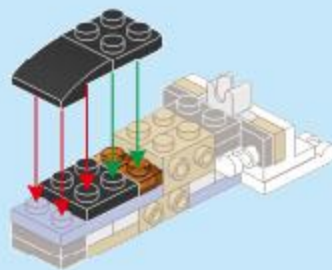

C7

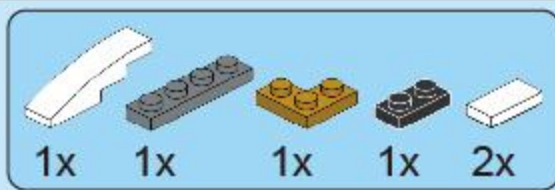
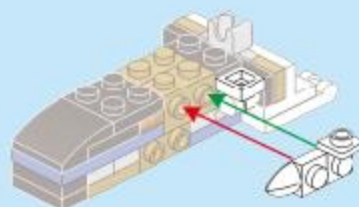

C8

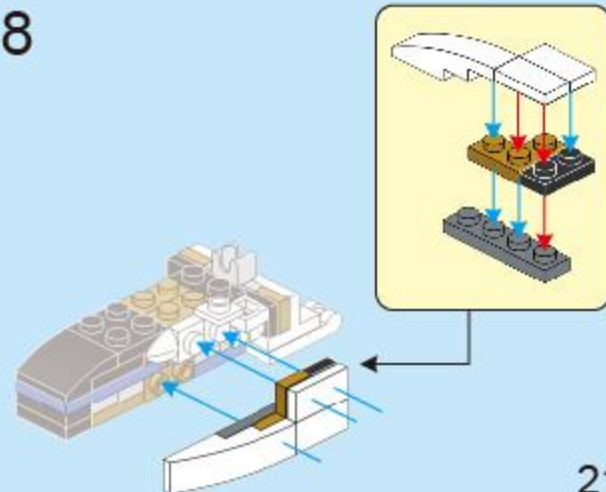



C9

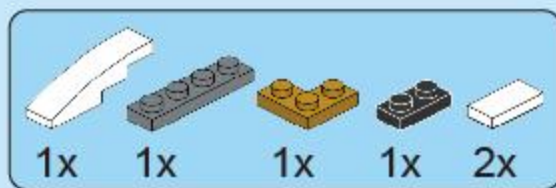
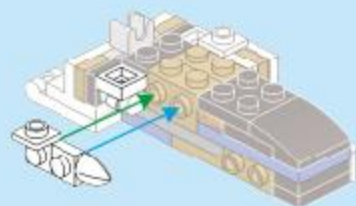

C10

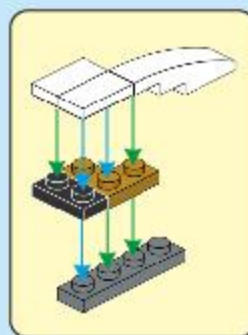
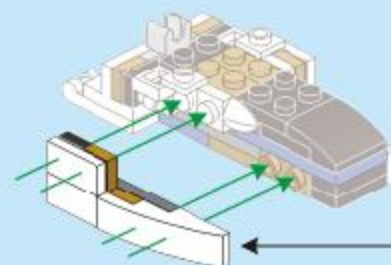

C11

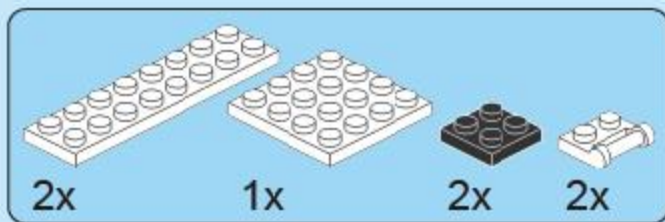
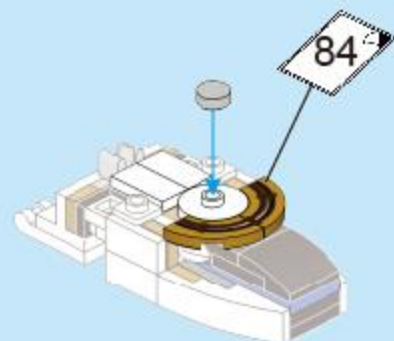

C12

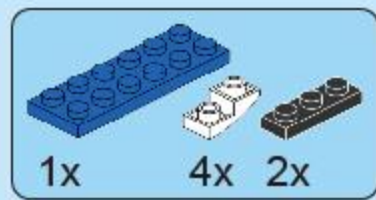
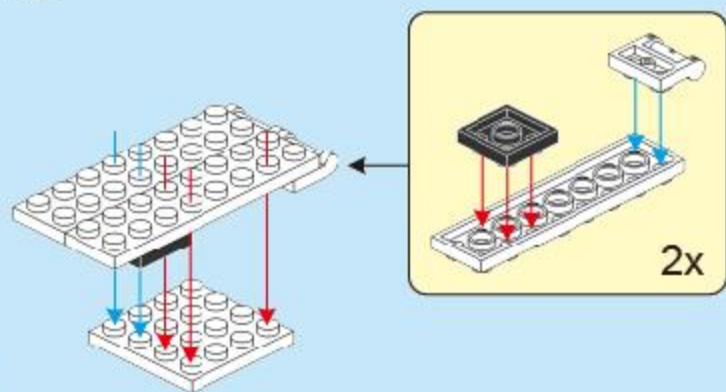

C13

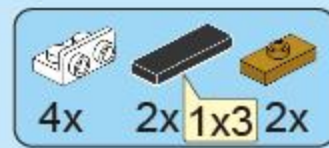
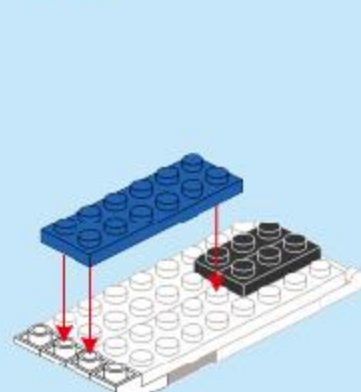

C14

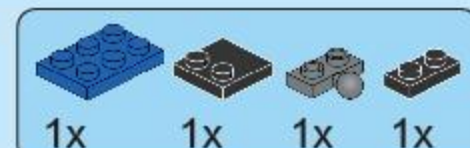
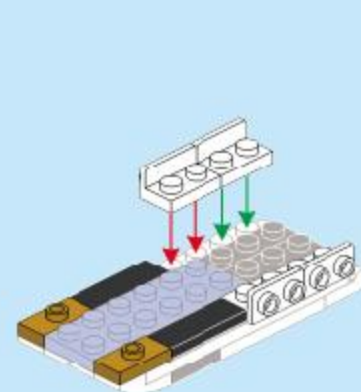

C15

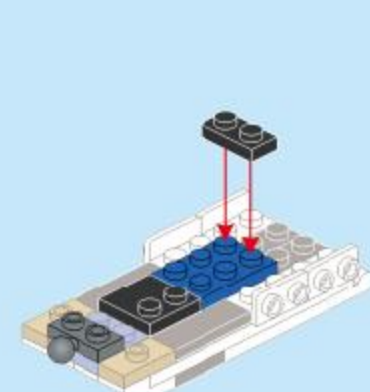

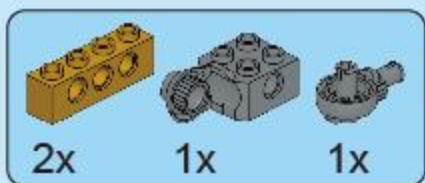

C16

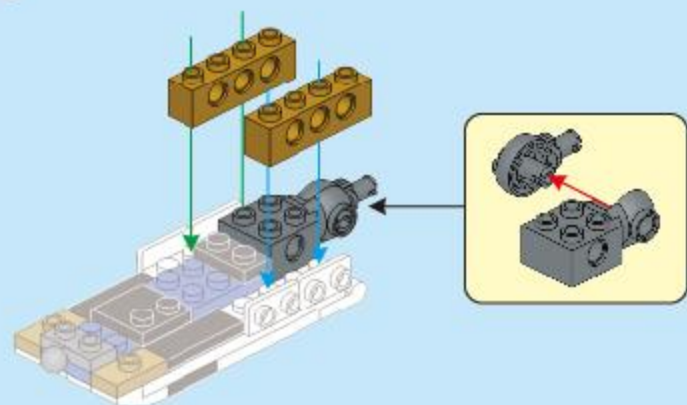

C17

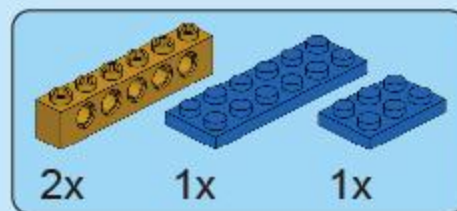
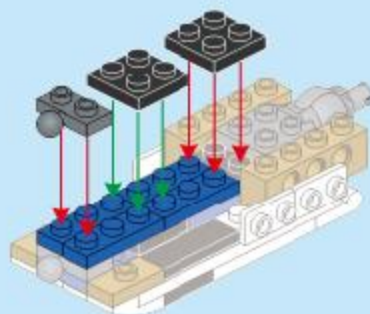

C18

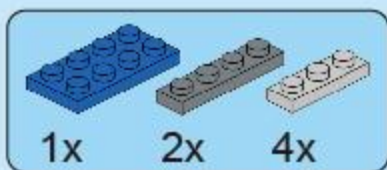
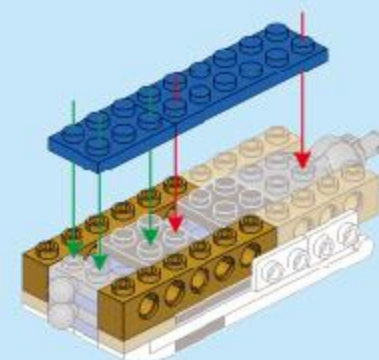

C19

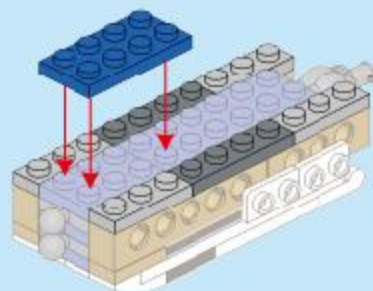

C20

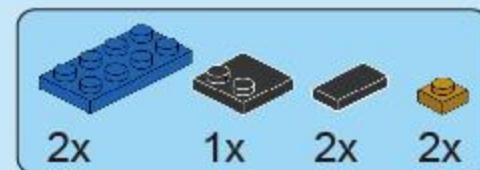
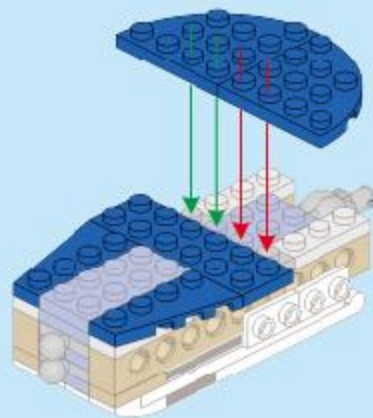

C21

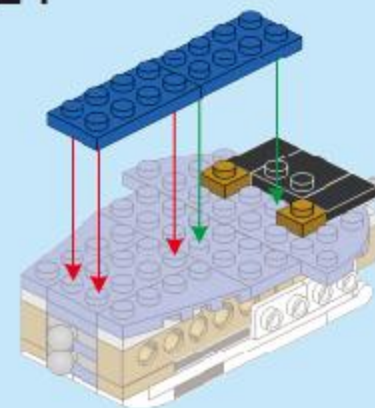

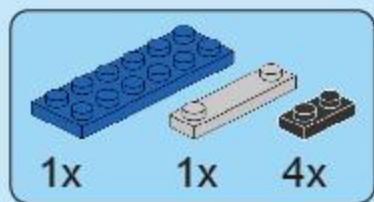

C22

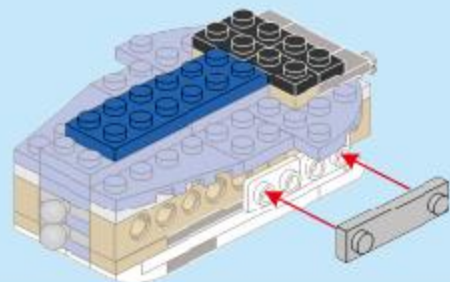

C23

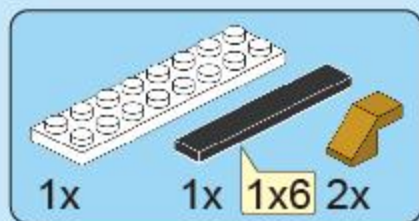
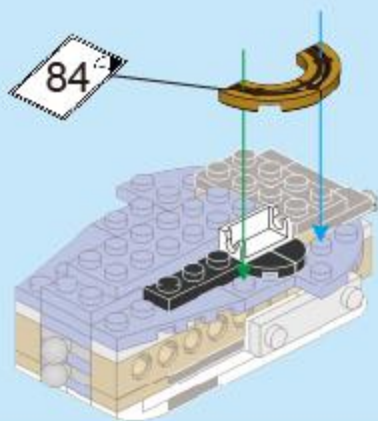

C24

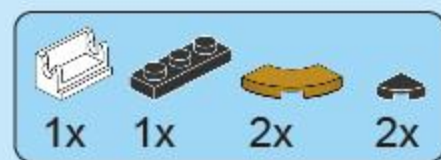
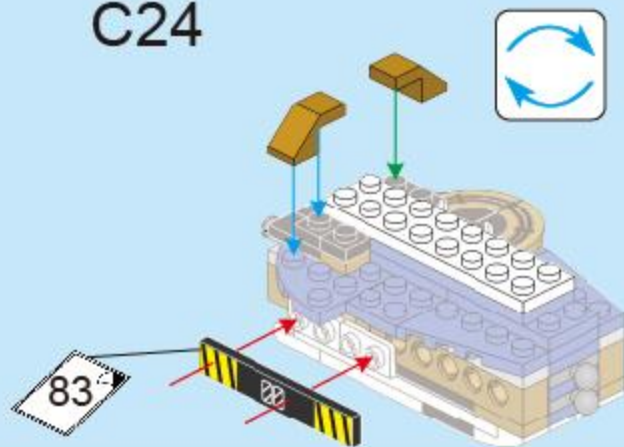

C25

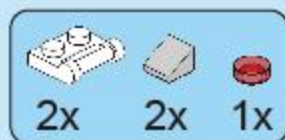
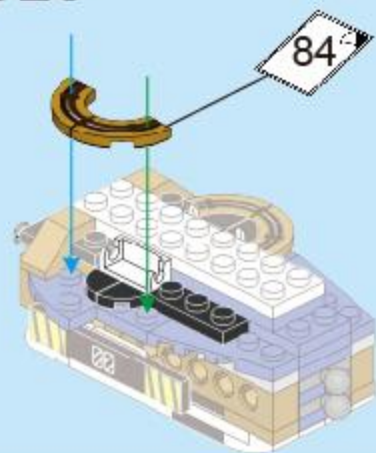

C26

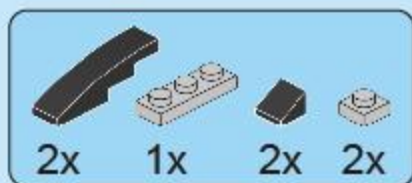
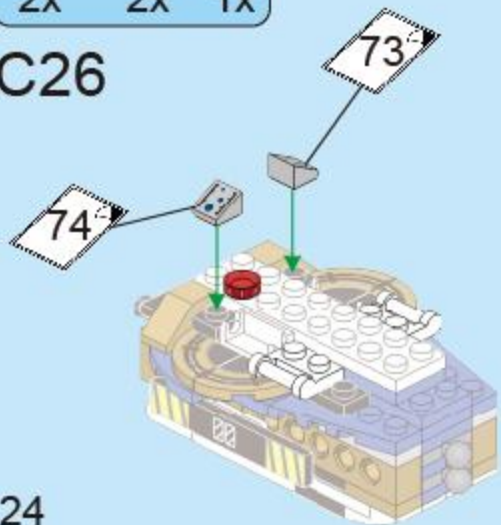

C27

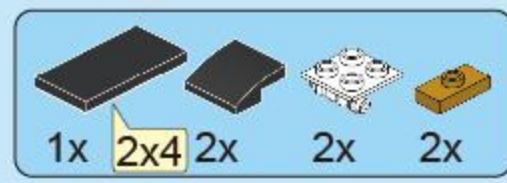
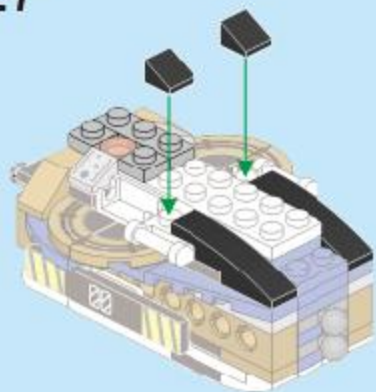

C28

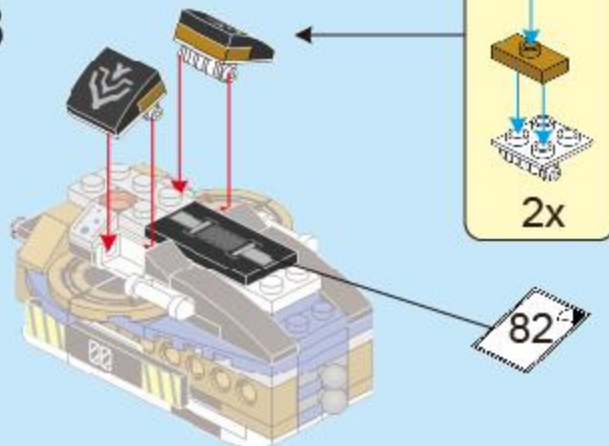



C29

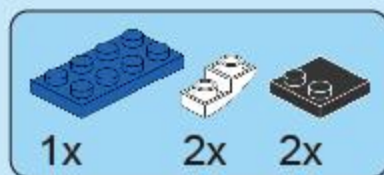
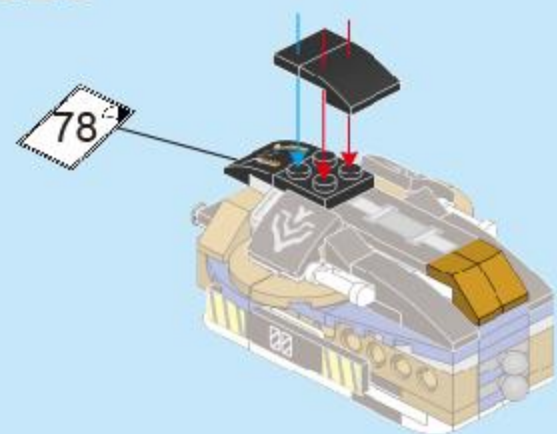

C30

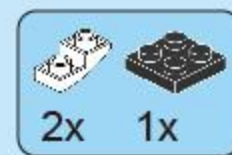
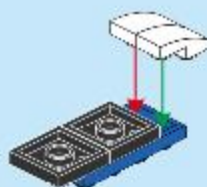
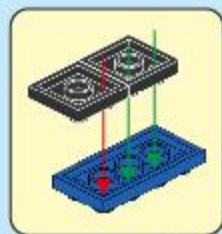

C31

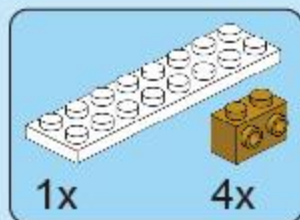
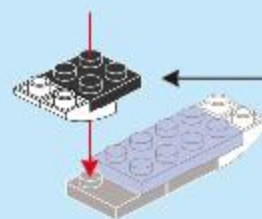
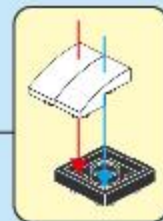

C32

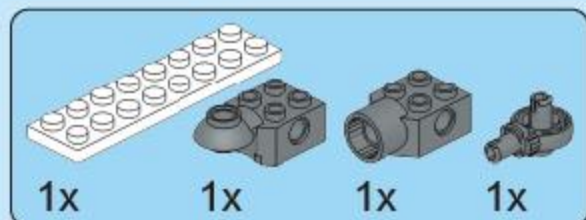
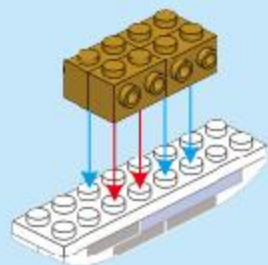

C33

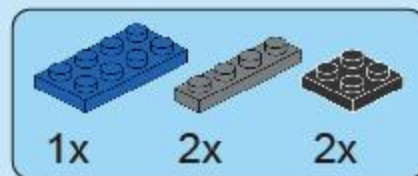
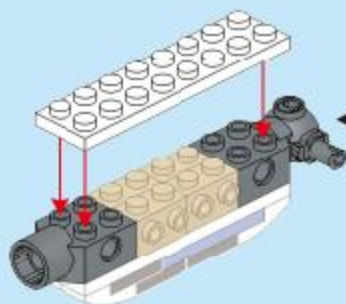
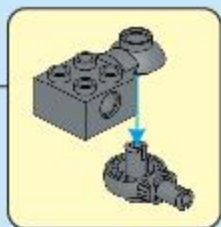

C34

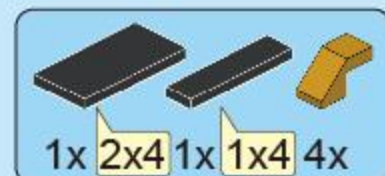
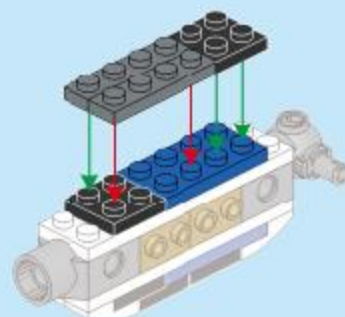

C35

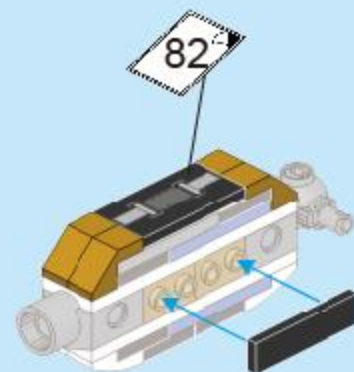



C36

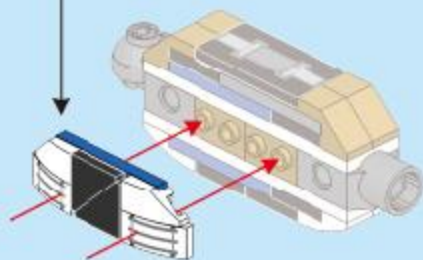
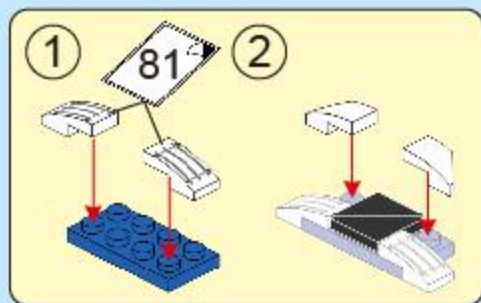

26

C37

C36



C29



C11

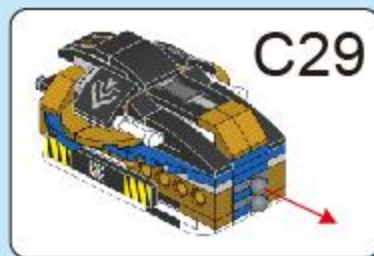
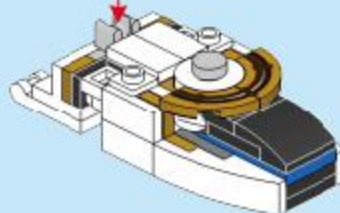

C

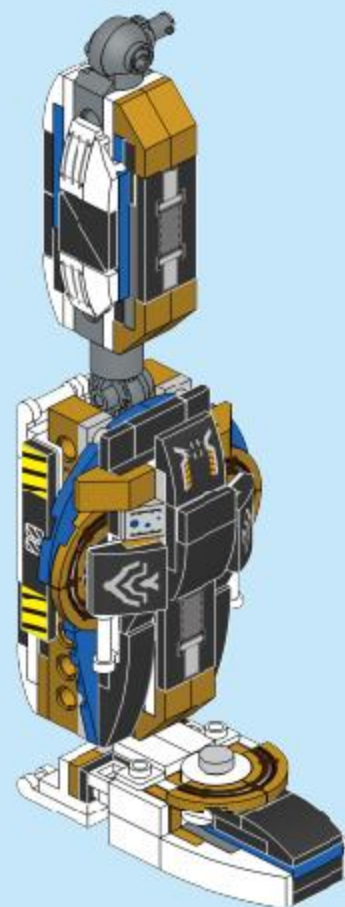

FC1033C
(C56)



FC1033C
(C61)



FC1035C



FC1031C

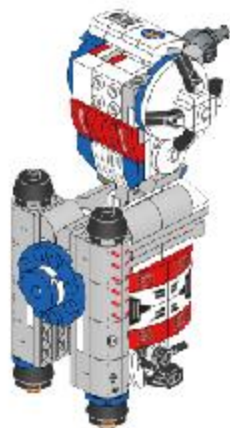

FC1032C



FC1033C
(C48)



FC1034C

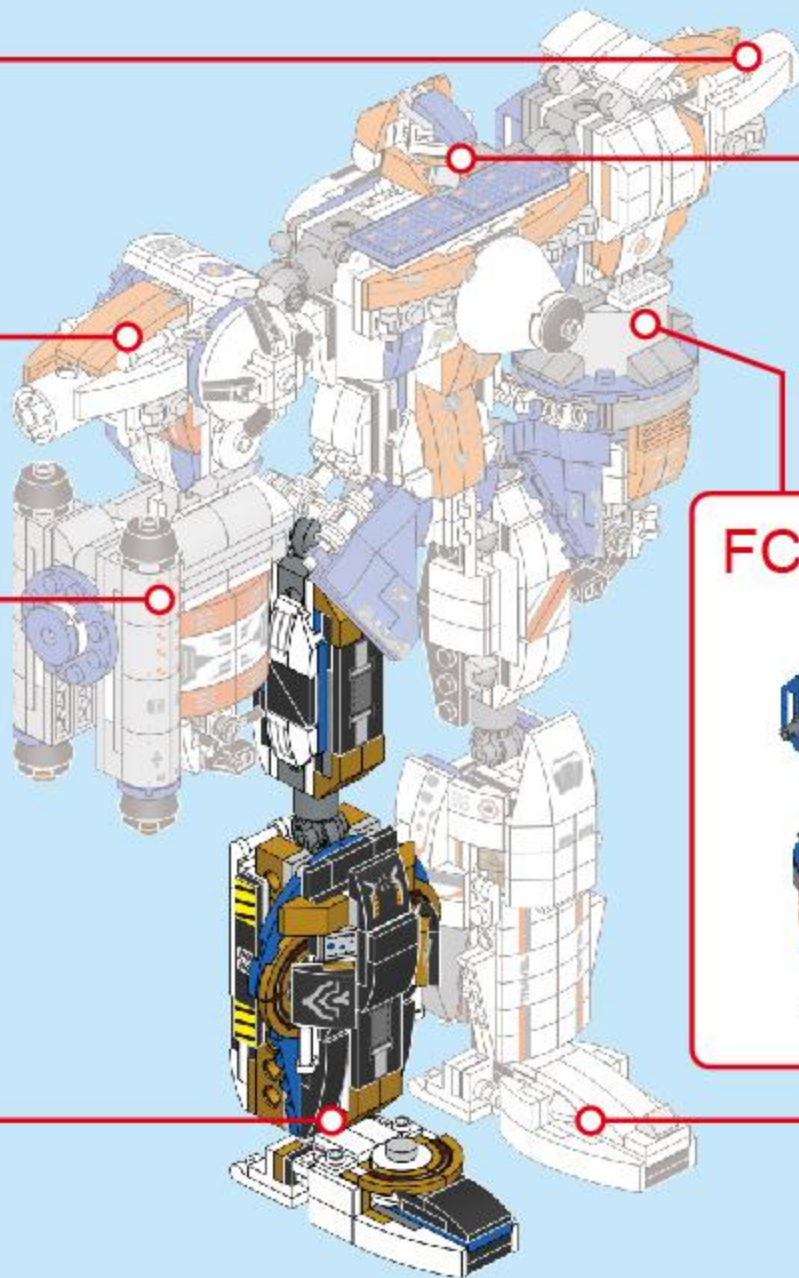
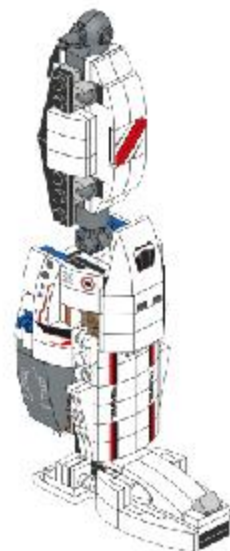



2 IN 1
TRANSFORMS



COLLECT 5 MODELS
TO COMBINE GOD OF WAR ODIN

UNDER