

FC3322

# CITY



FORM 2



3IN1

FORM 3





+



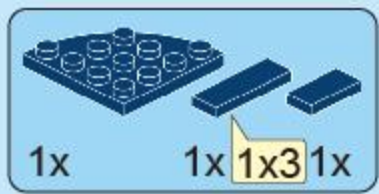

1

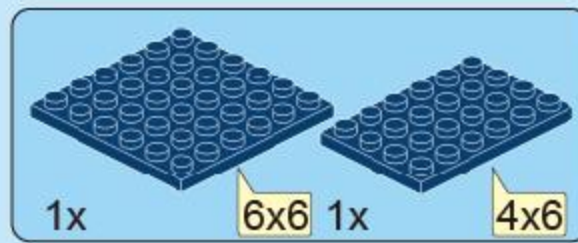

2

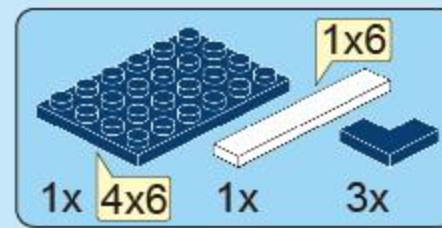
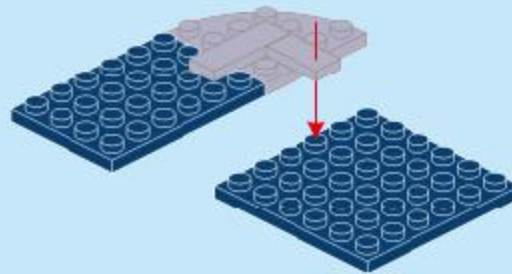

3

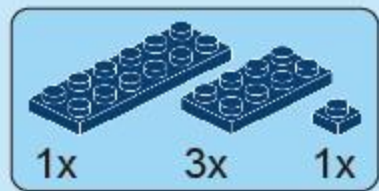
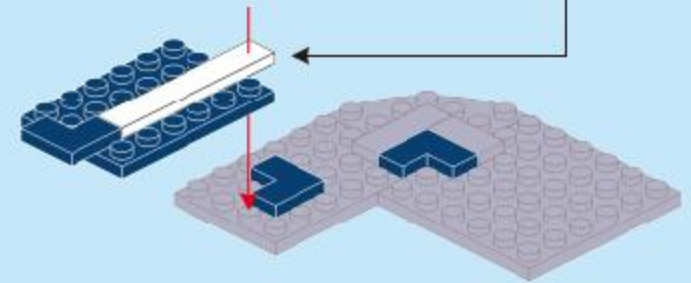
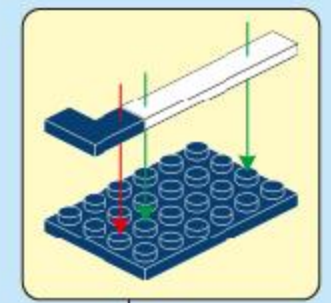

4

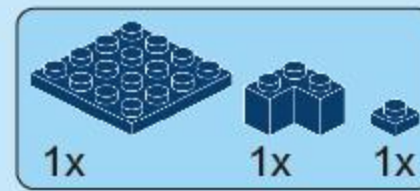
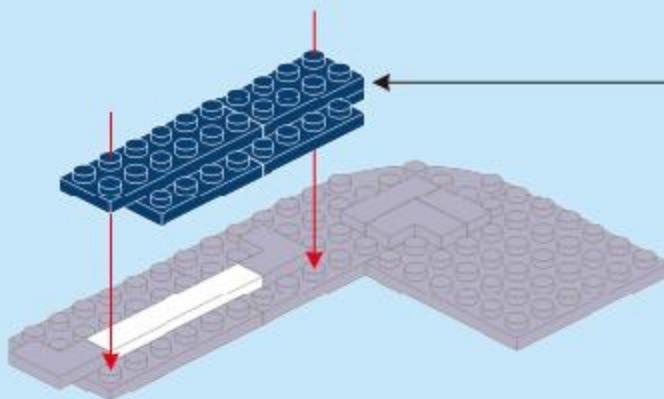
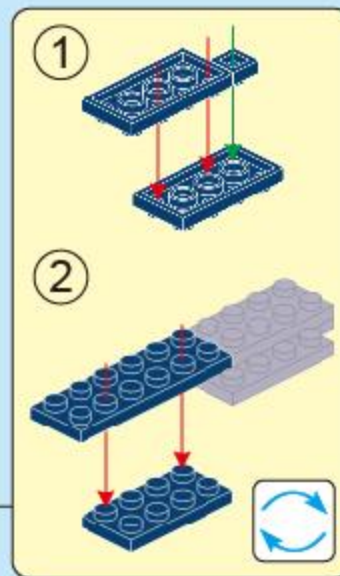

5

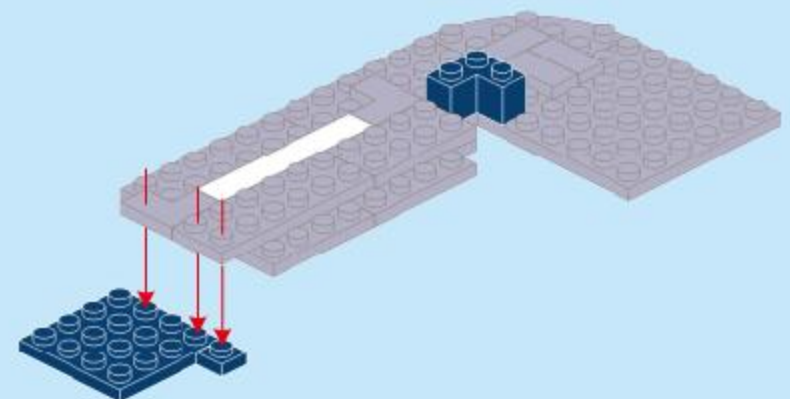



6

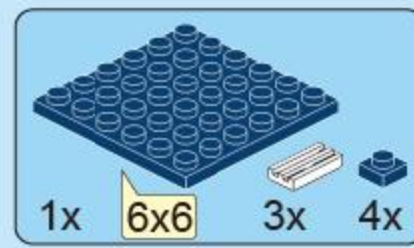
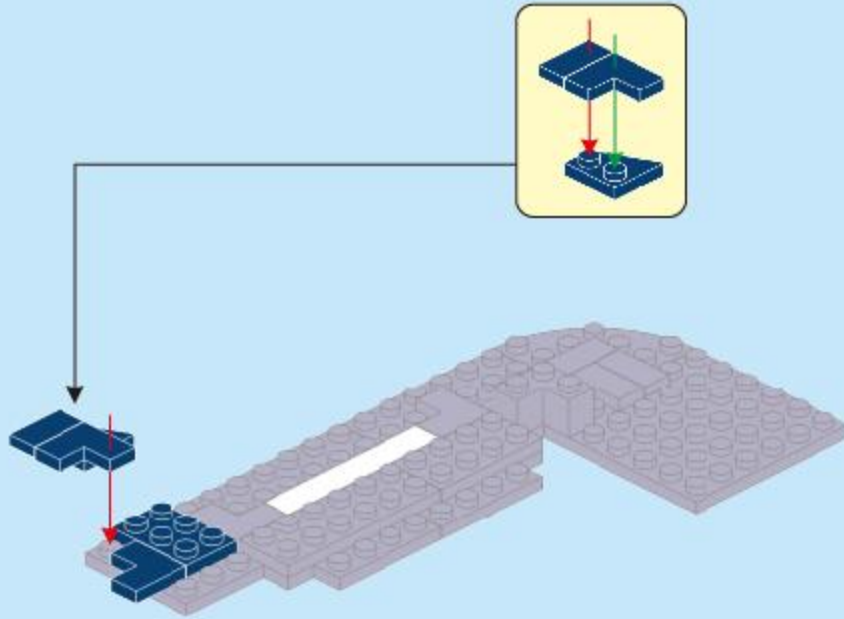

7

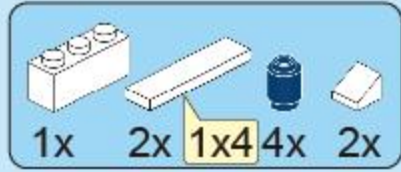
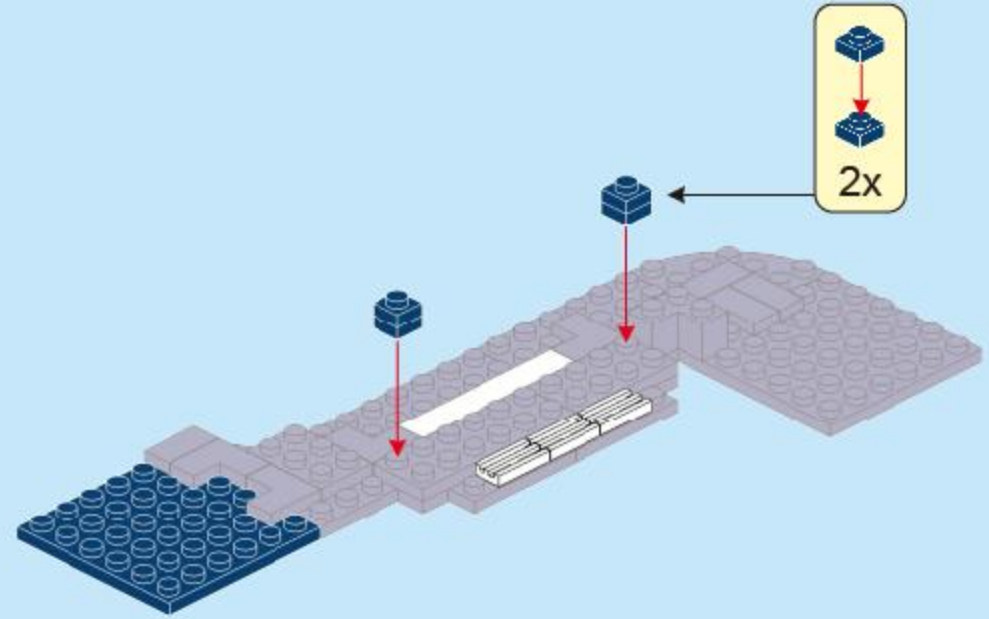

8

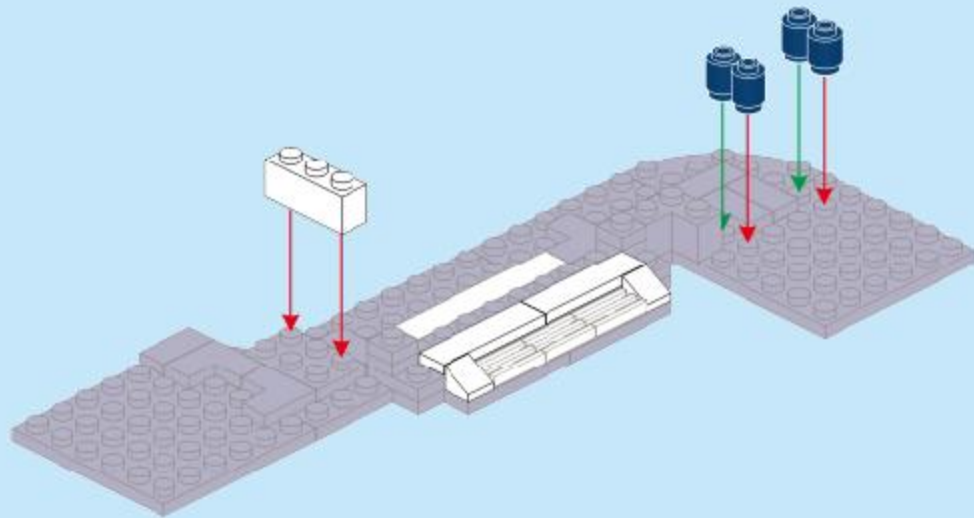

4



9

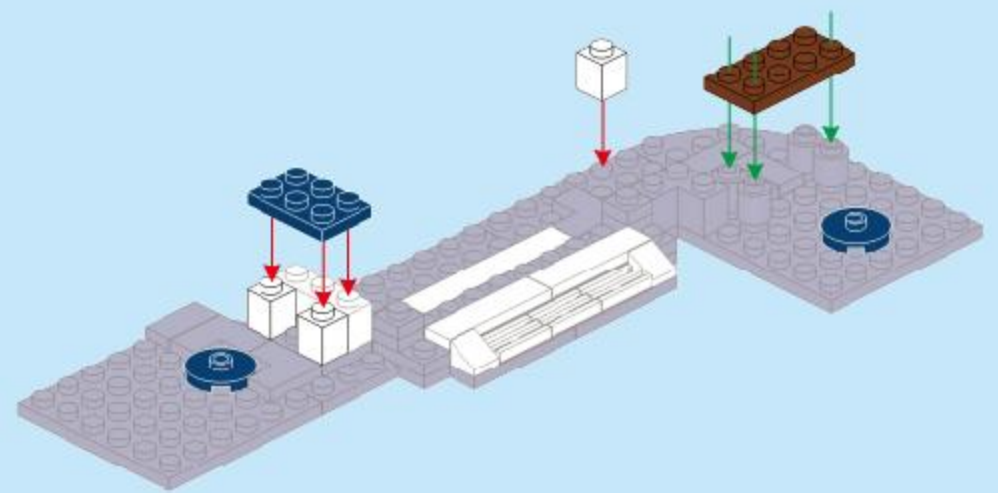

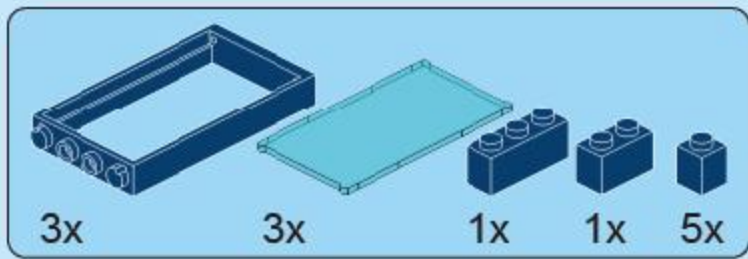

10

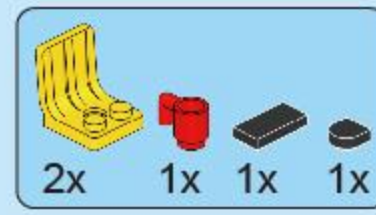
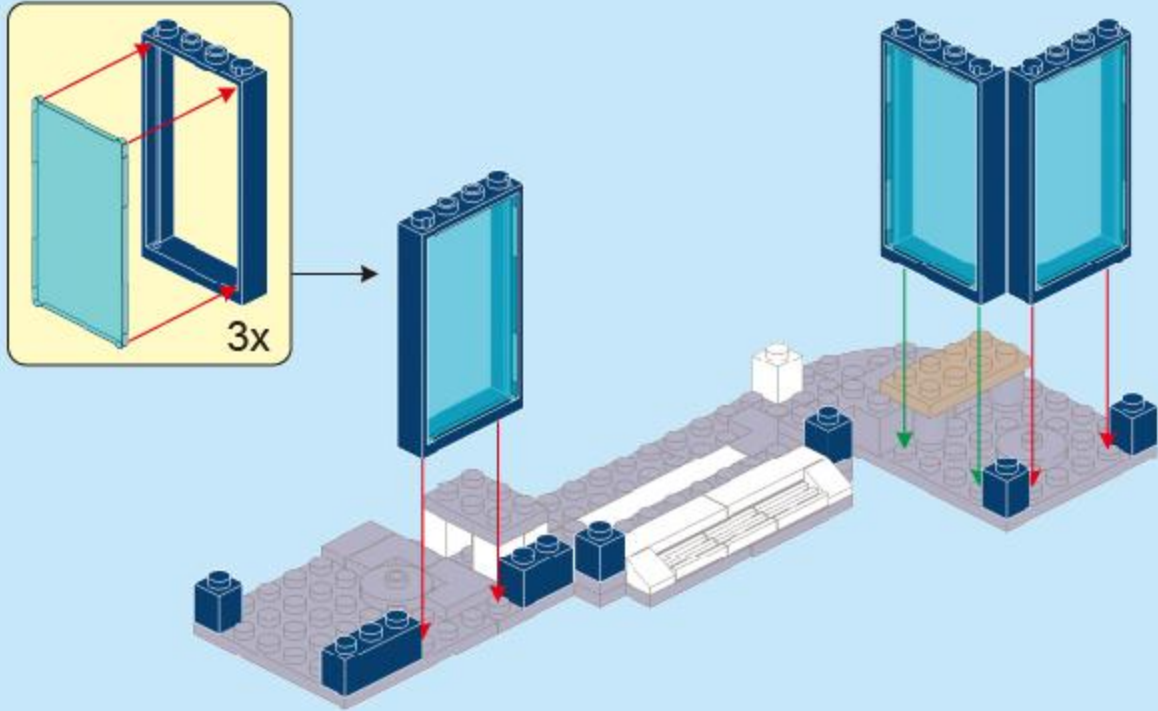

11

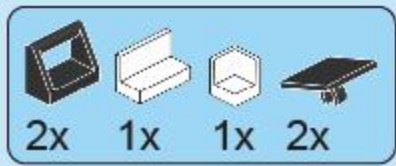
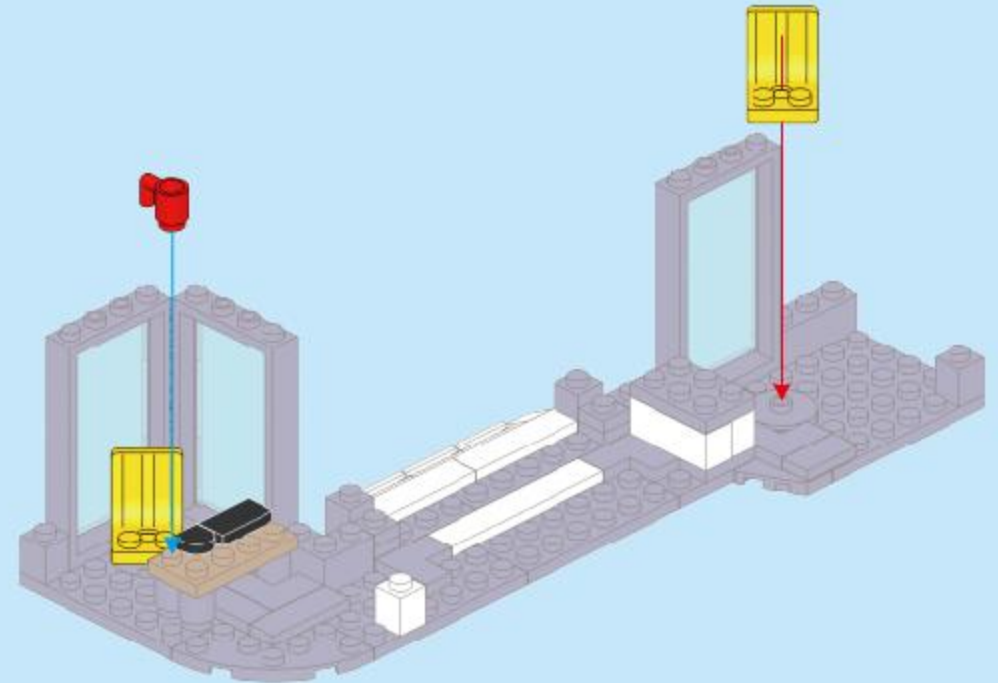

12

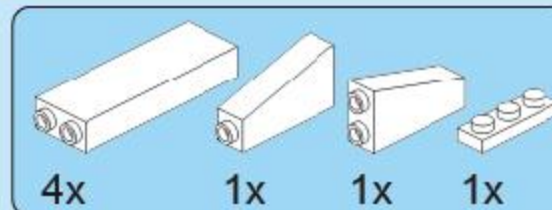
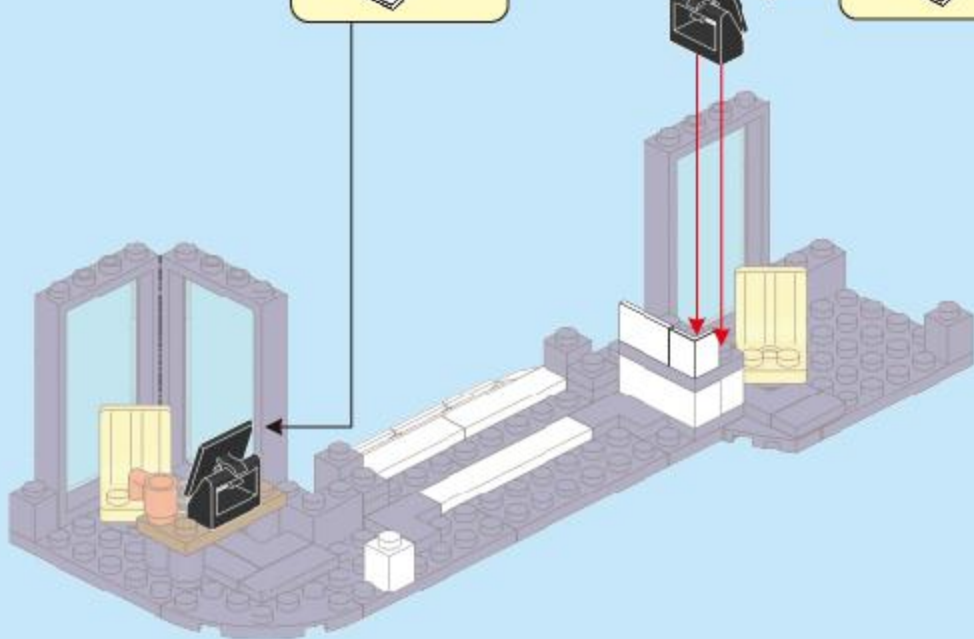
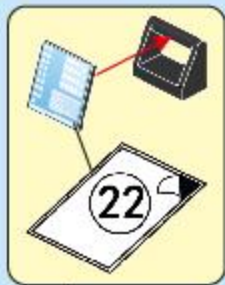

13

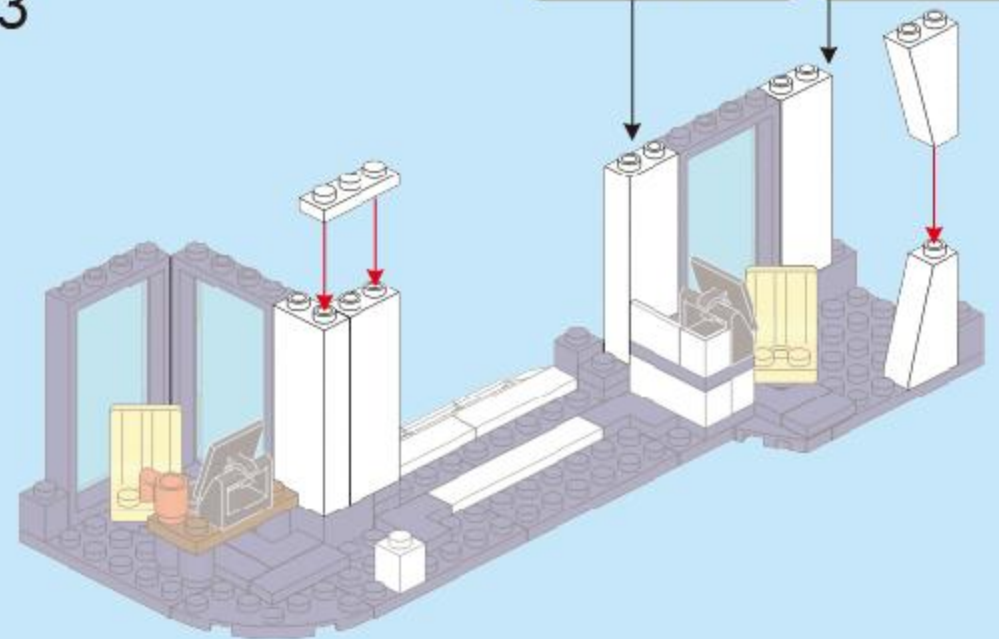
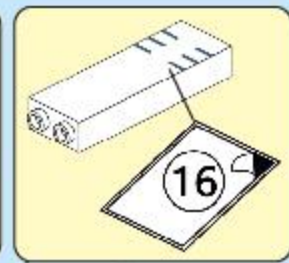
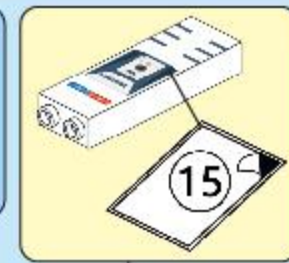

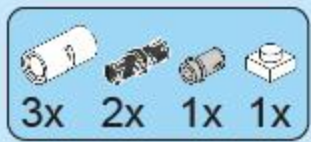

14

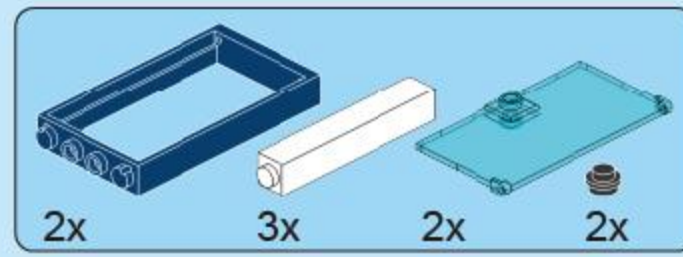
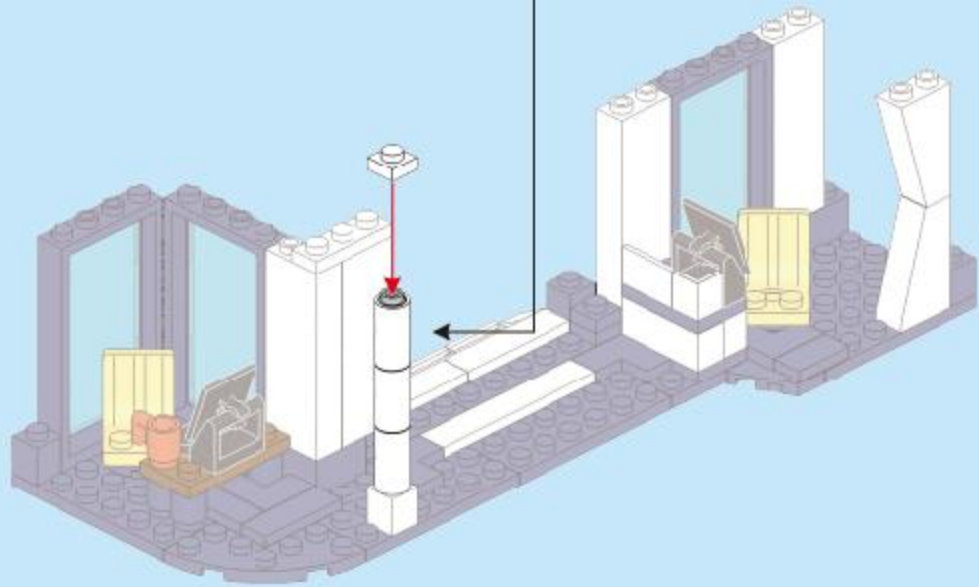
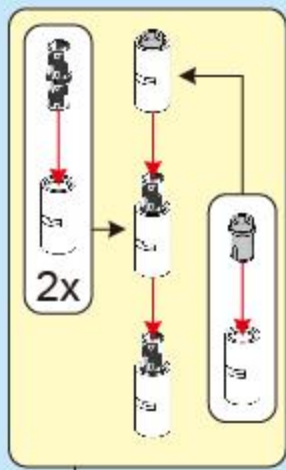

15

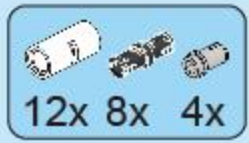
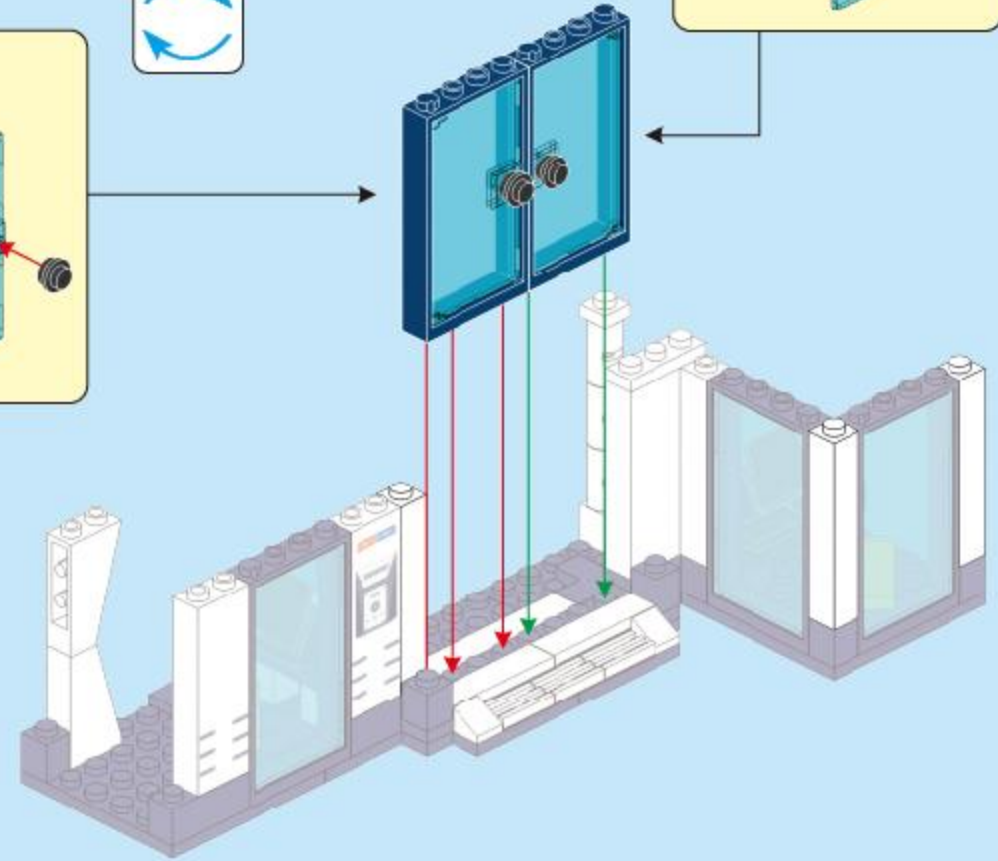
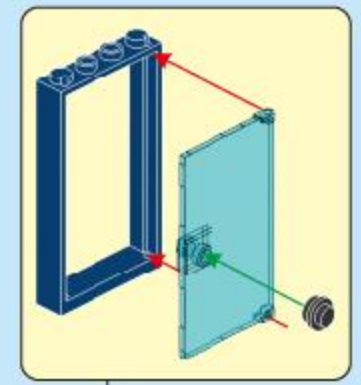
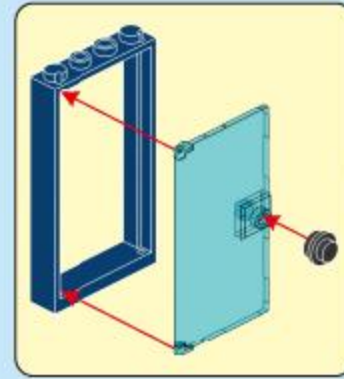

16

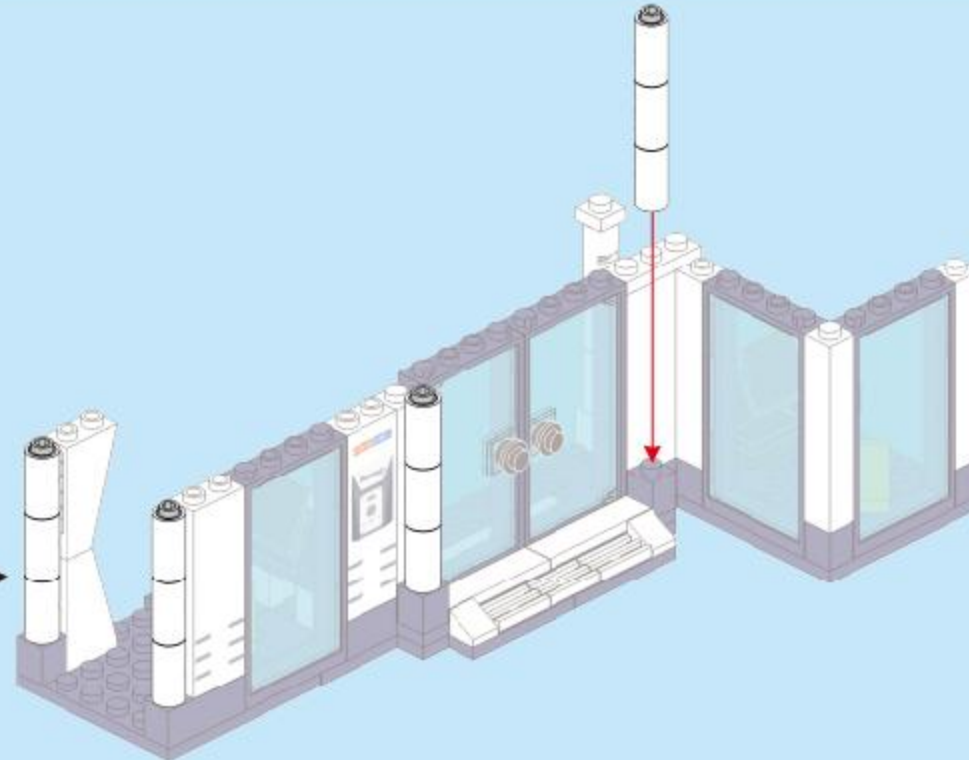
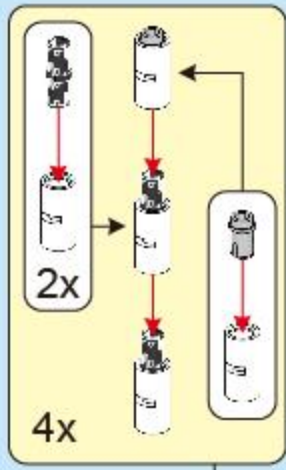

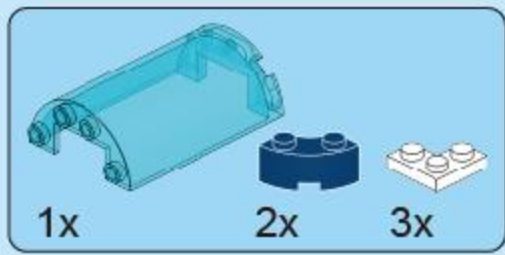

17

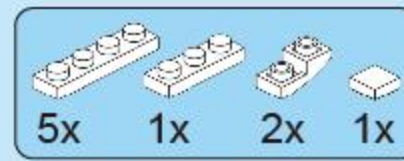
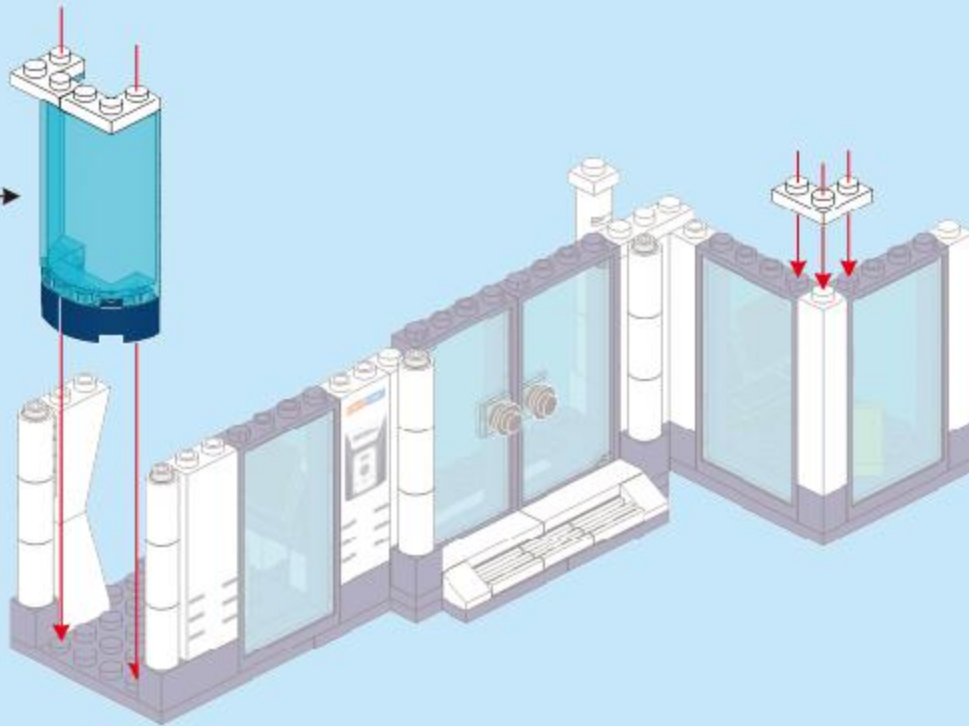
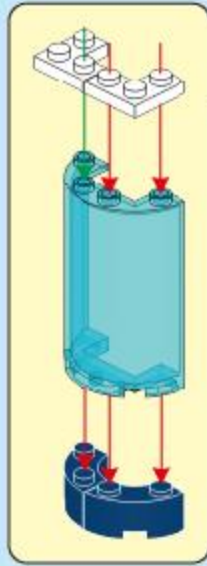

18

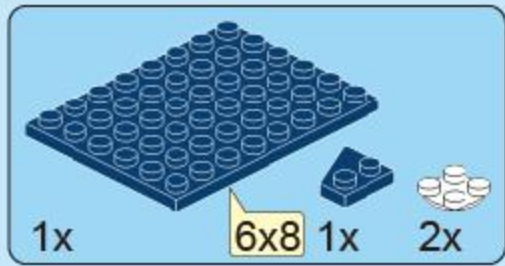
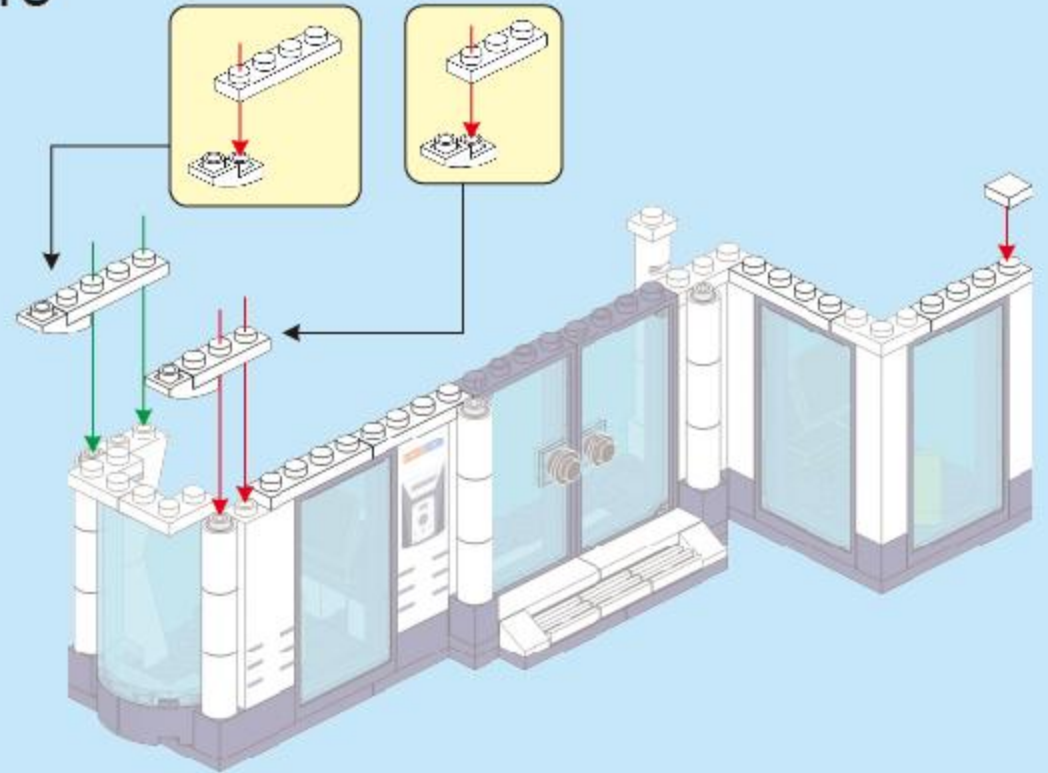

19

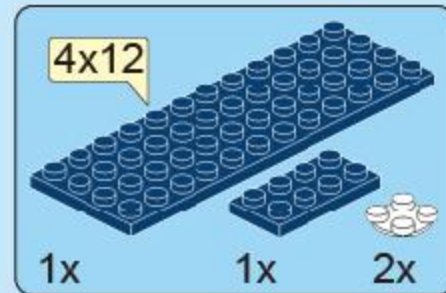
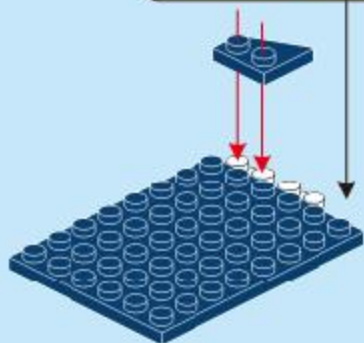
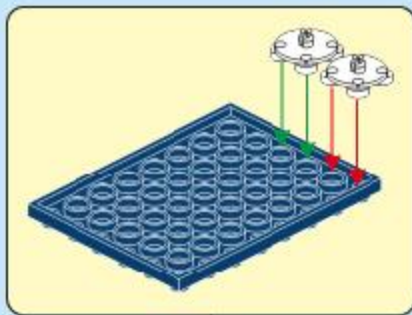

20

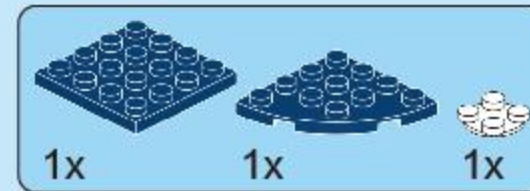
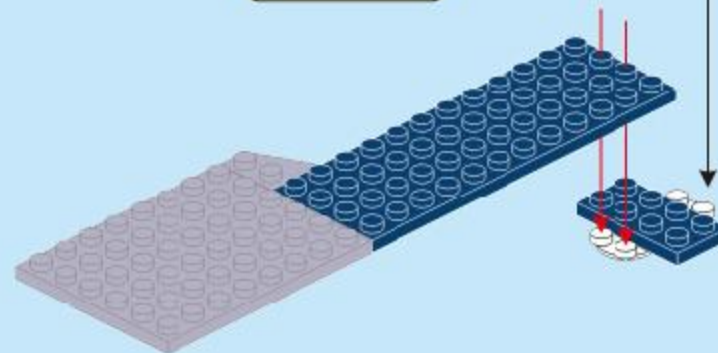
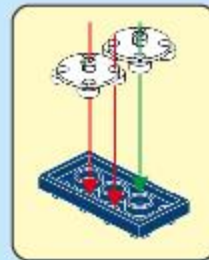

21

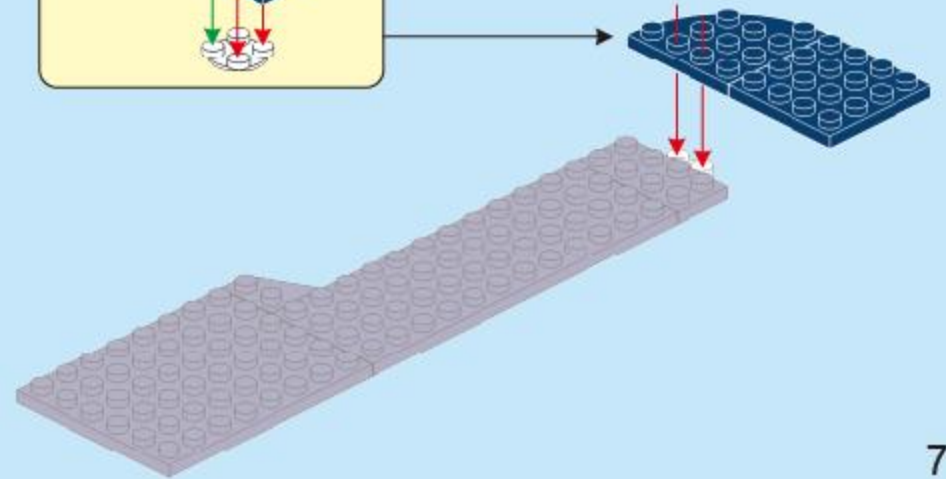
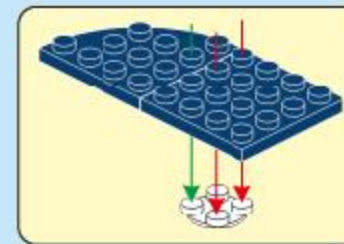

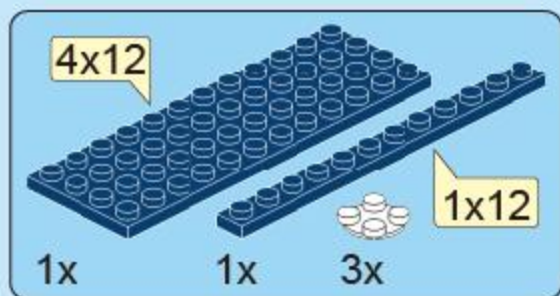

22

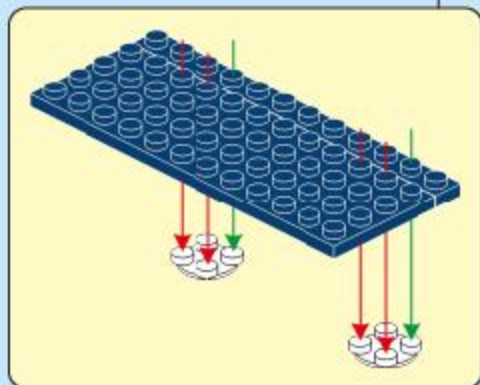

23

22

18

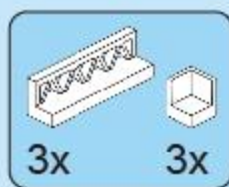
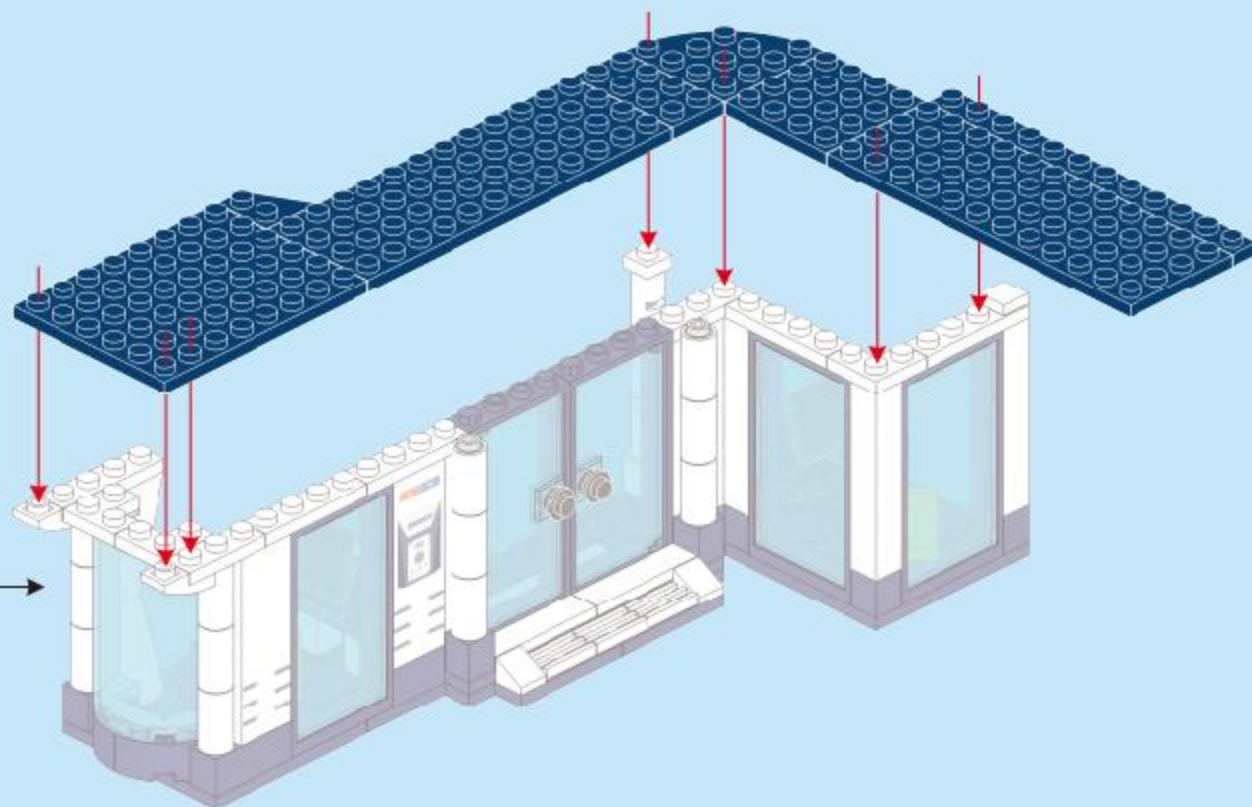

24





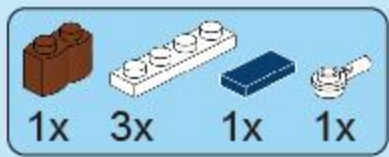

25

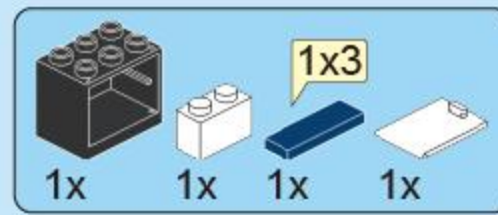
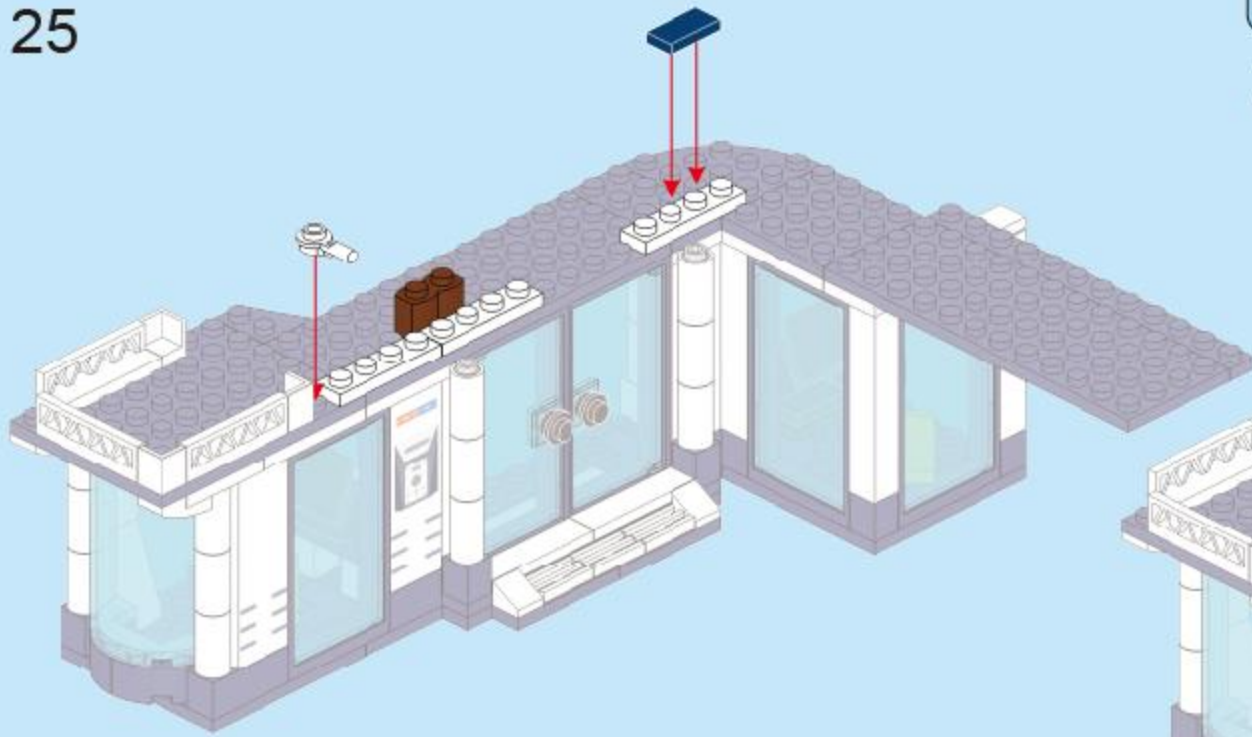

26

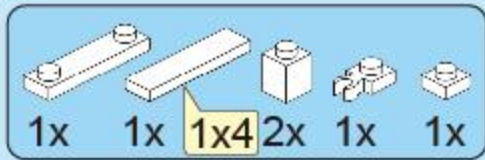
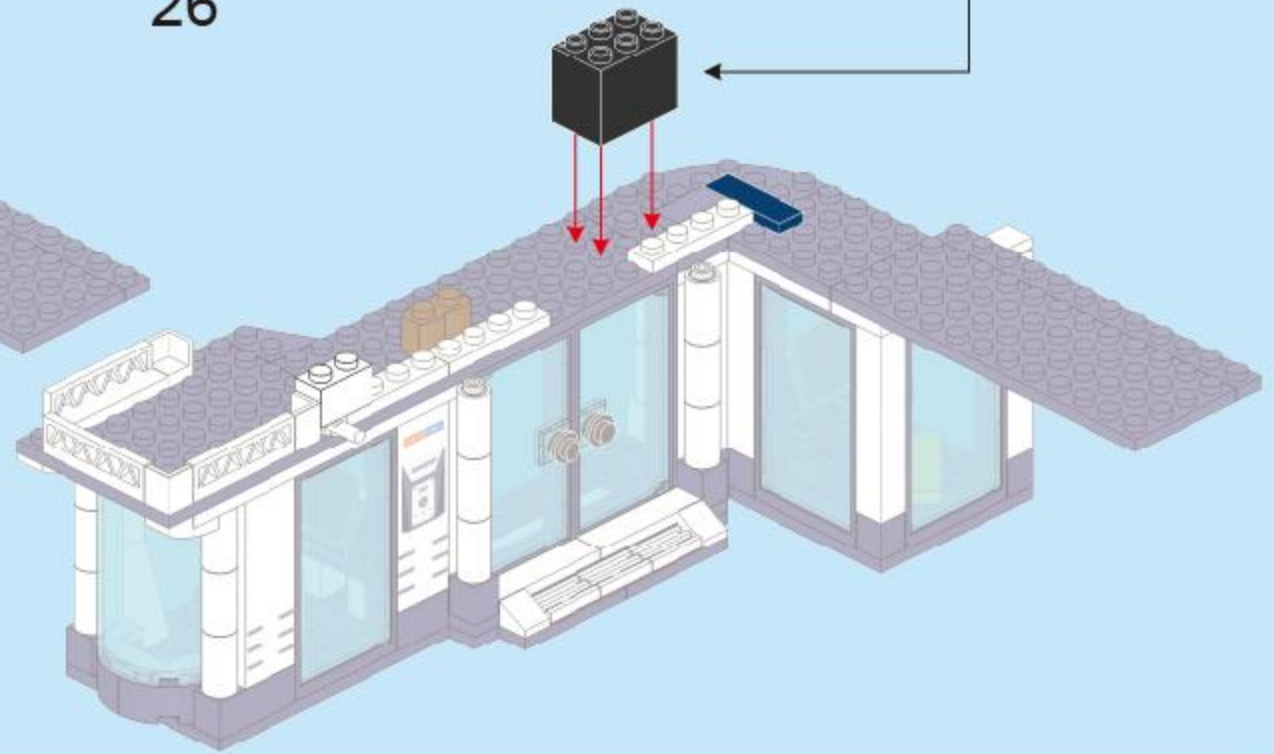

27

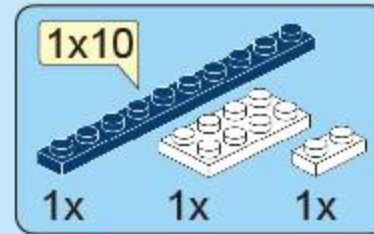
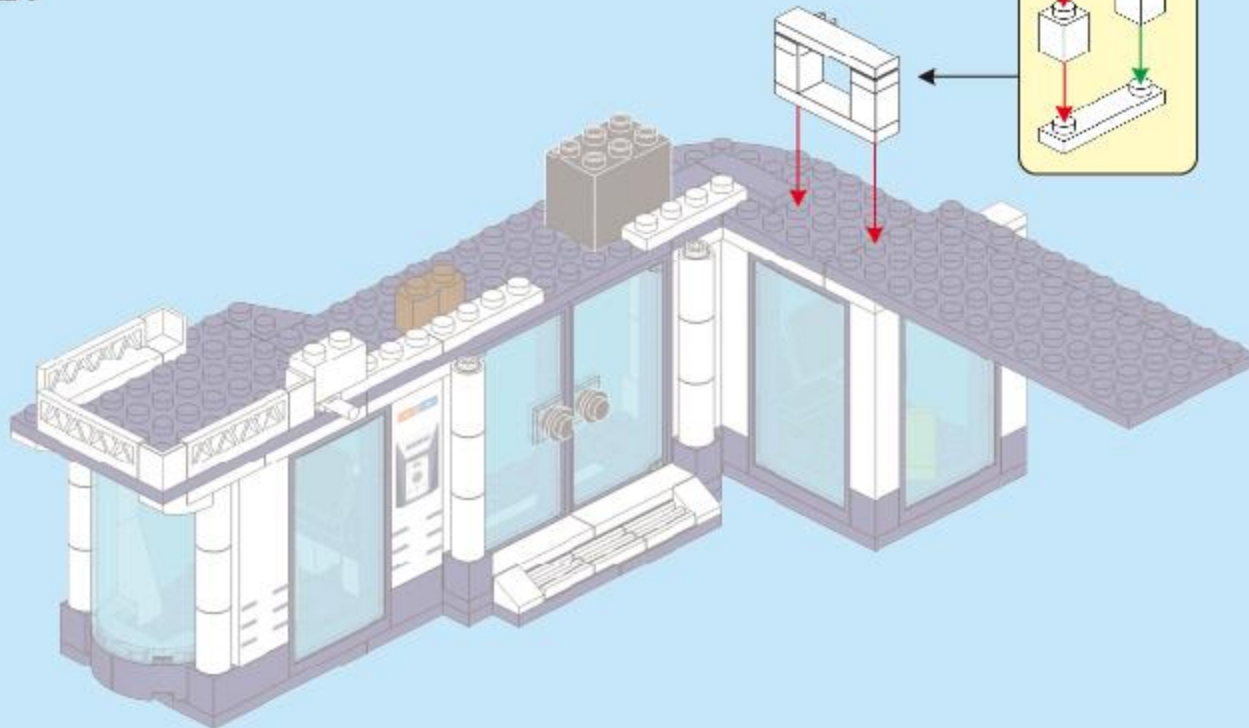

28

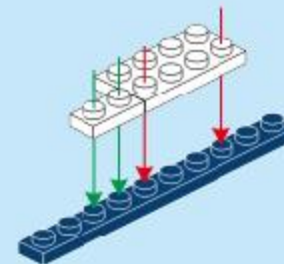

29



30

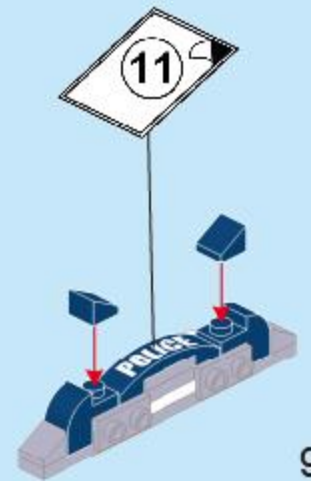

31

27

30

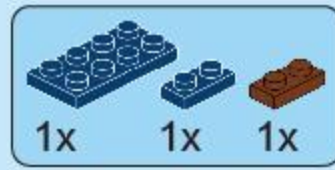

32



33



34

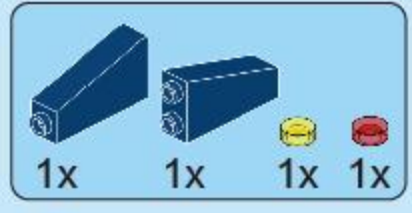
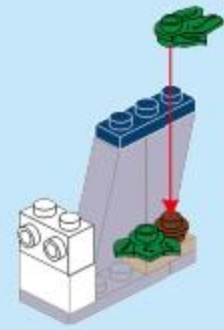
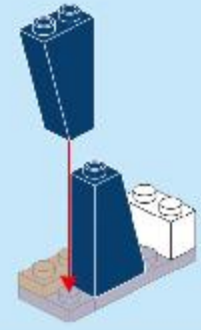
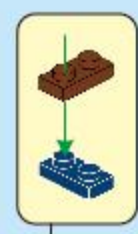

35

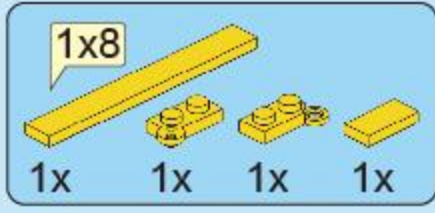

36

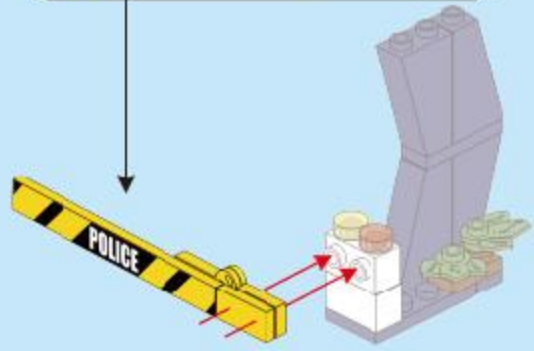
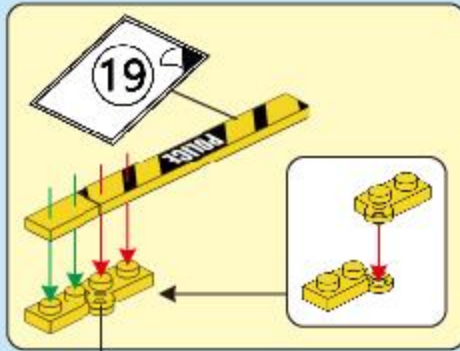

37

31



36

10

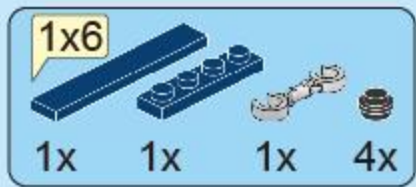

38

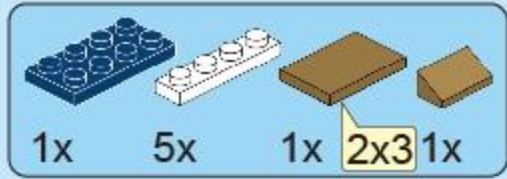
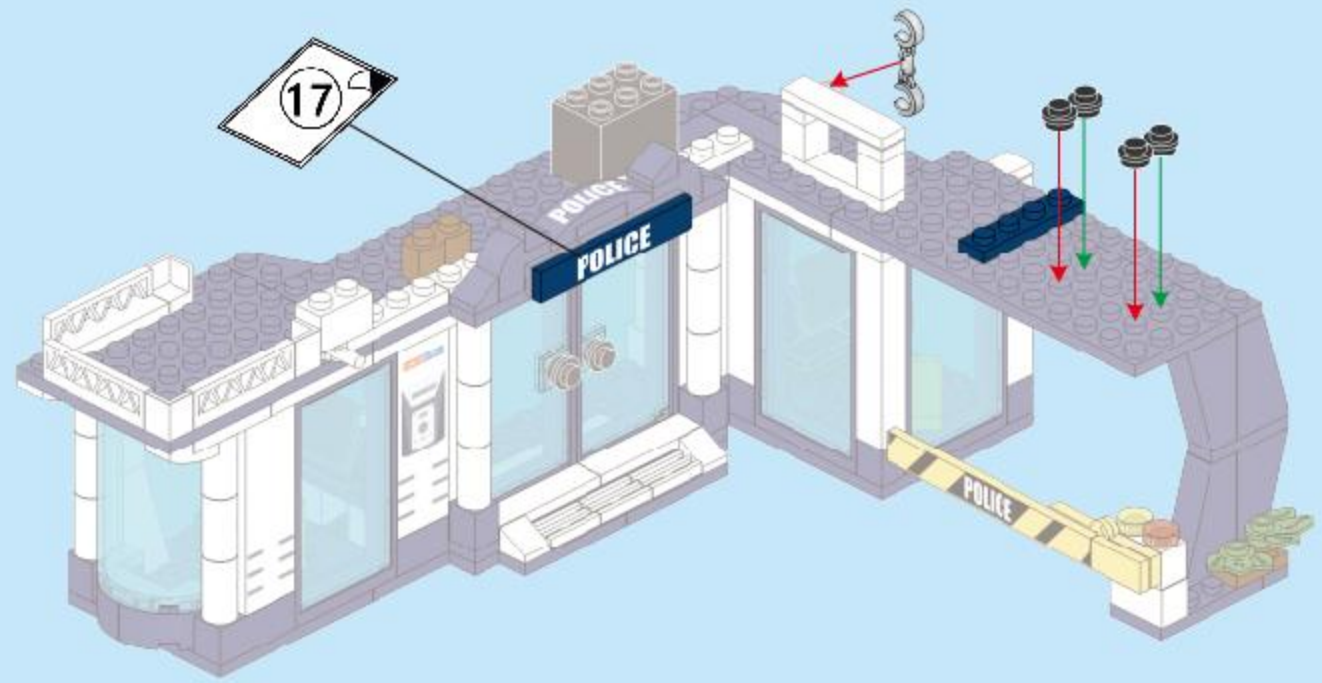

39

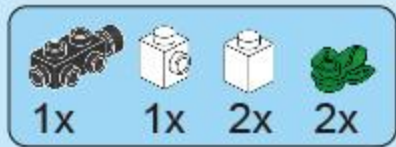
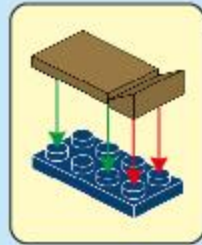

40

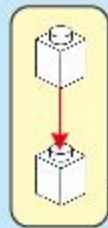

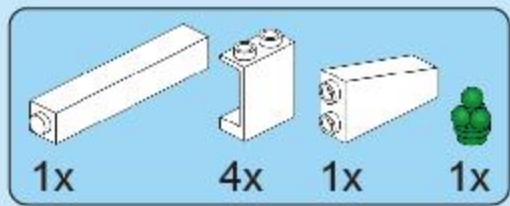

41

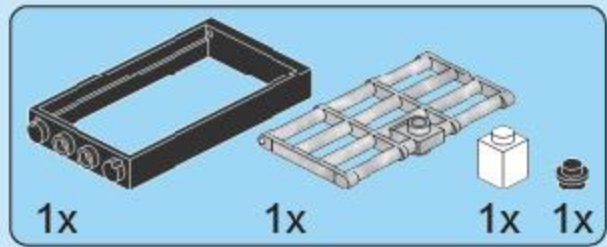
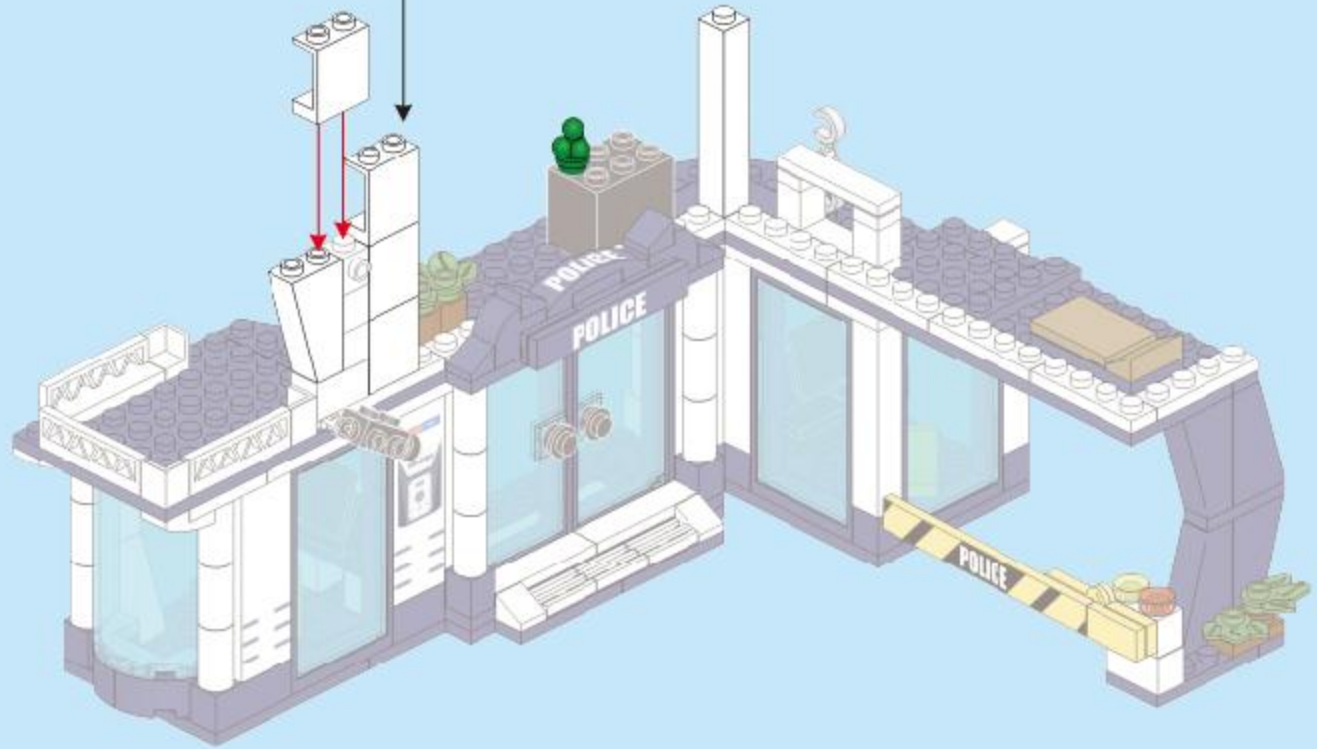
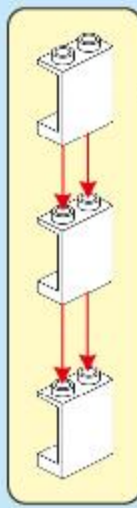

42

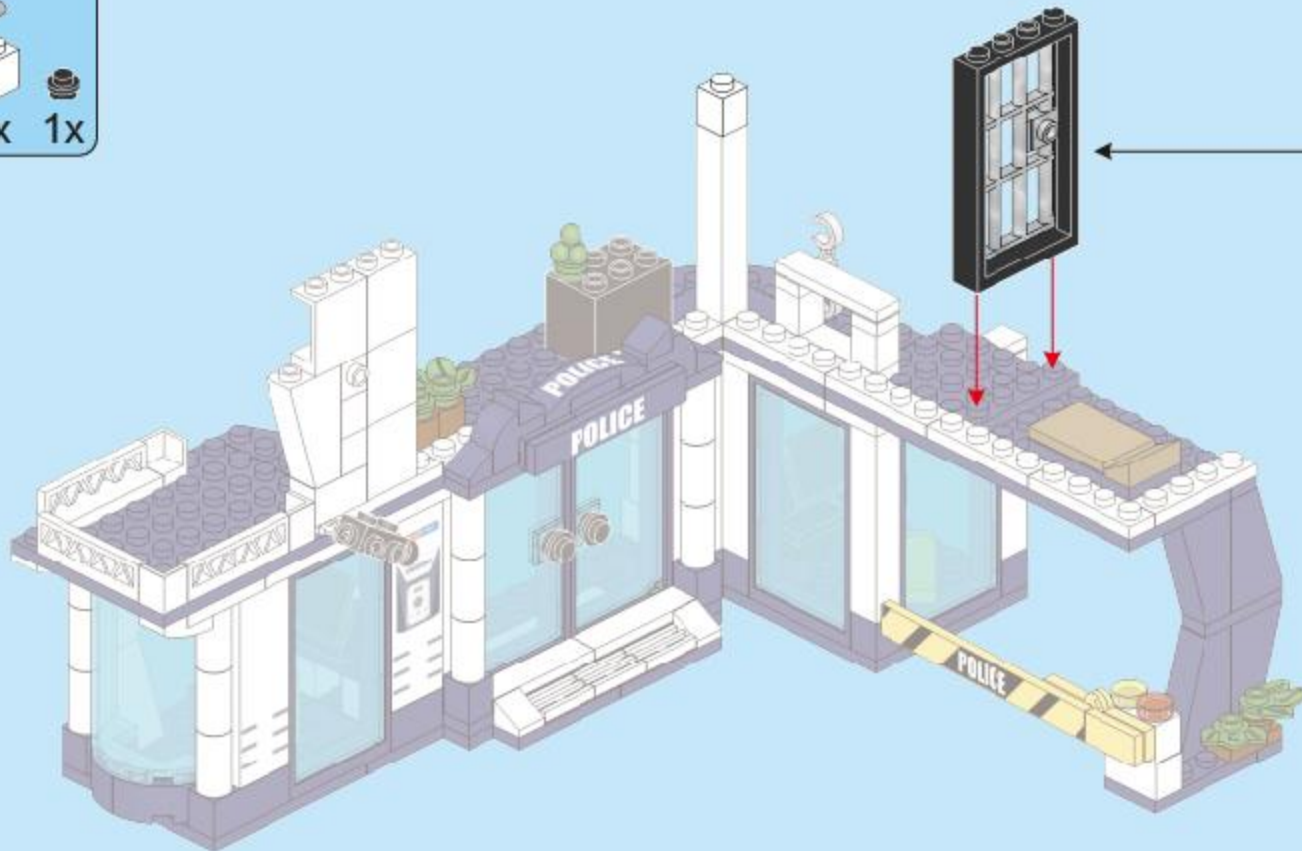
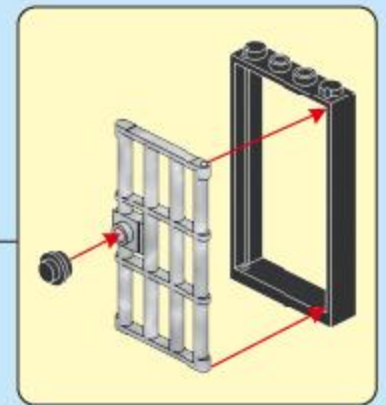

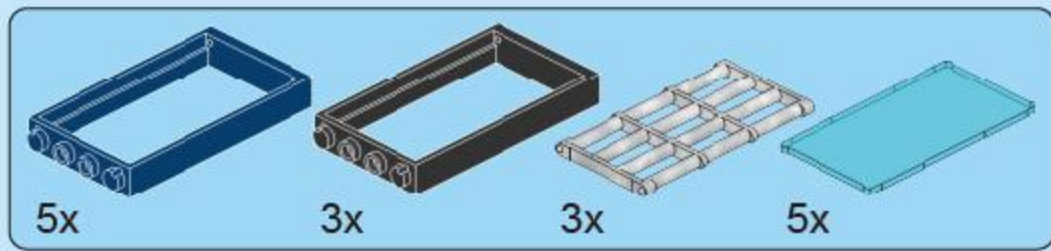

43

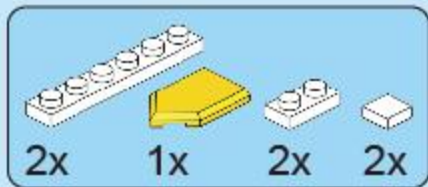
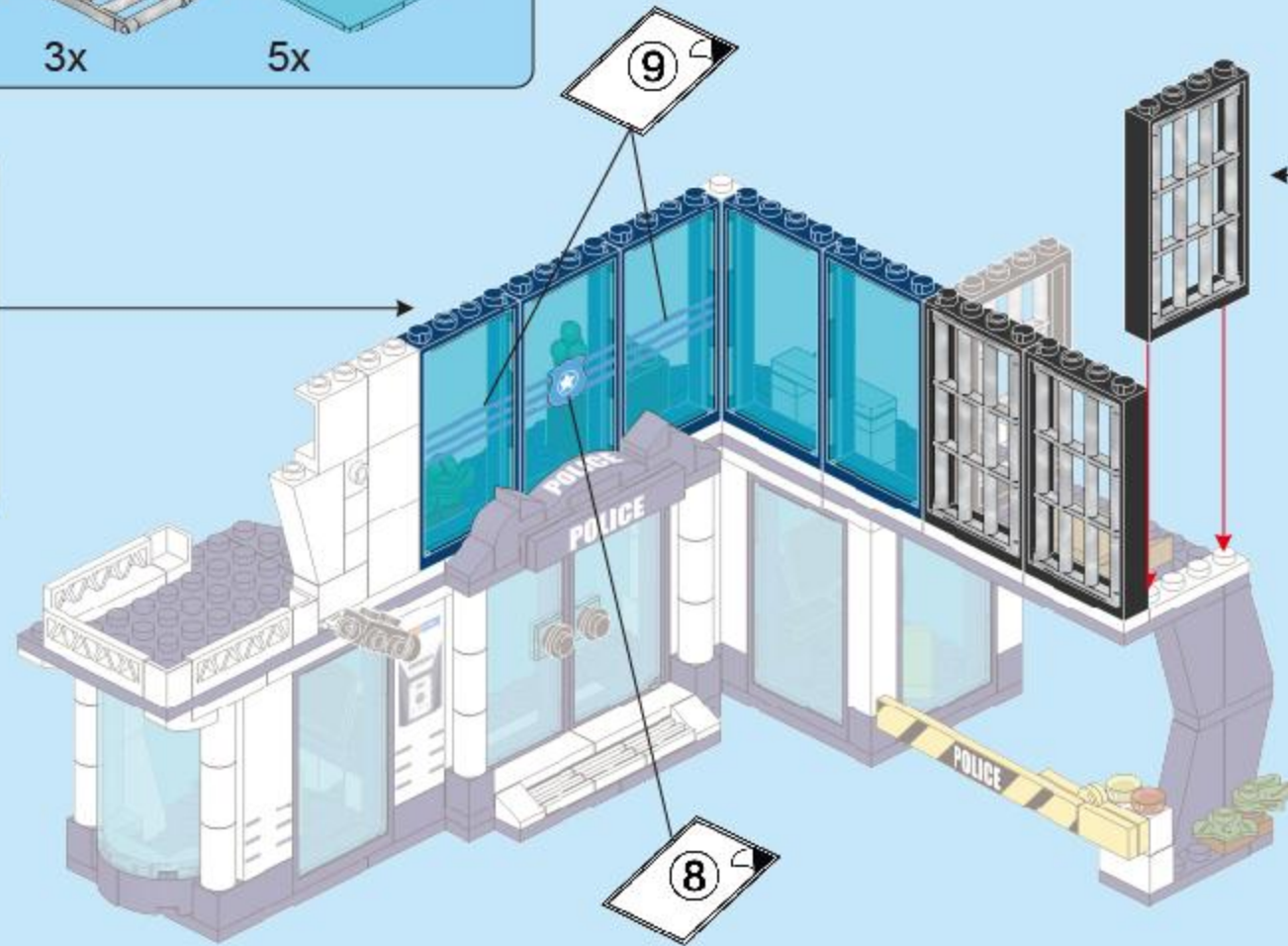
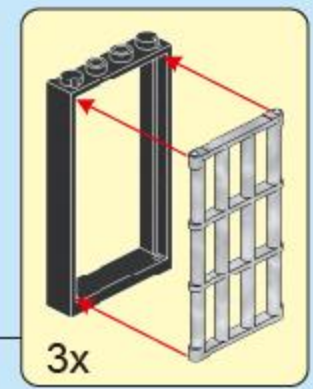
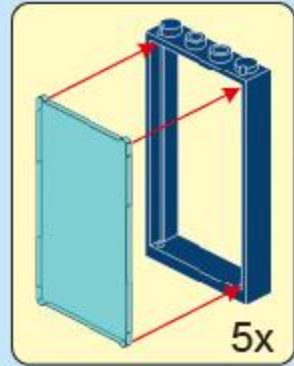

44

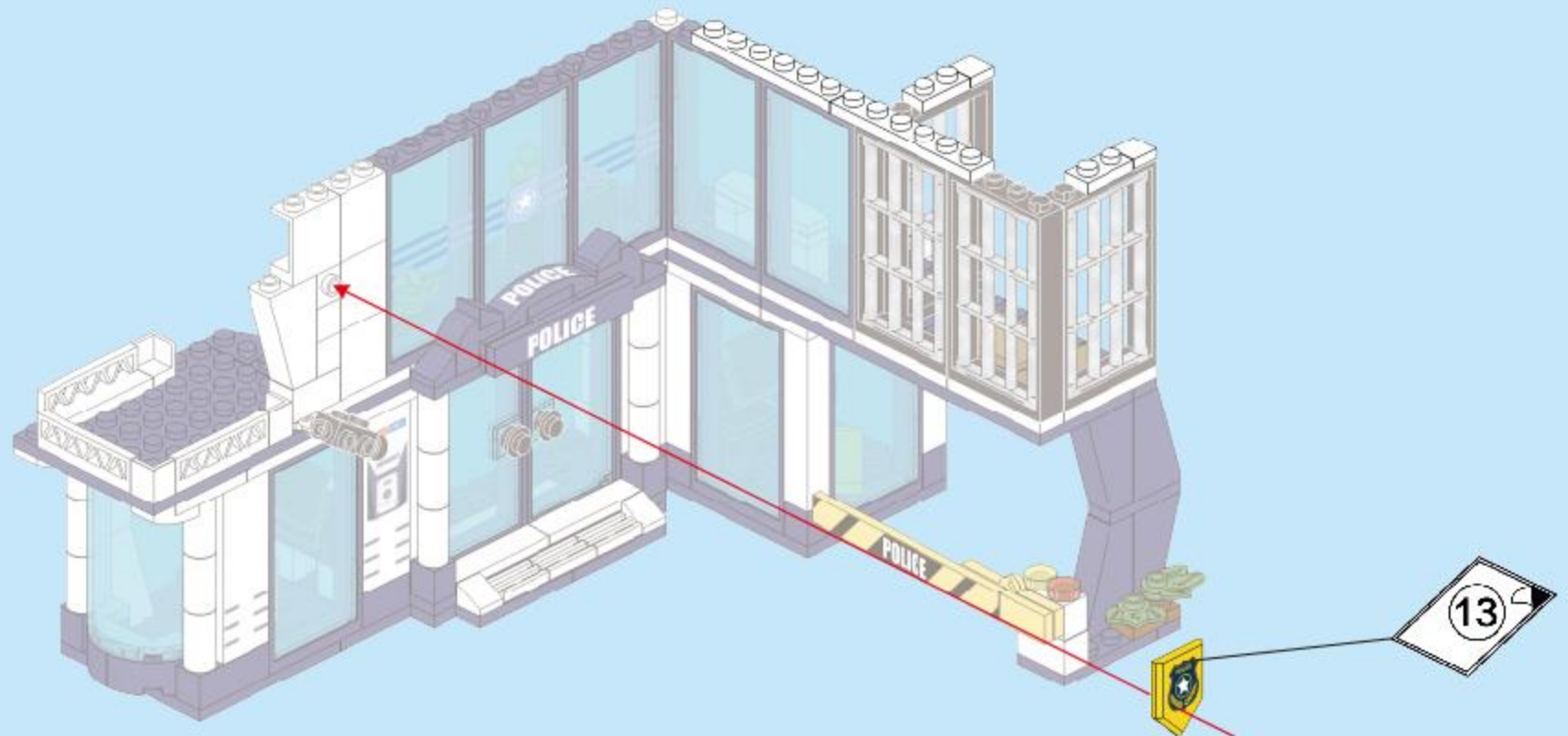

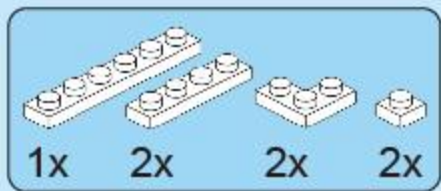

45



46

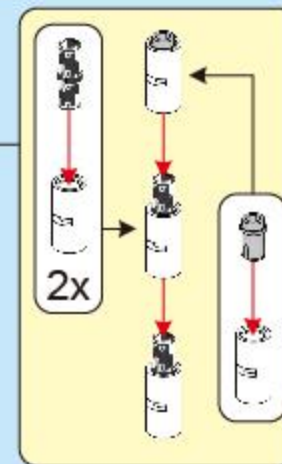
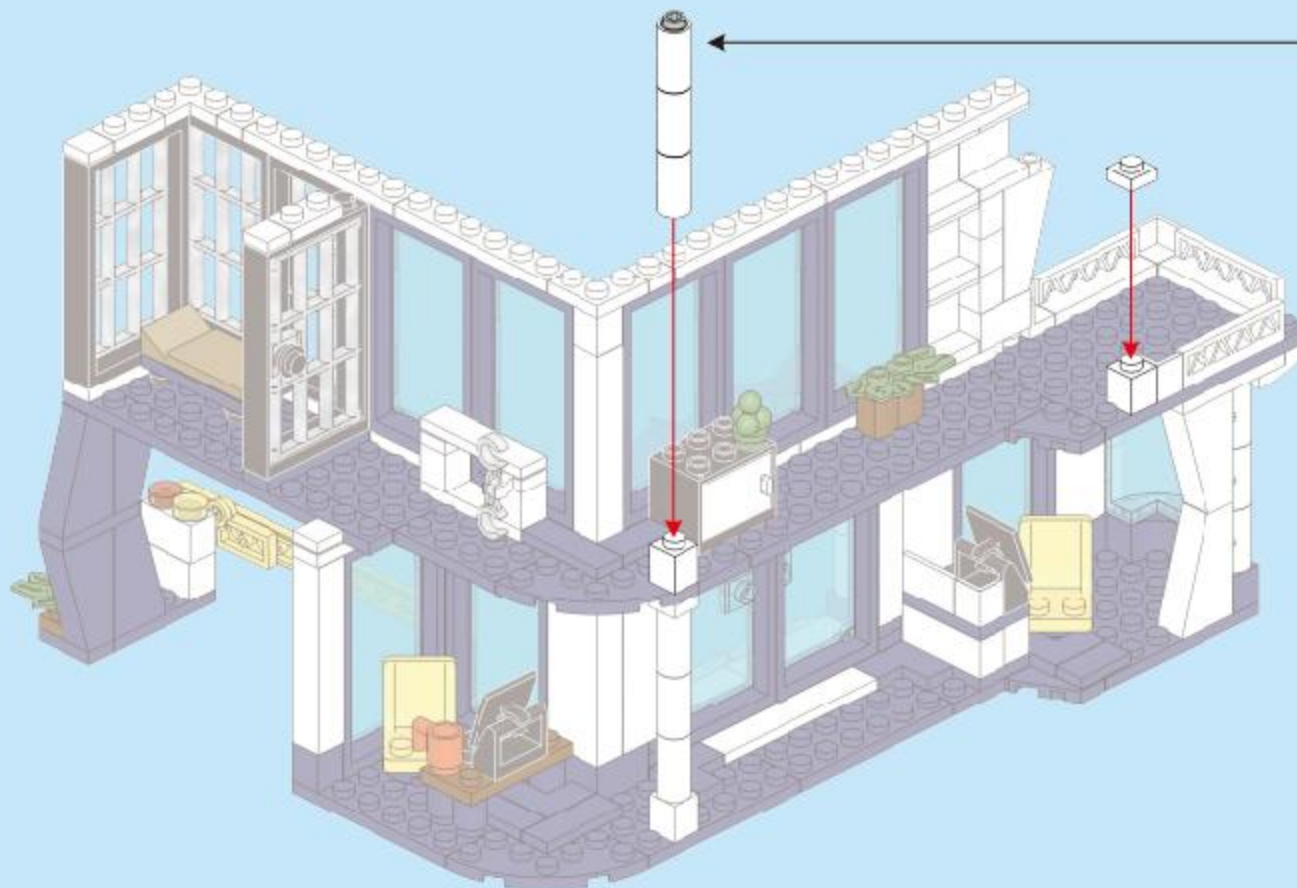



47

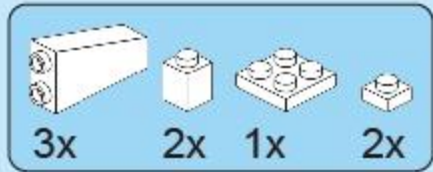
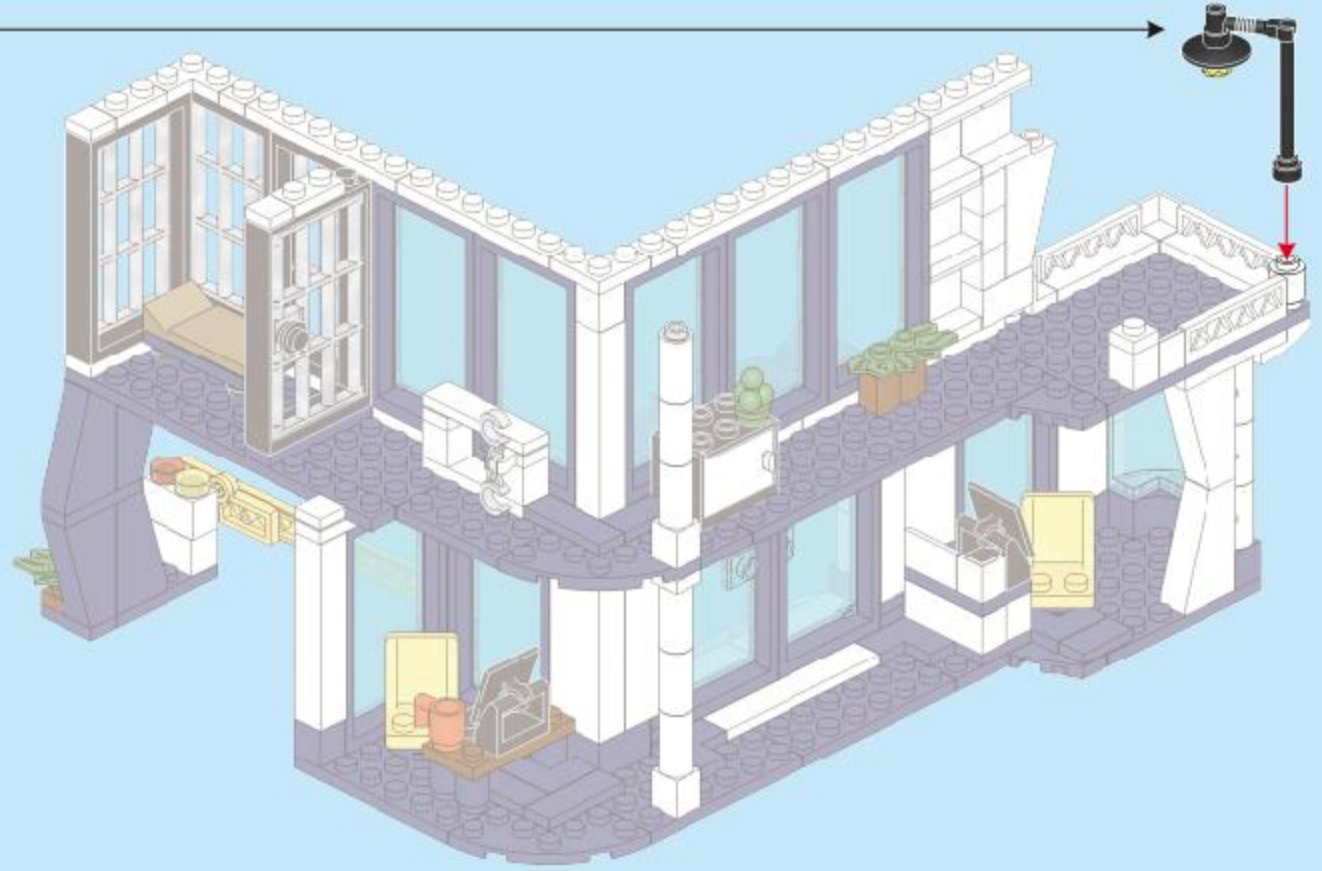
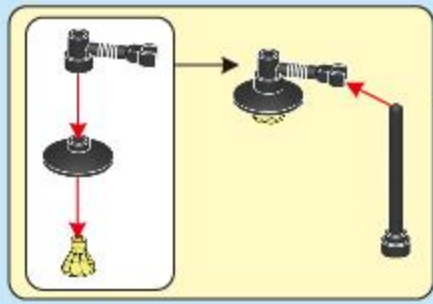

48

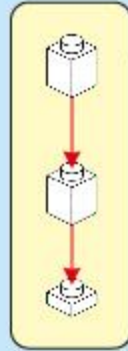

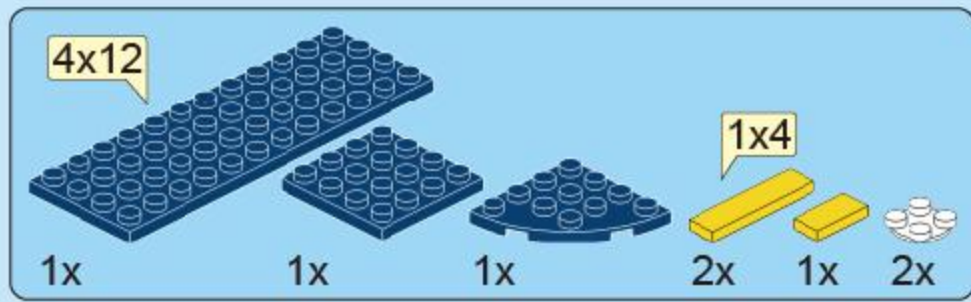

49

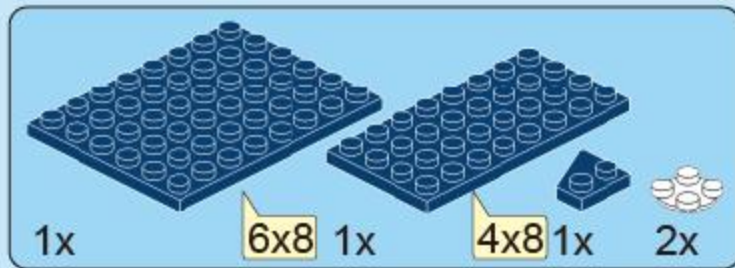
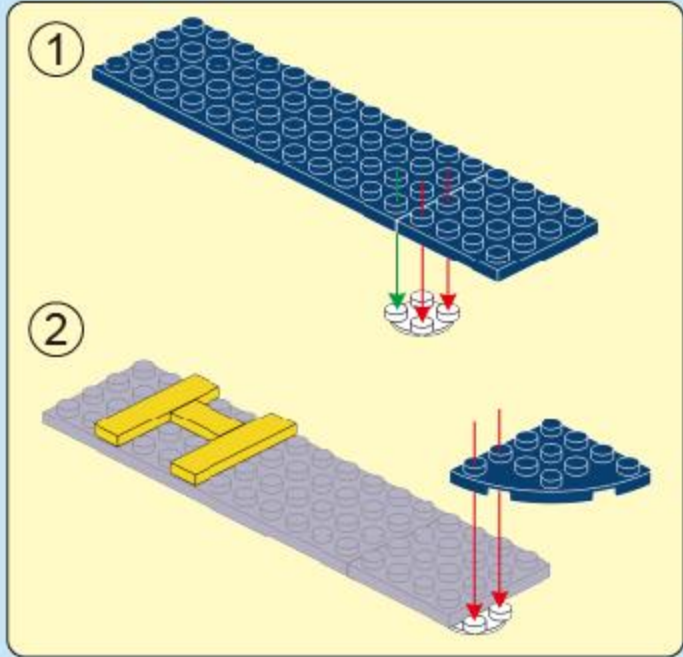

50

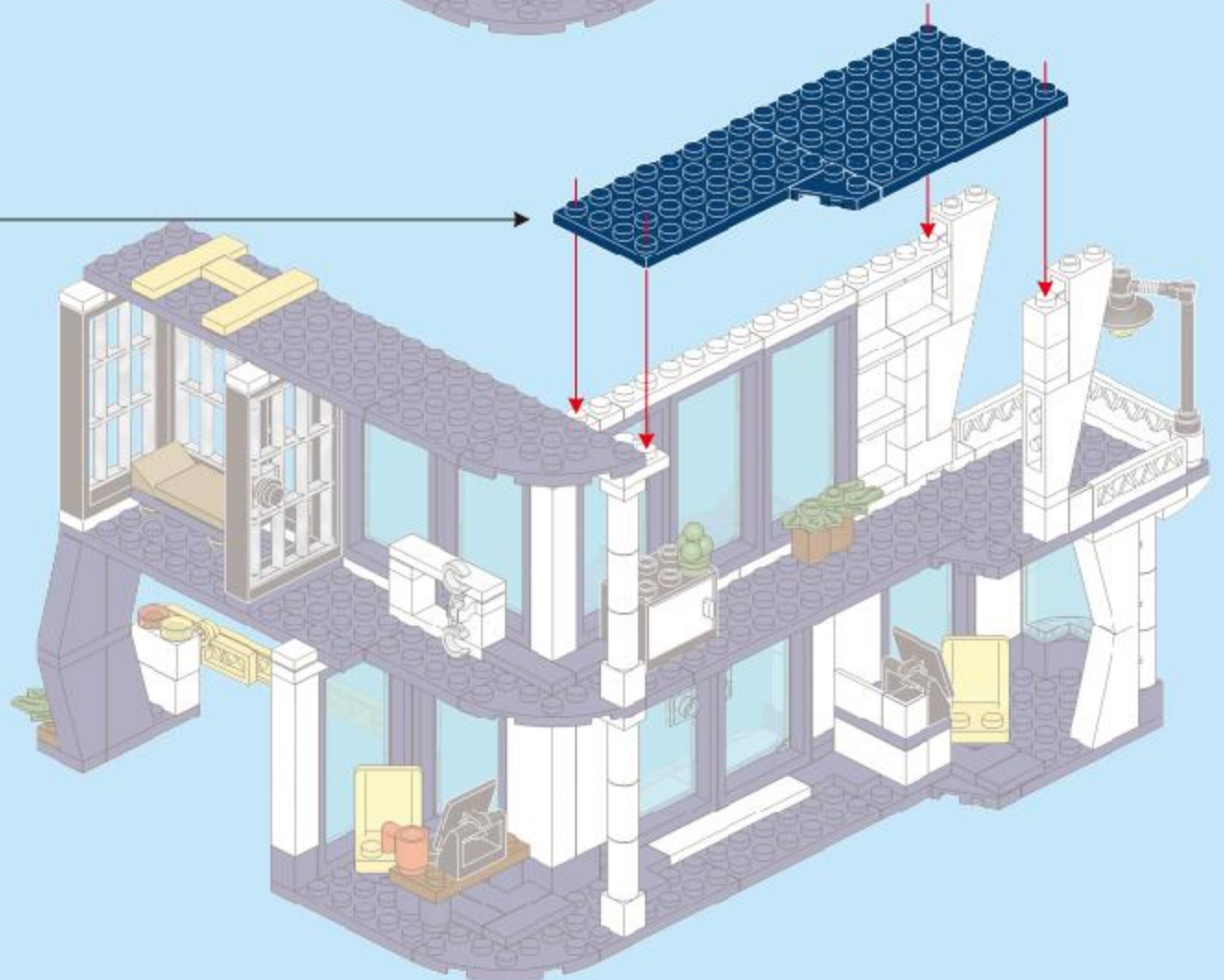
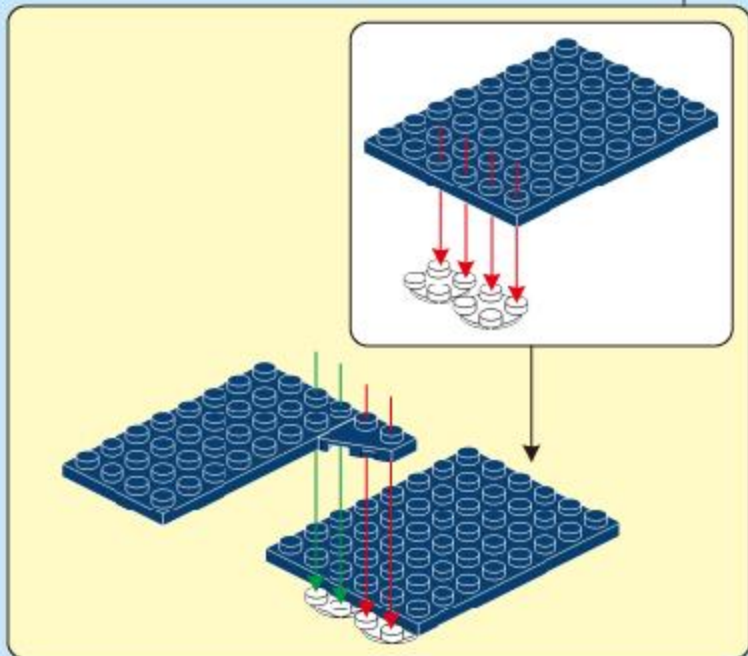



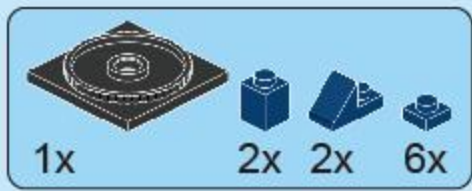

51

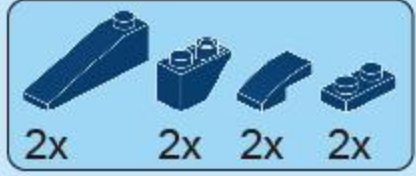
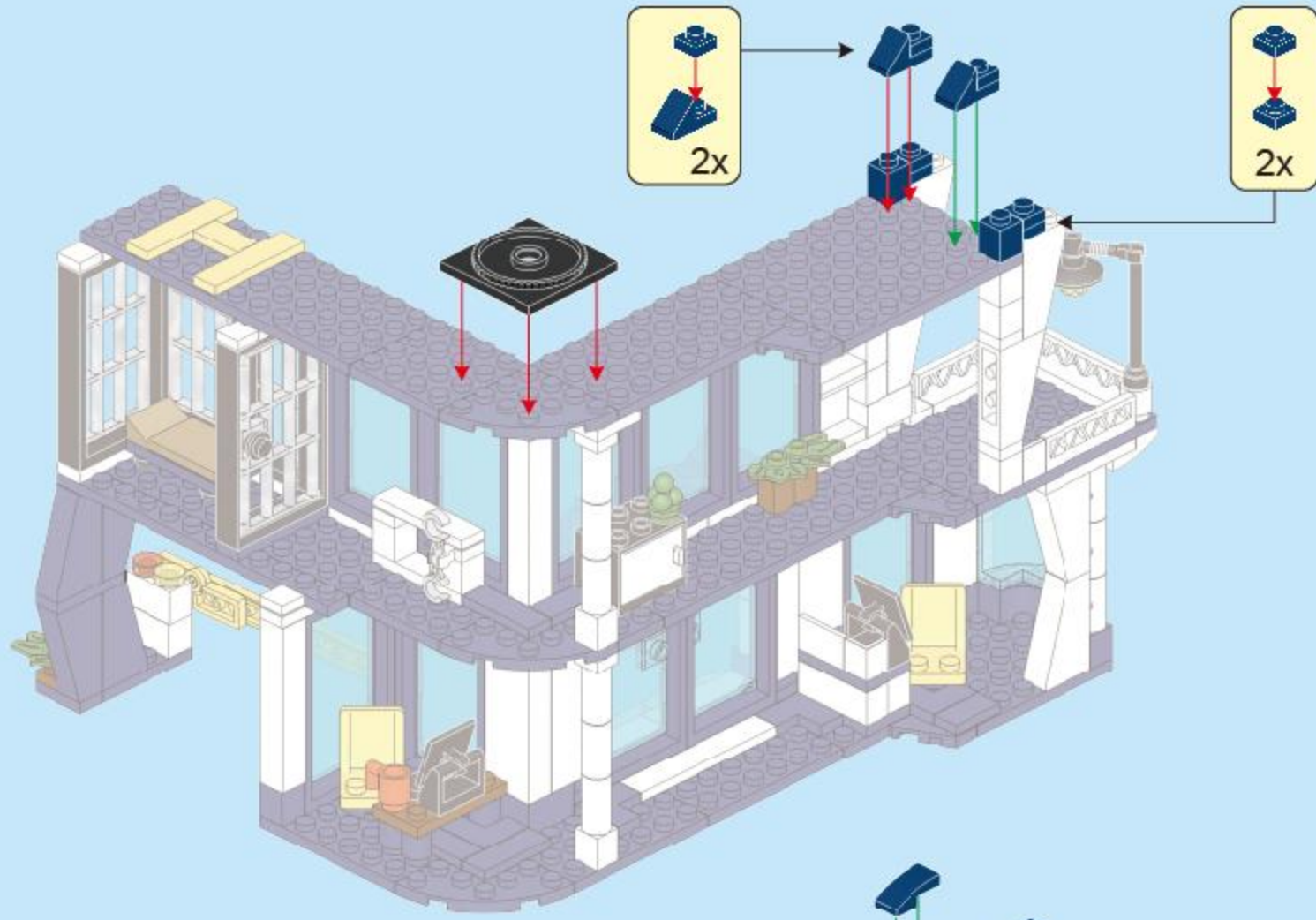

52



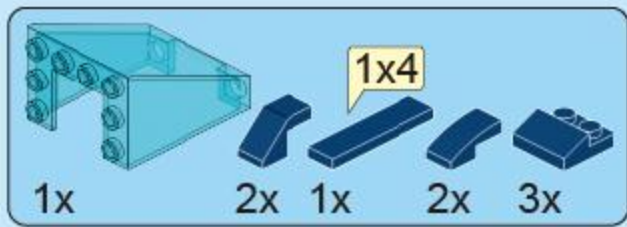

53

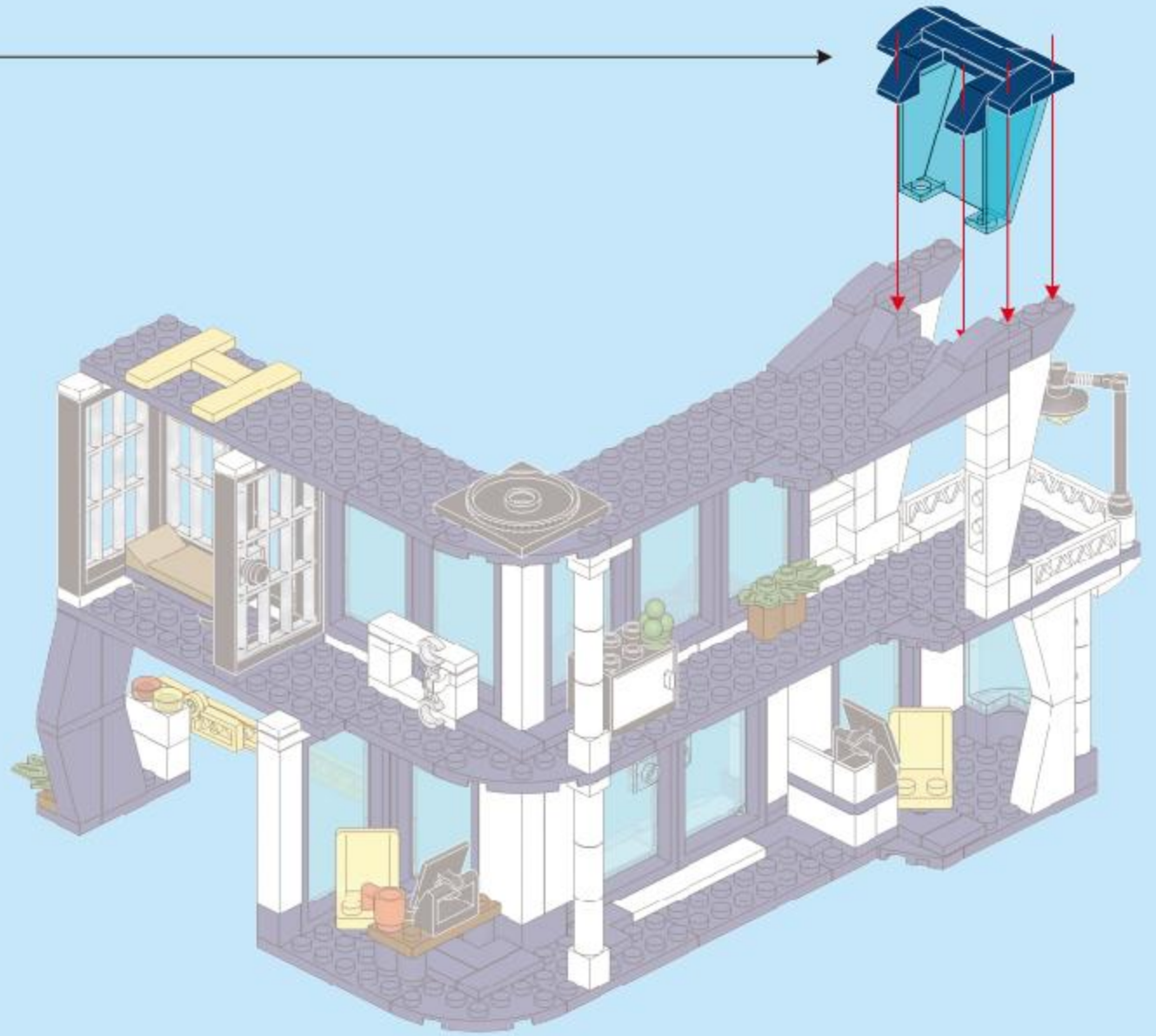
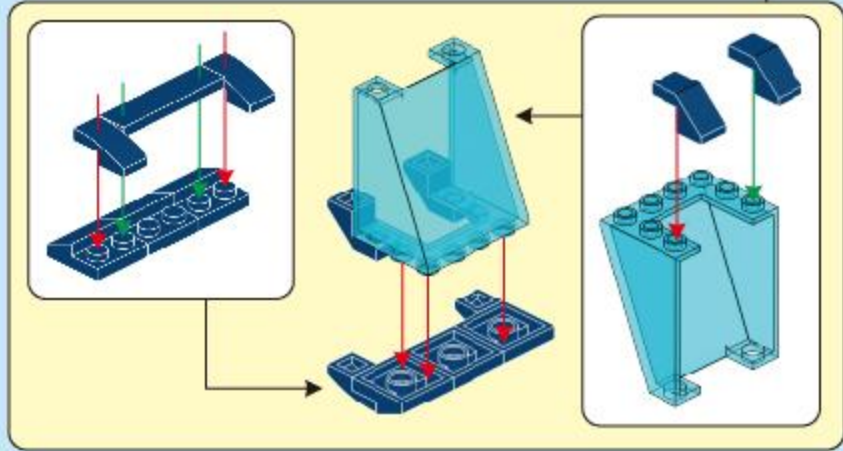

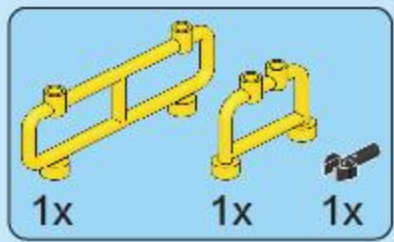

54



55

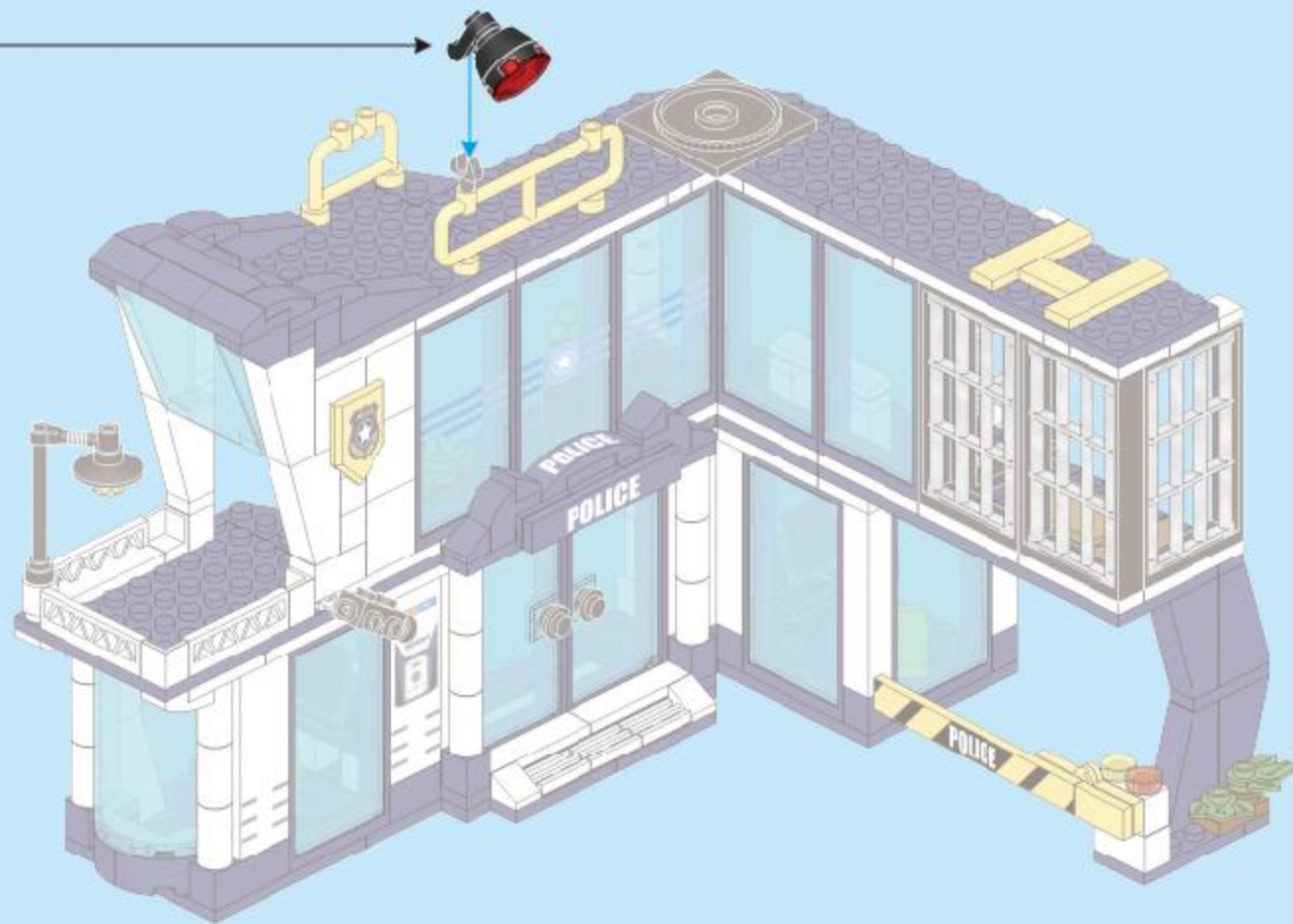

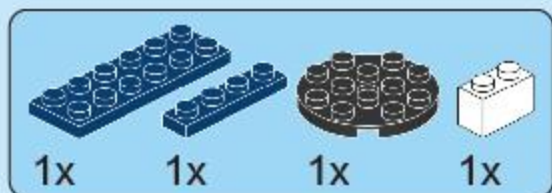

56

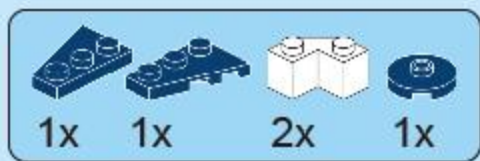

57

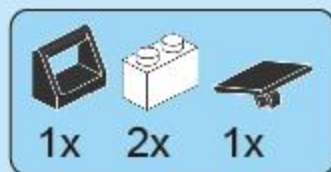

58

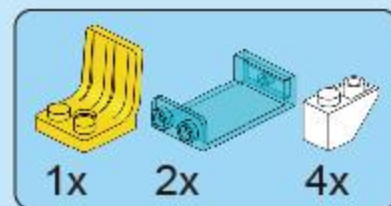

59

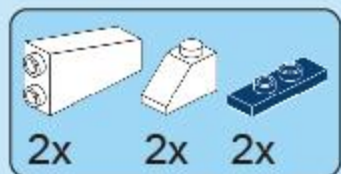
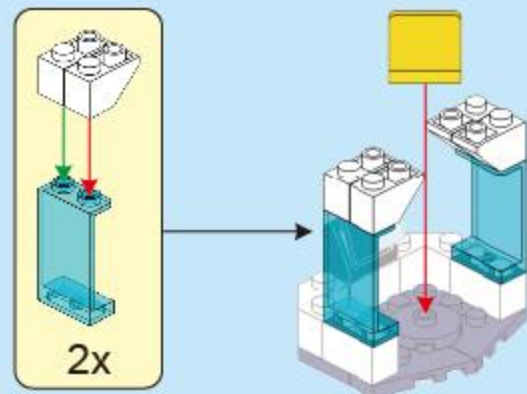
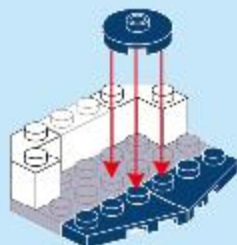
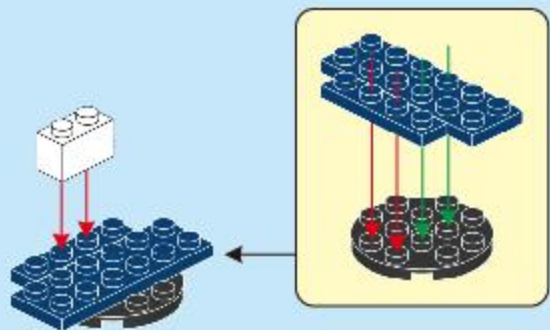

60

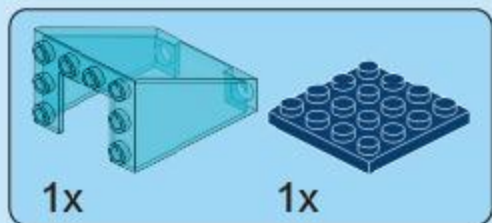

61



62



63



64

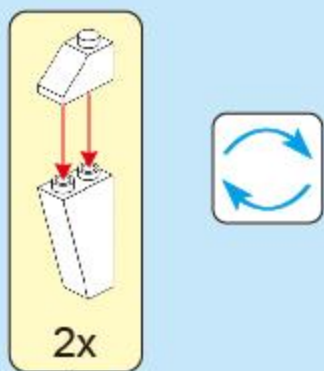

20

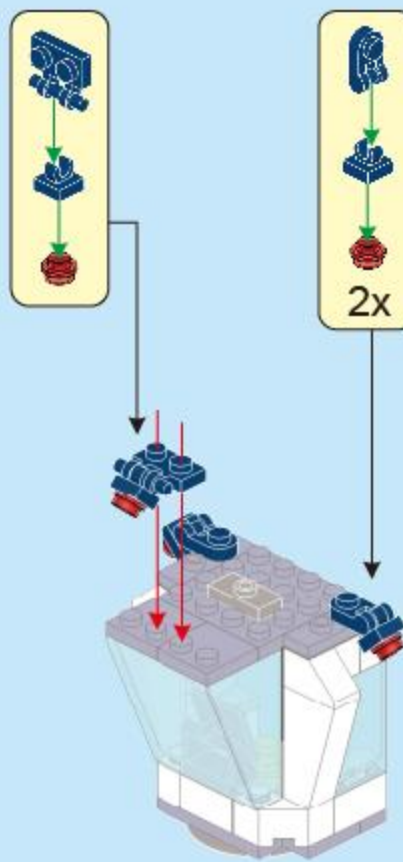
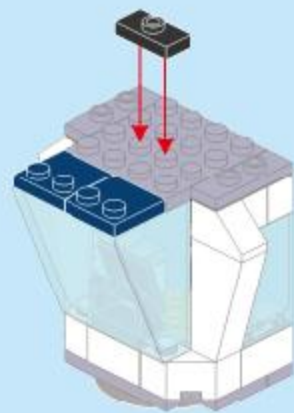
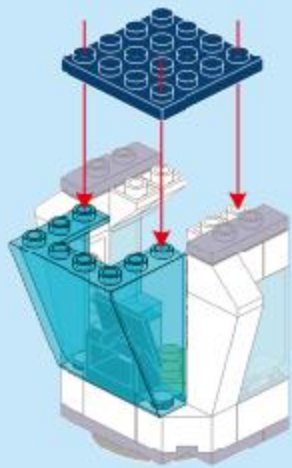
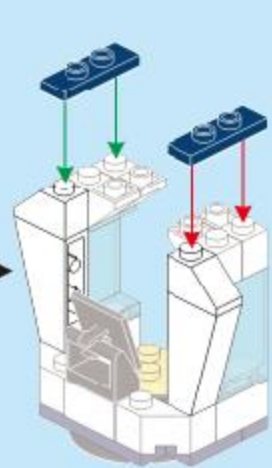

65

64

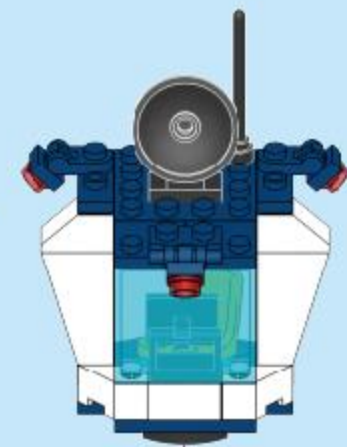

55

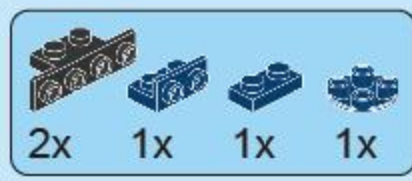

66

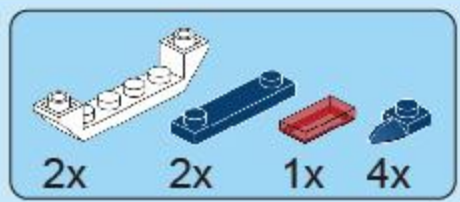
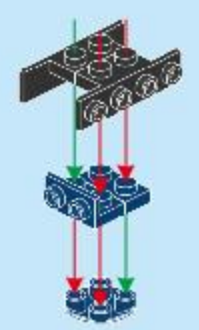

67

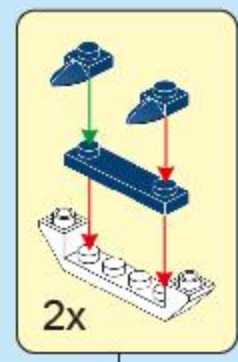
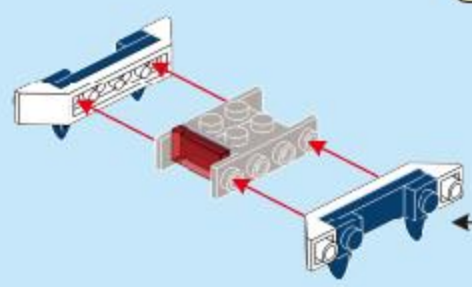

68

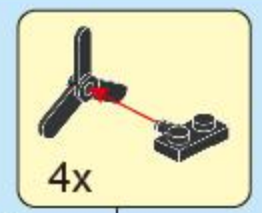
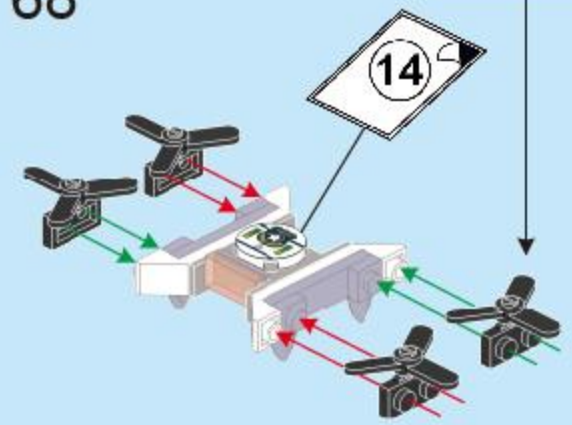

69

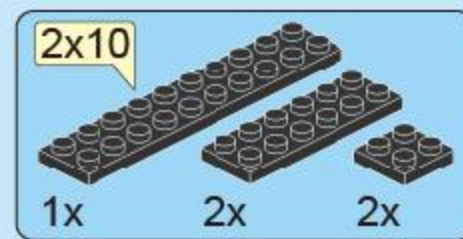
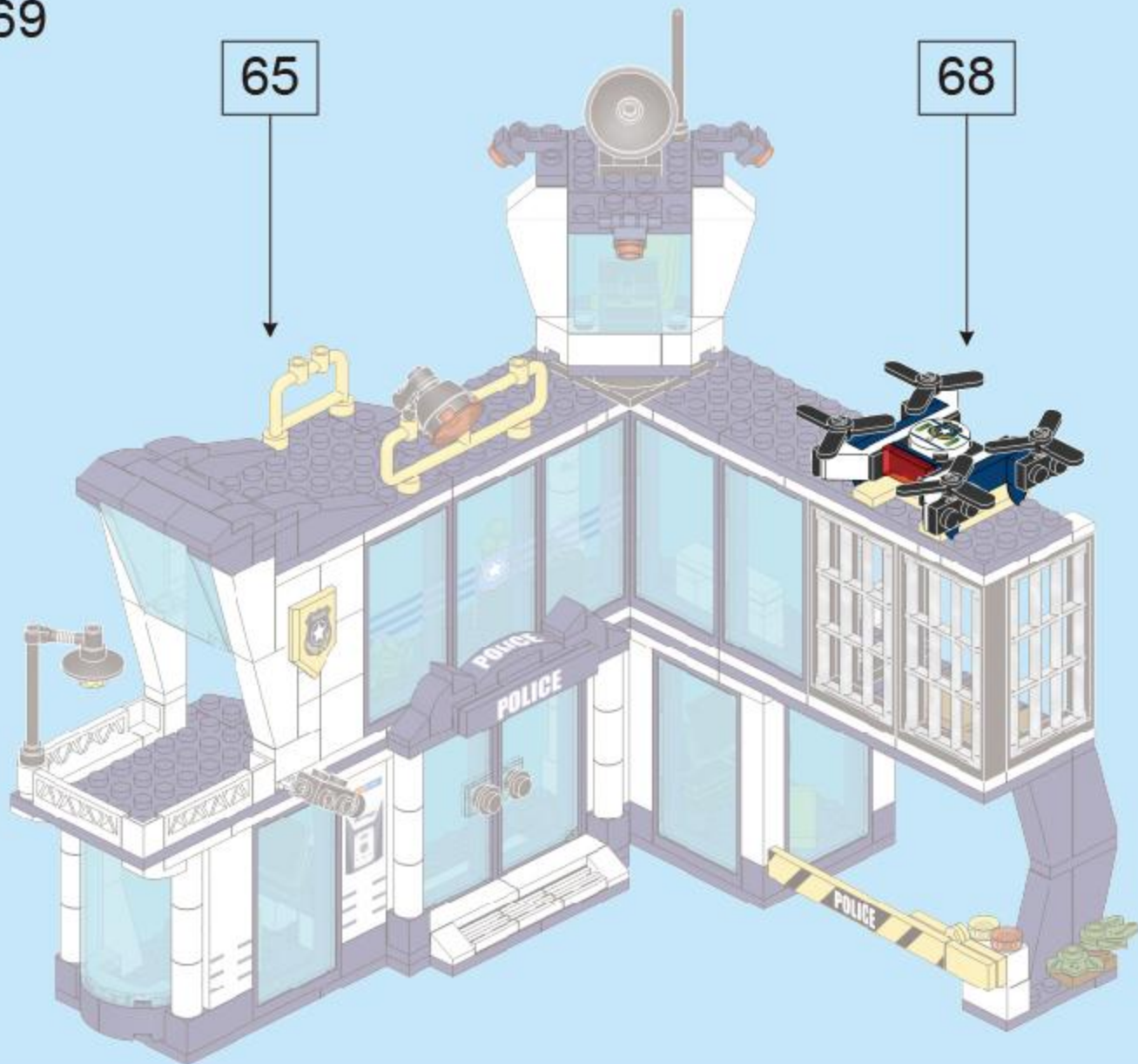

70



71

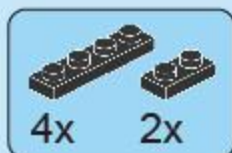
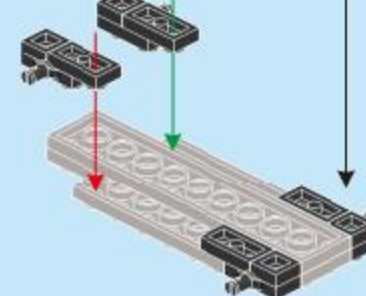
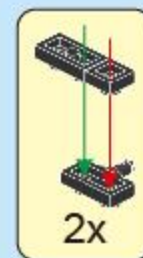
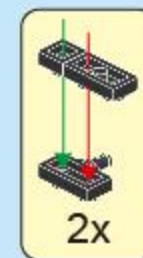
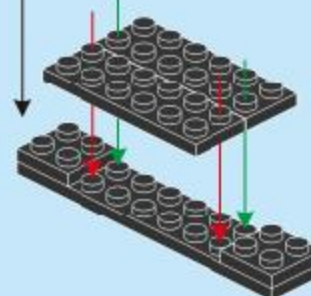
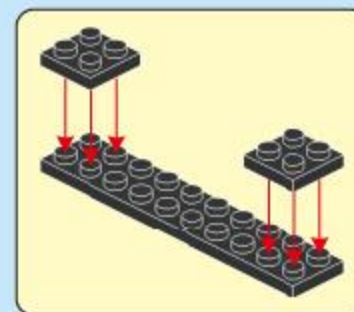

72

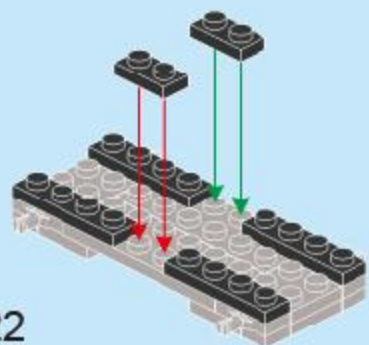

22



73

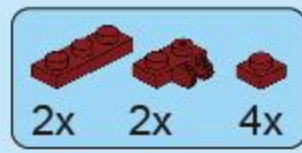
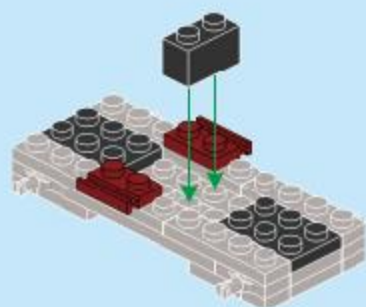

74

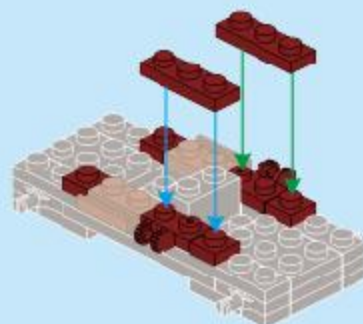

75

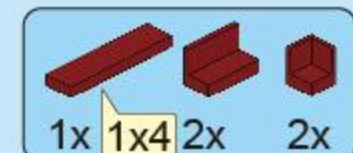
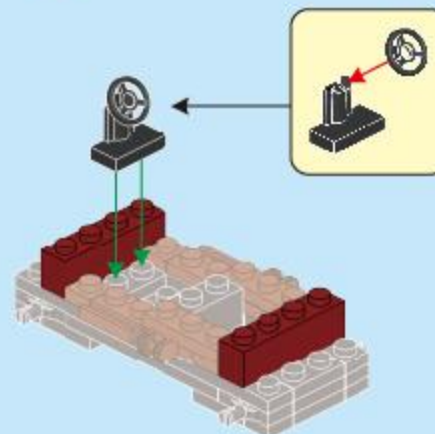

76

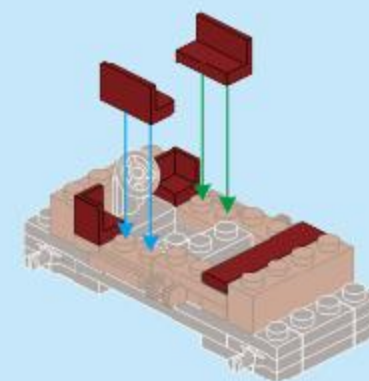

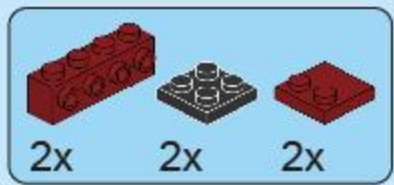

77

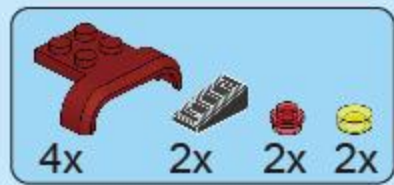
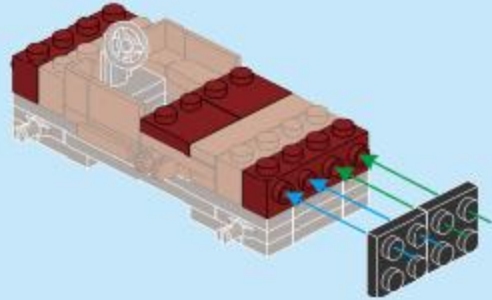

78

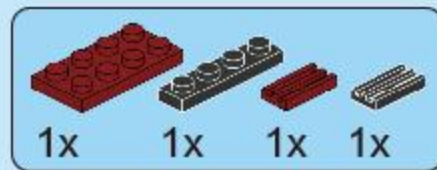
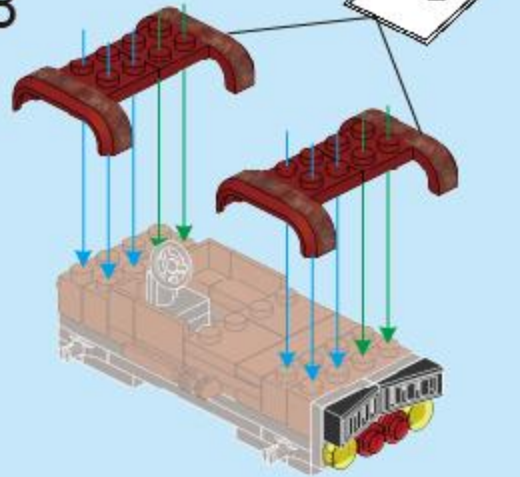

79

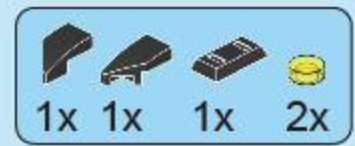
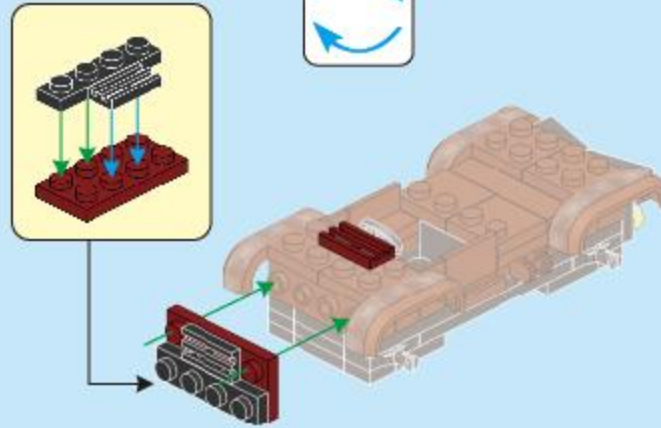

80

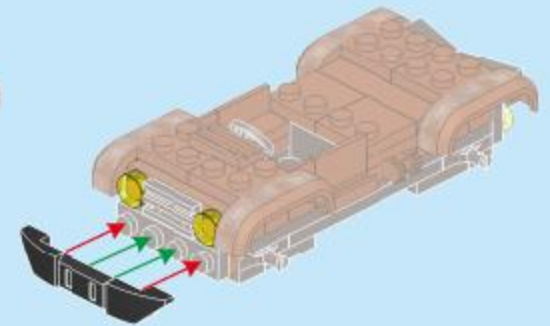

81

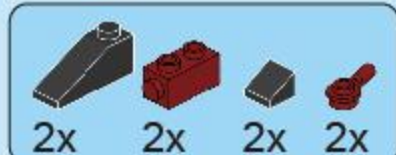
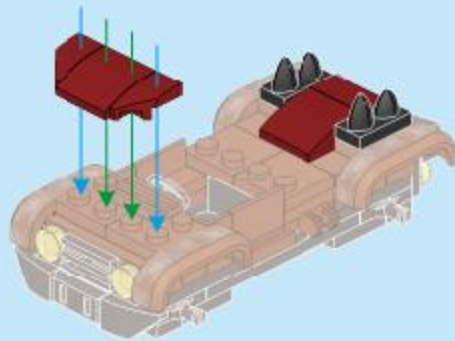

82

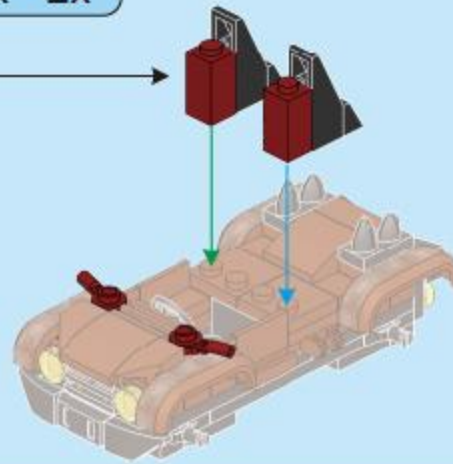
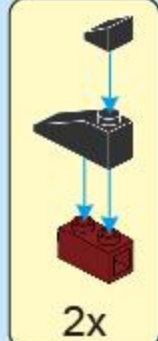

83

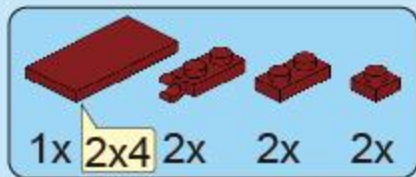
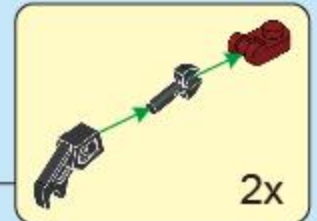
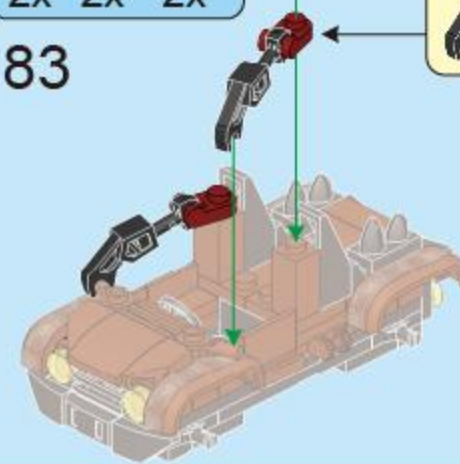

84

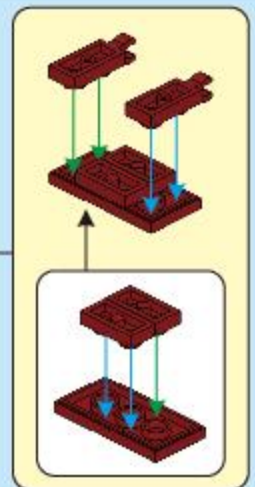
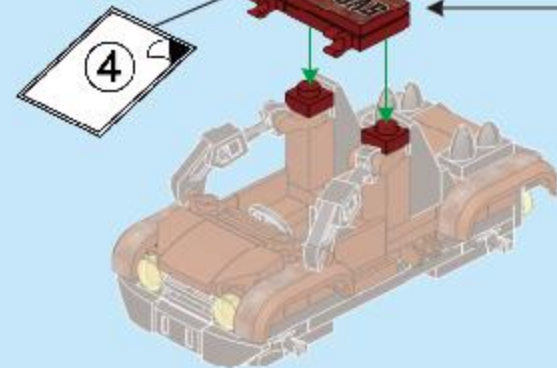

85

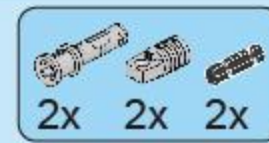
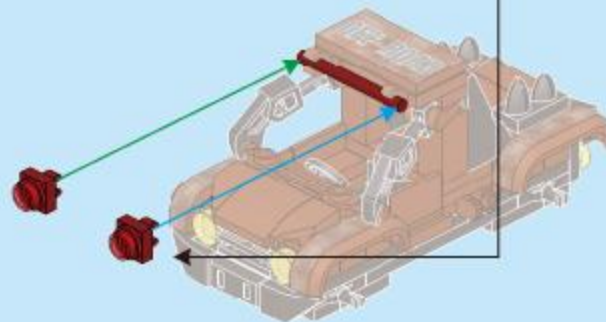

86

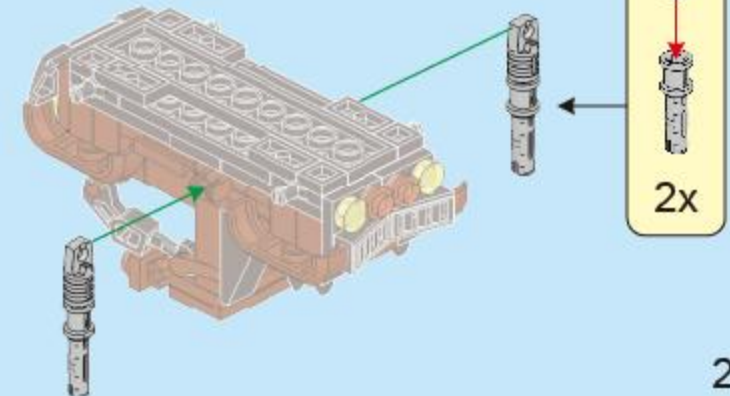



87

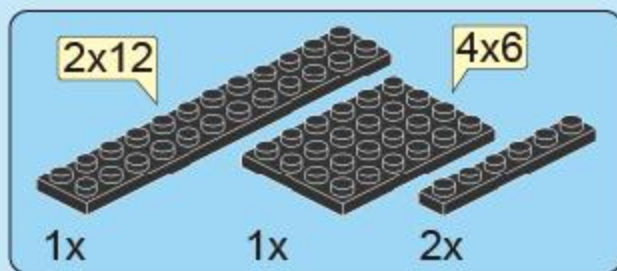
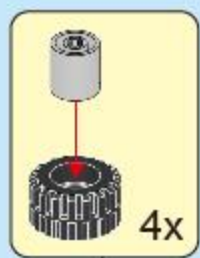
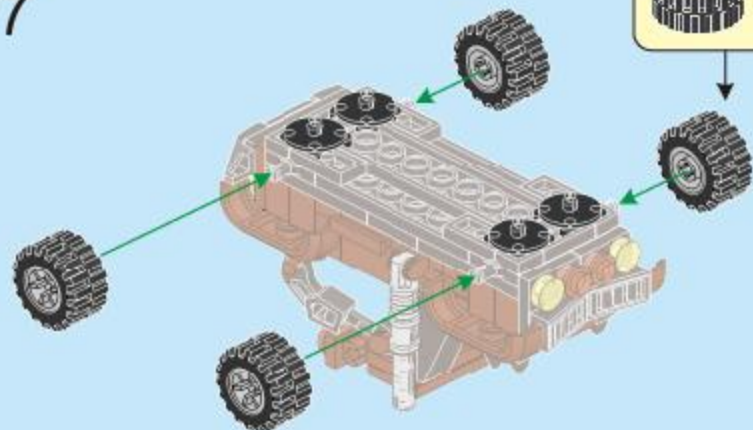

88

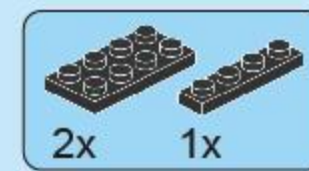
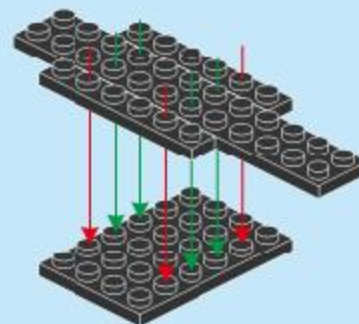

89

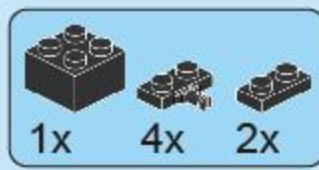
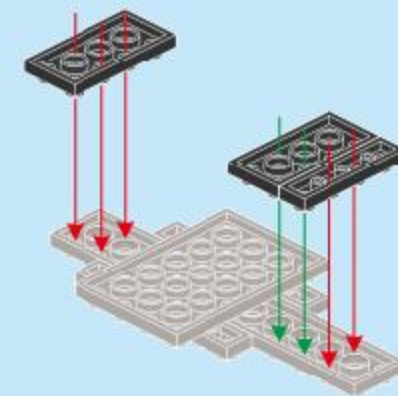

90

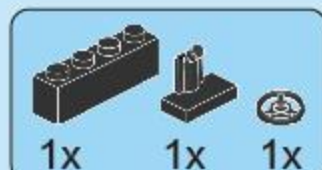
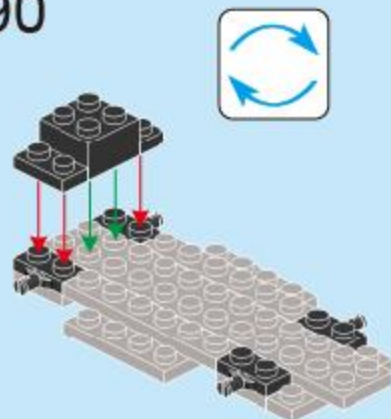

91

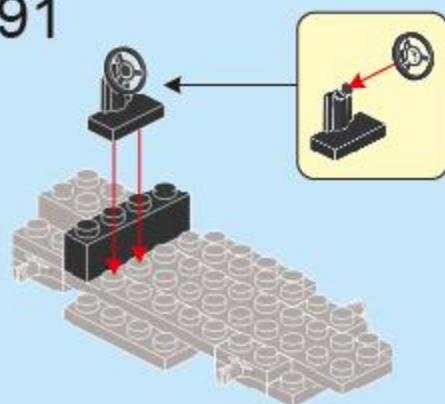

92

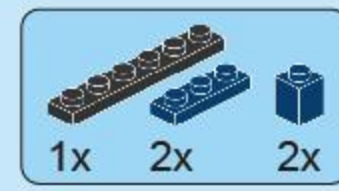
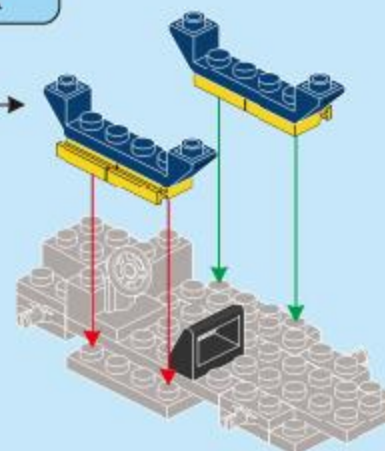
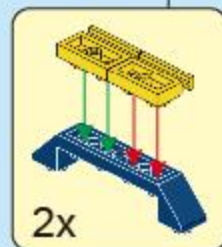

93

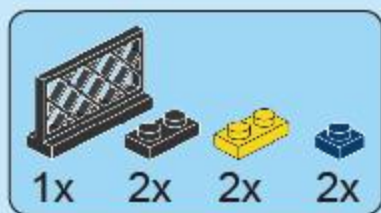
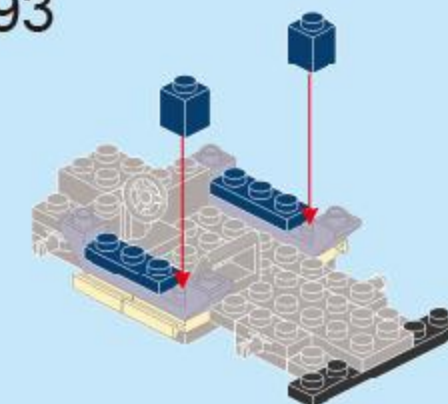

94

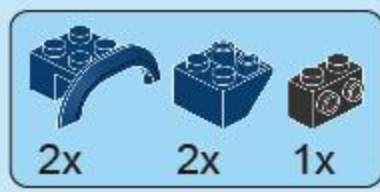
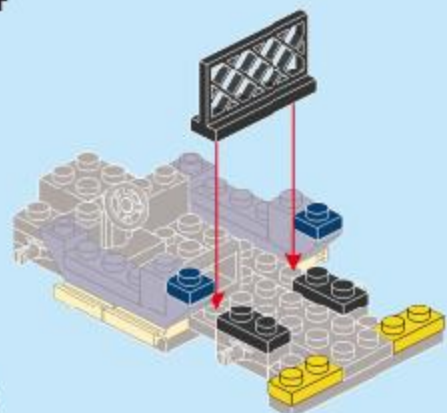

95

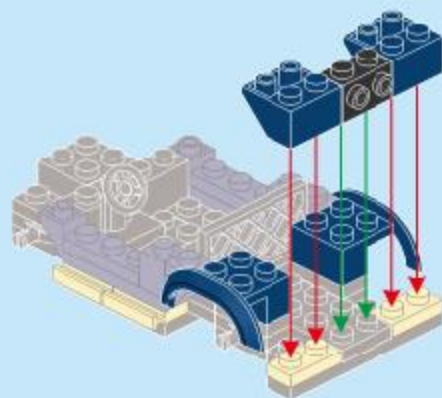

96

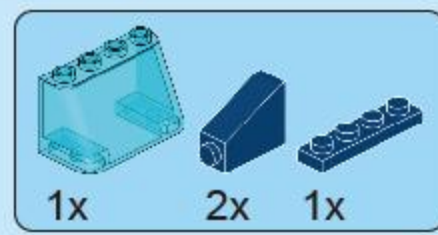
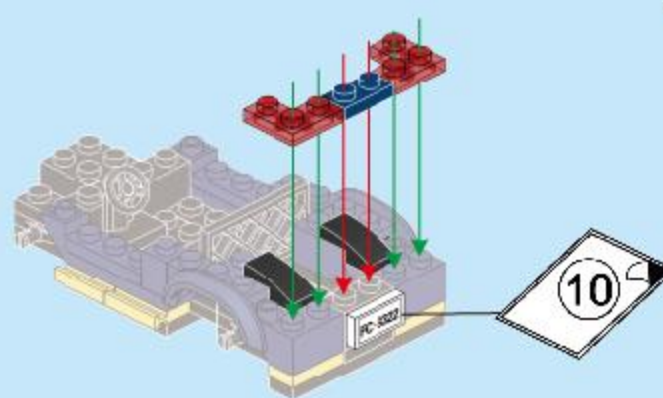

97

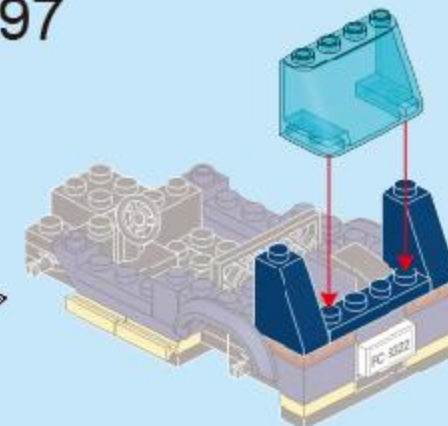



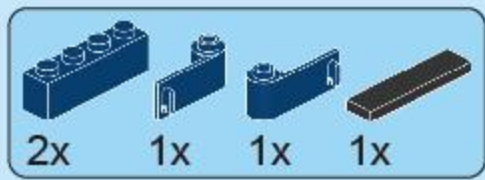

98

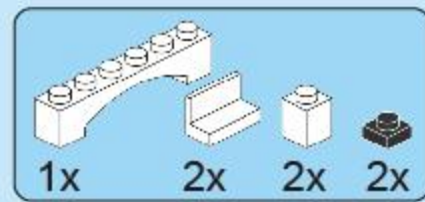
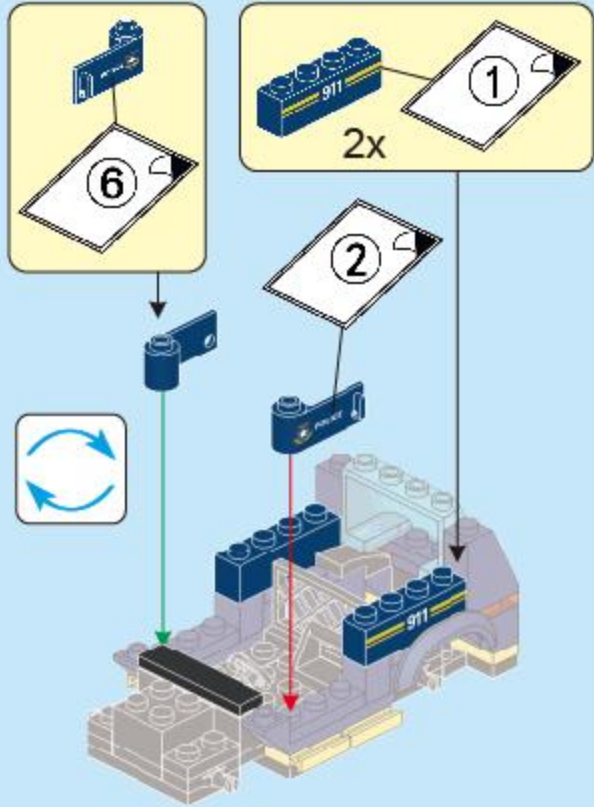

99

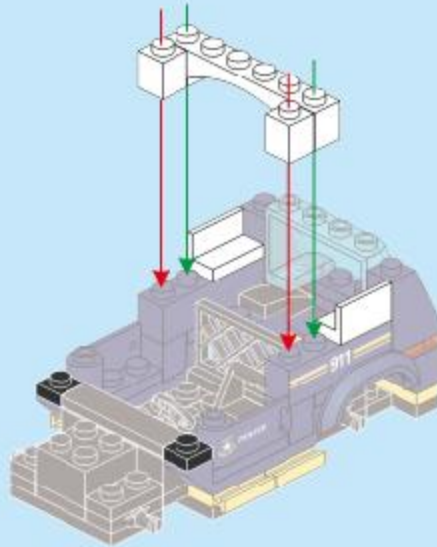

100

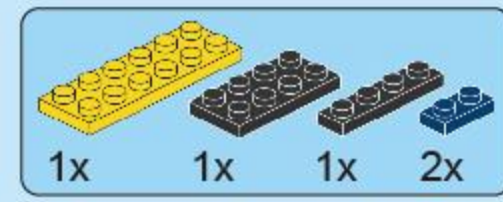
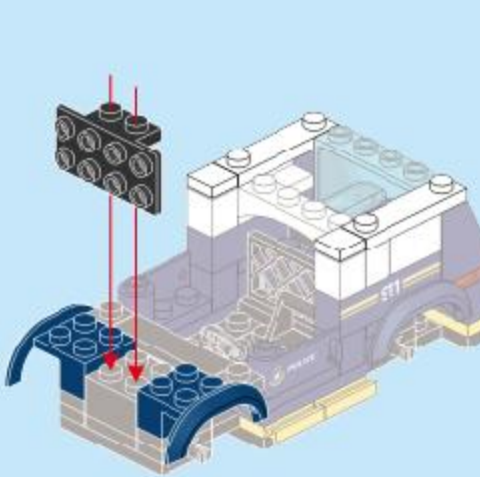

101

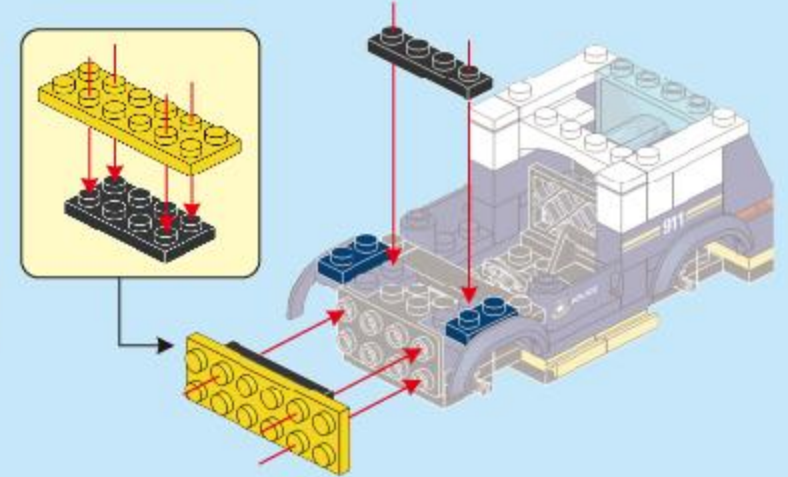

102

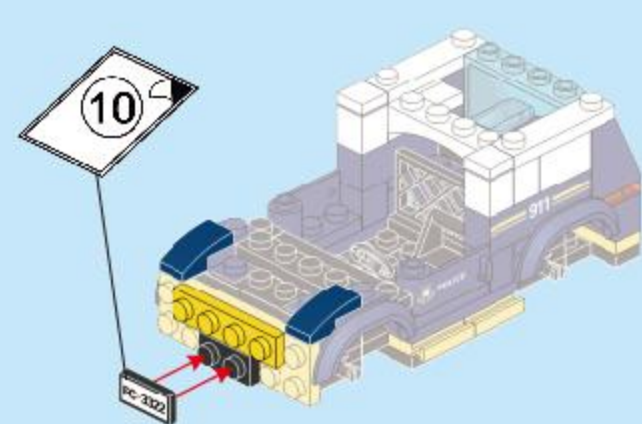

103

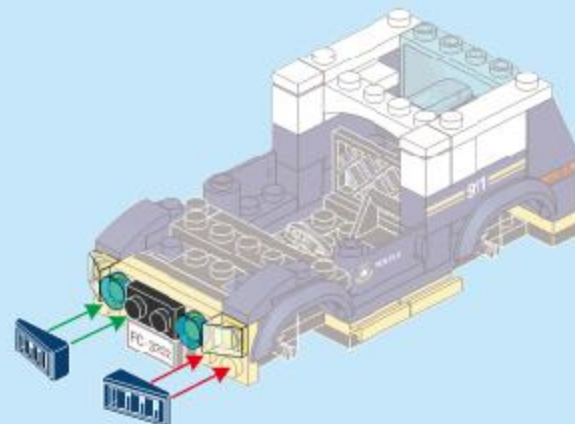

104

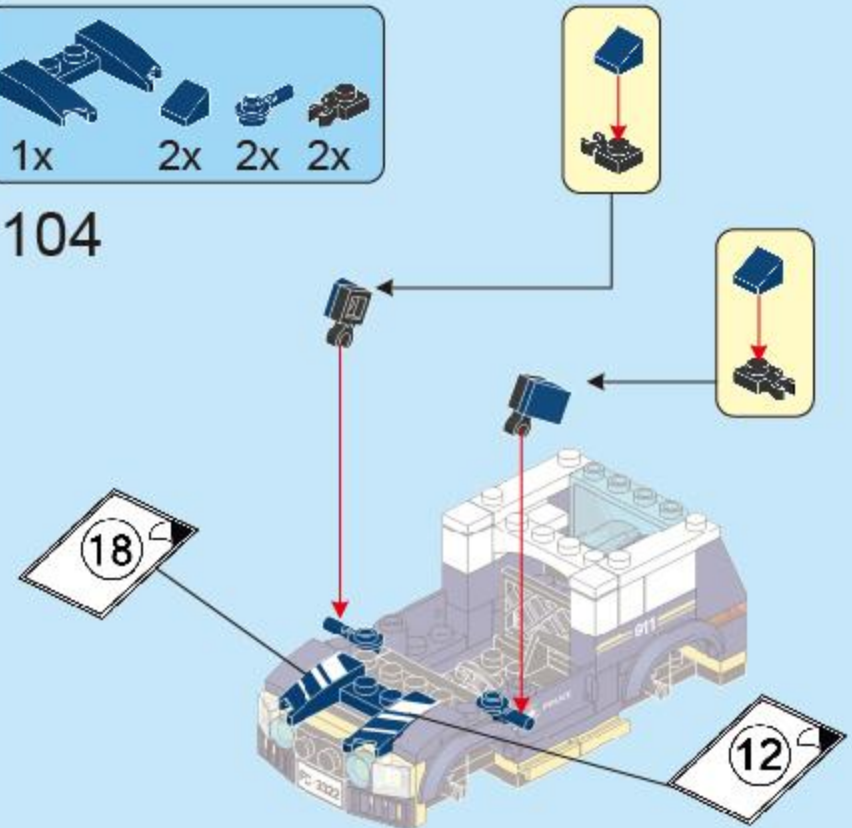

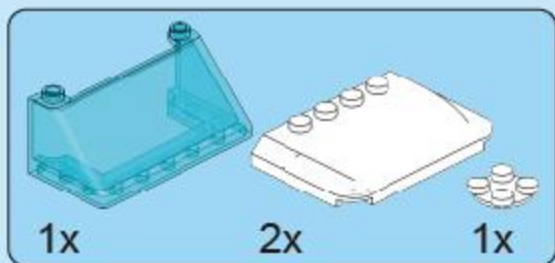

105

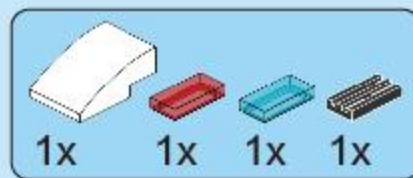
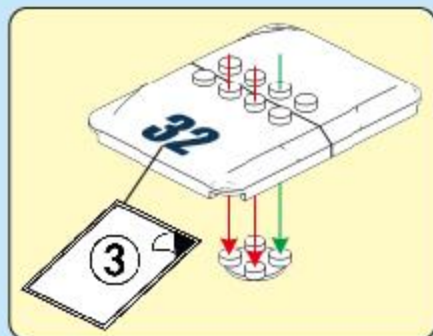

106

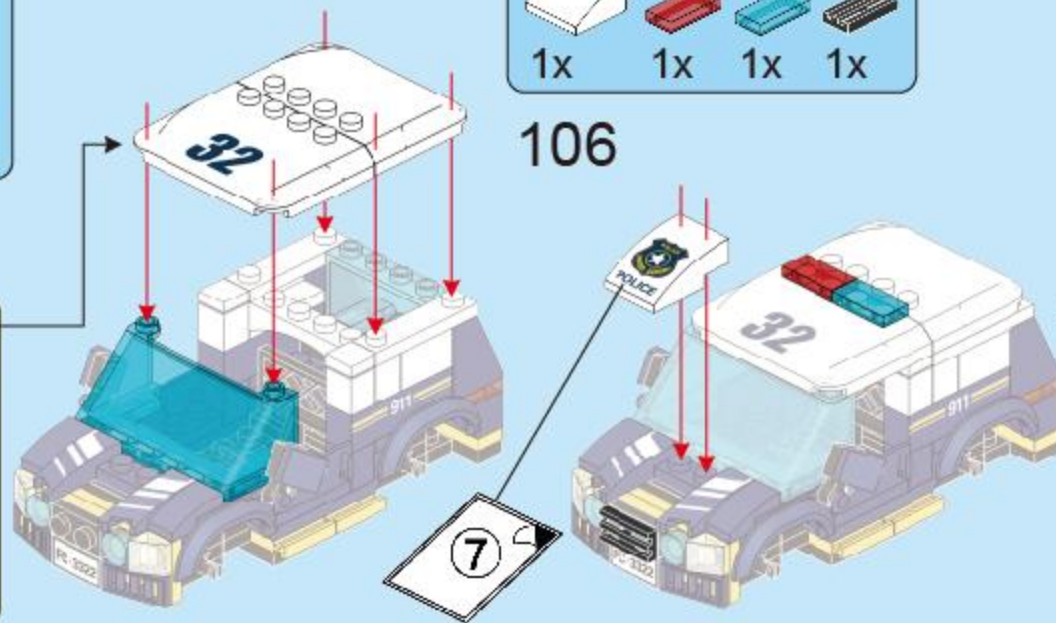

107

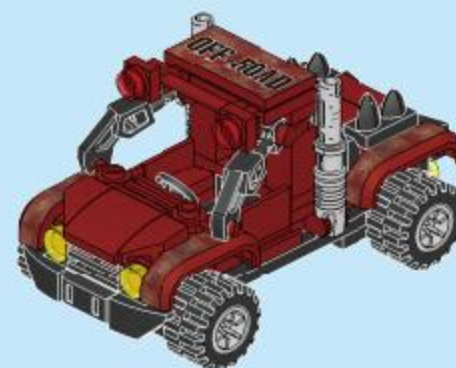
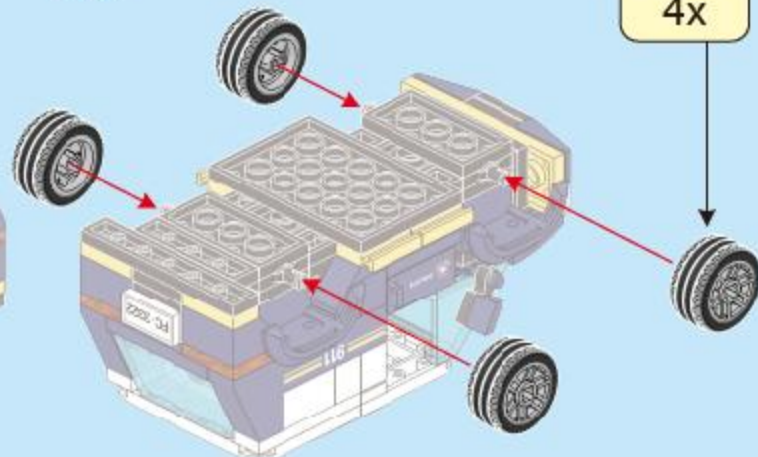

# CITY

Form 2



Form 3



# CITY

