

A1

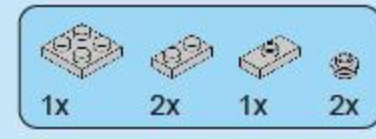

A2

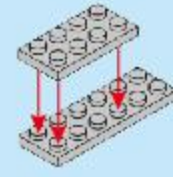
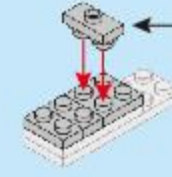

A3

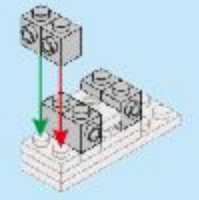

A4



A5



A6



A7



A8



A9

A10

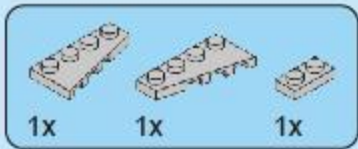
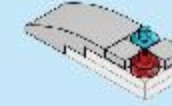
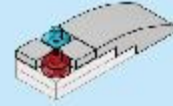
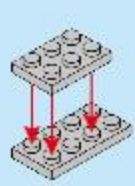
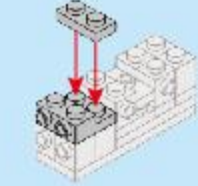
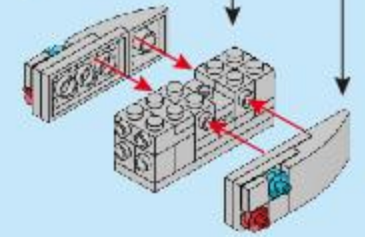

A11

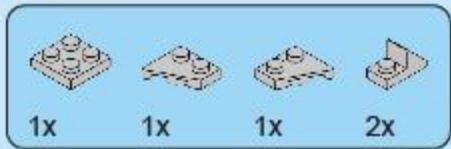

A12



A13

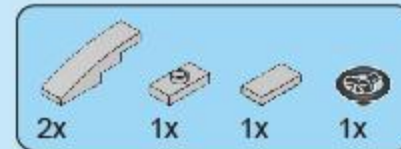

A14



A15

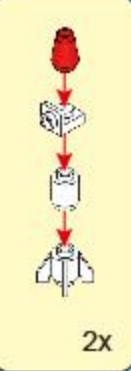
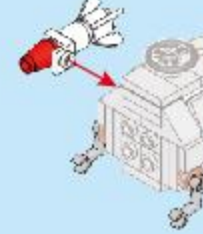
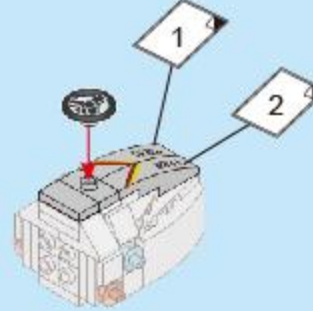
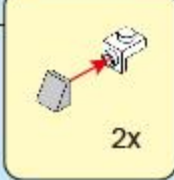
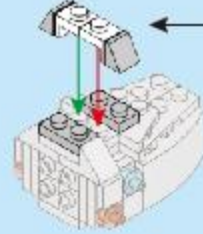
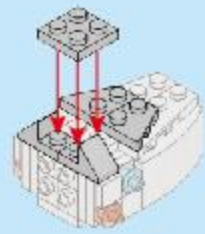
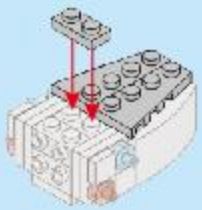

A16



A17

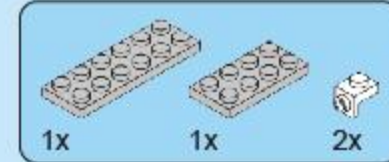

B1

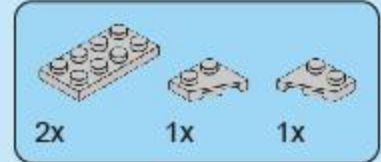

B2

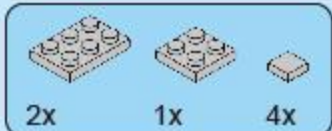
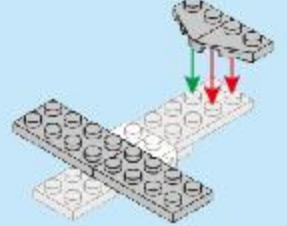
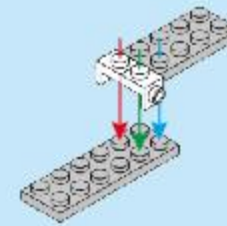
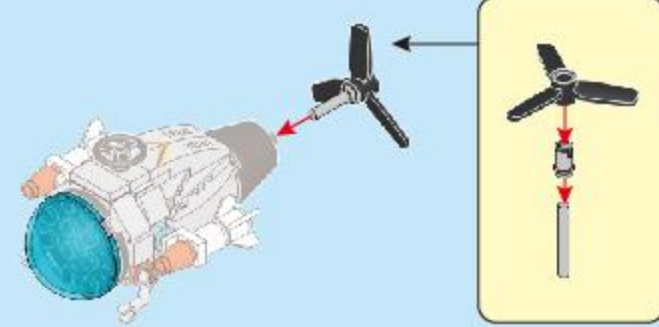
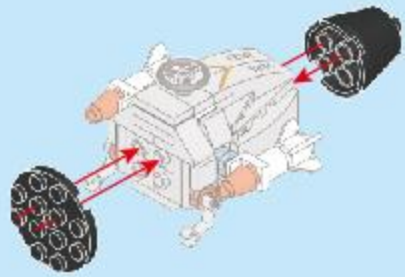

B3

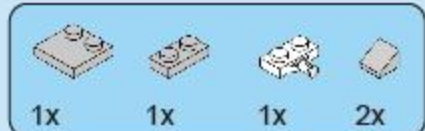

B4

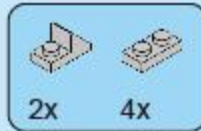

B5



B6

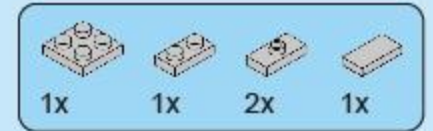

B7

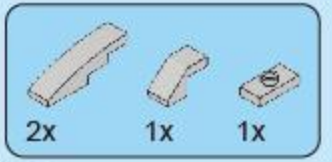
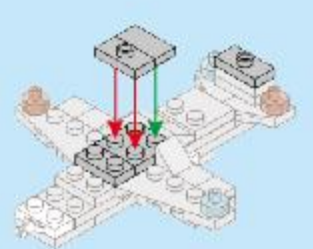
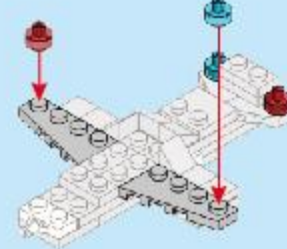
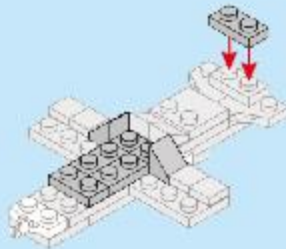
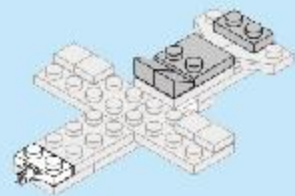
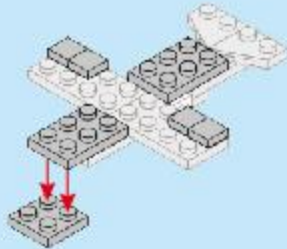

B8



B9



B10

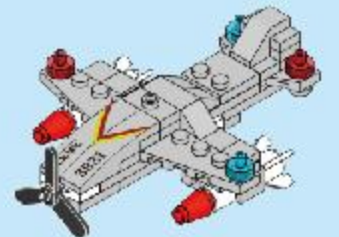
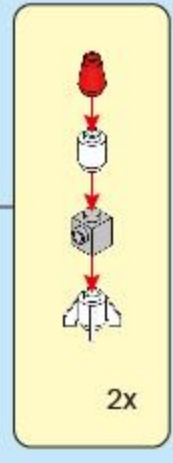
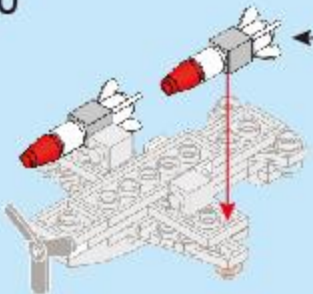
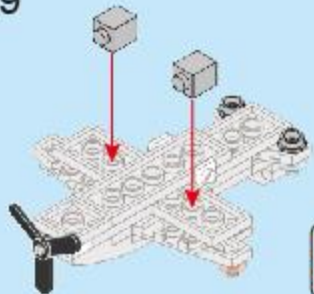
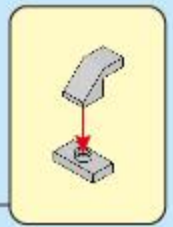



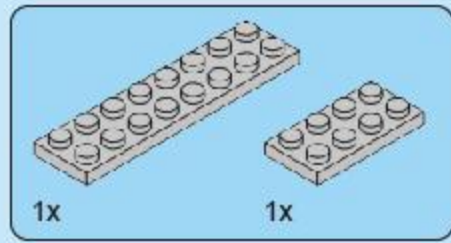

1

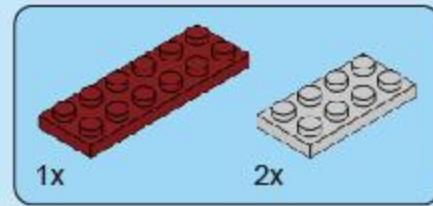
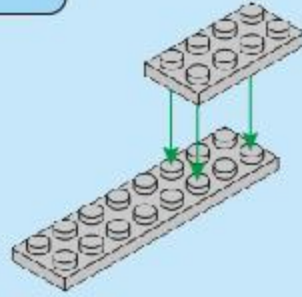

2

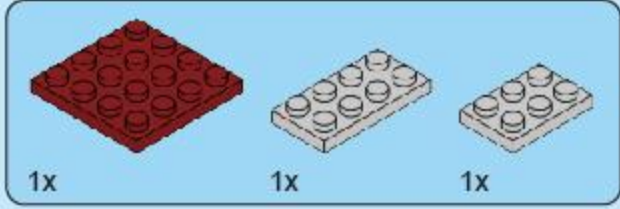
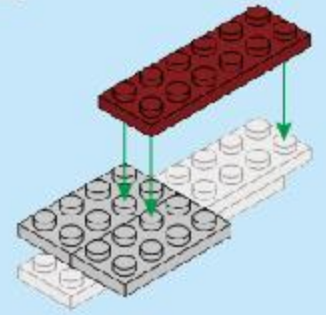

3

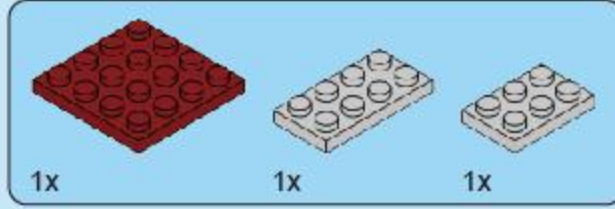

4

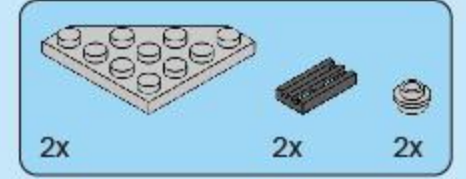

5

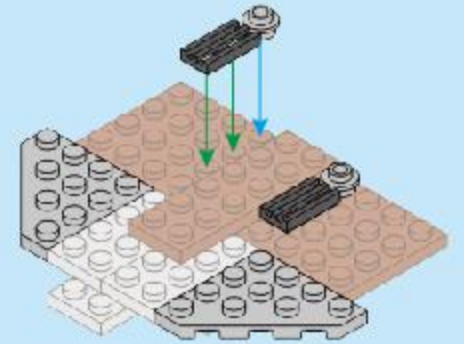
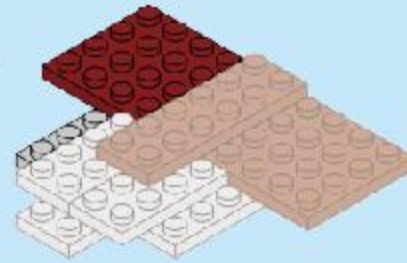
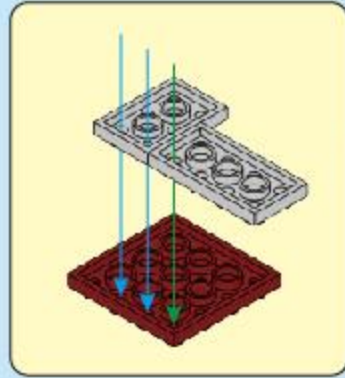
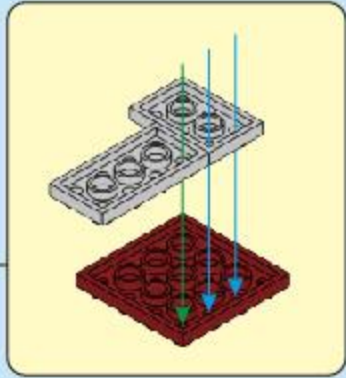
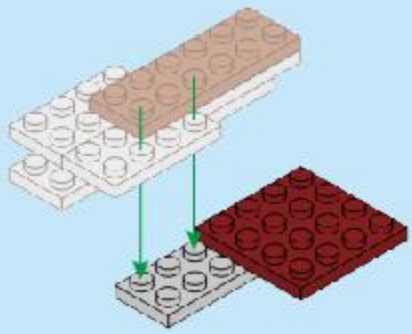

6

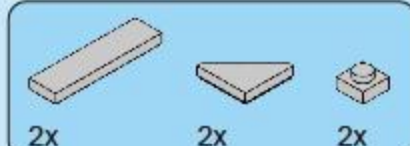

7

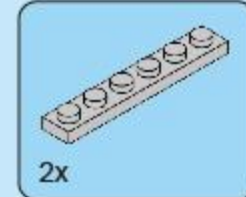

8

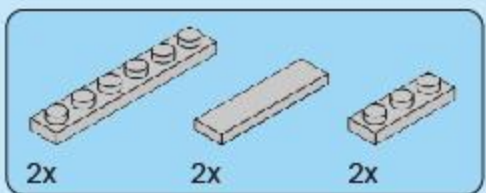
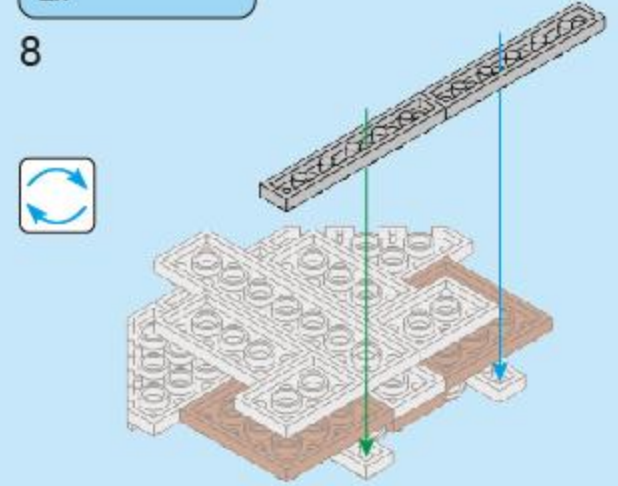
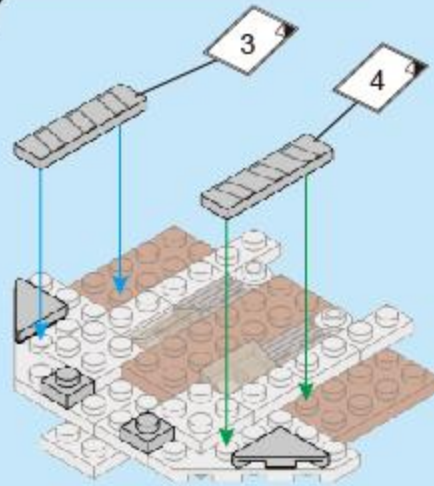
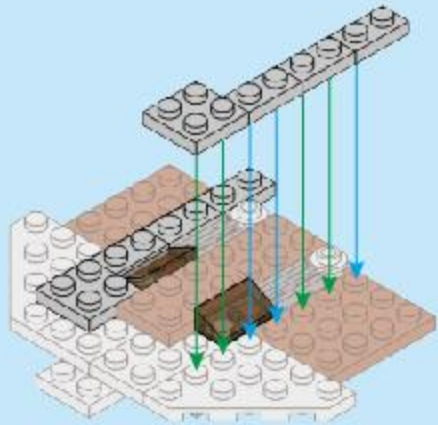

9

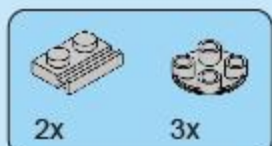

10

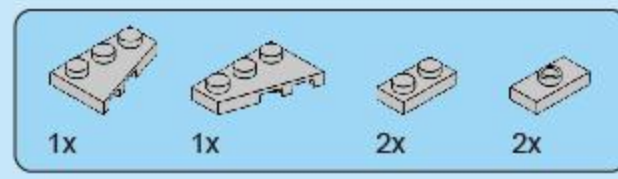

11

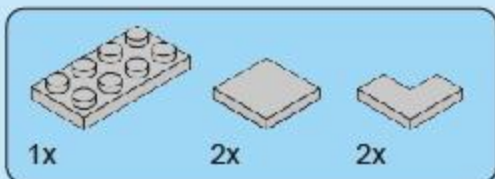
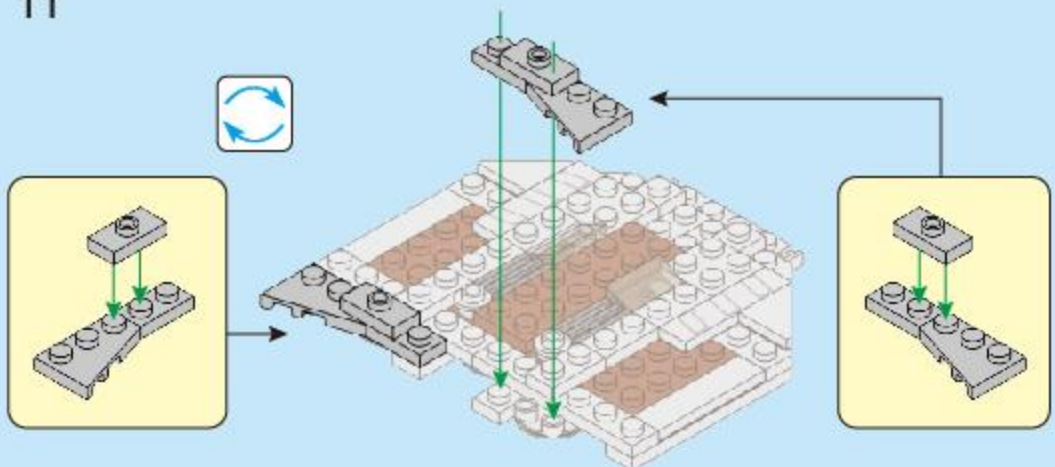
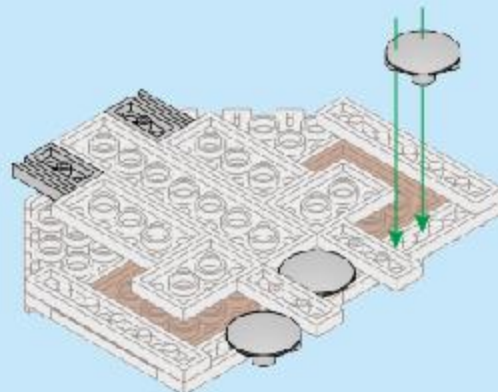
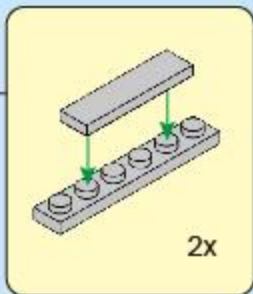
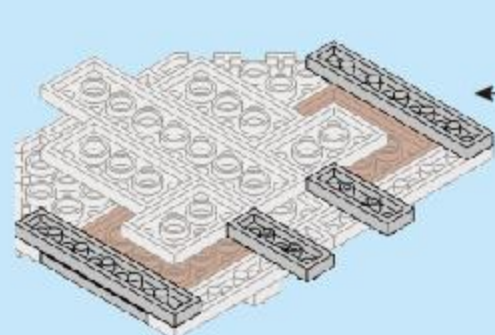

12

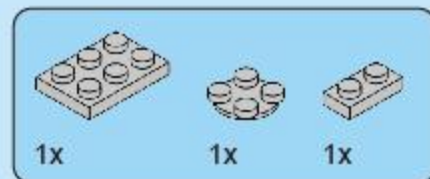
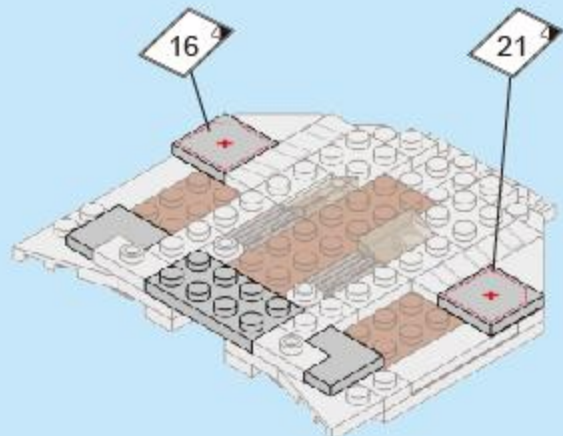

13

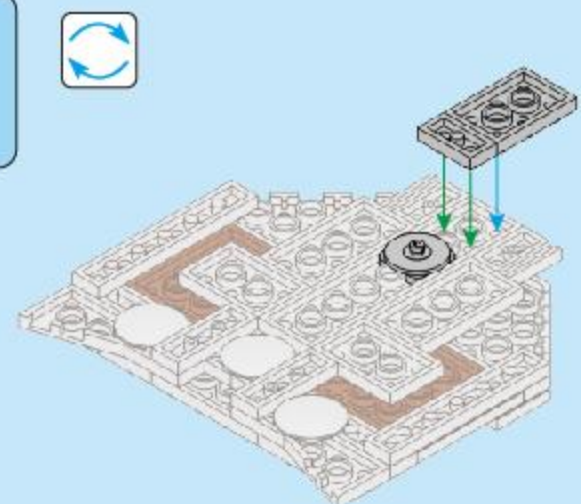



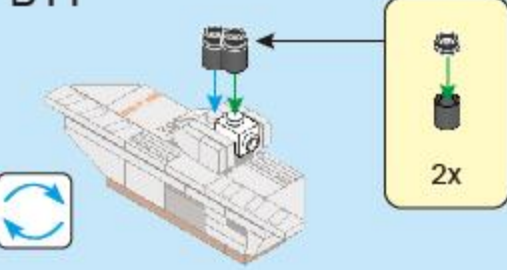
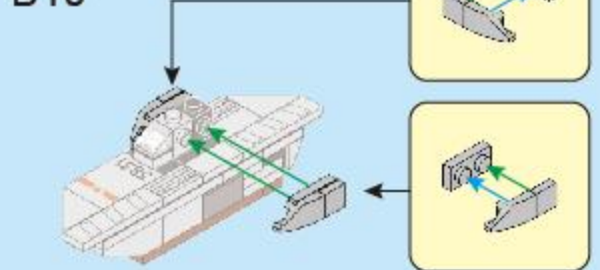
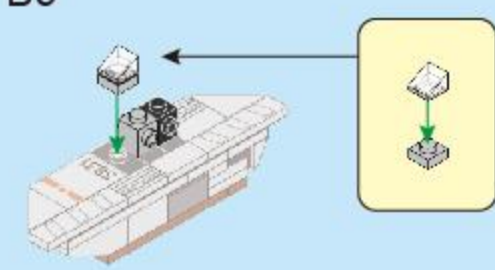
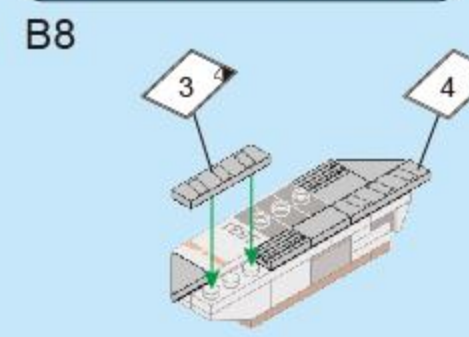
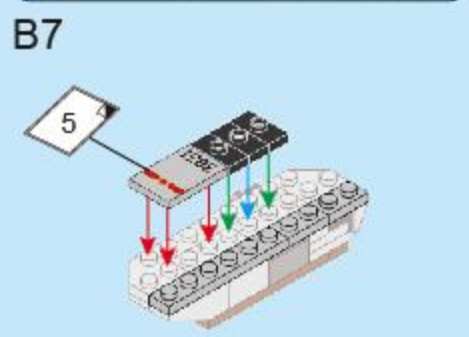
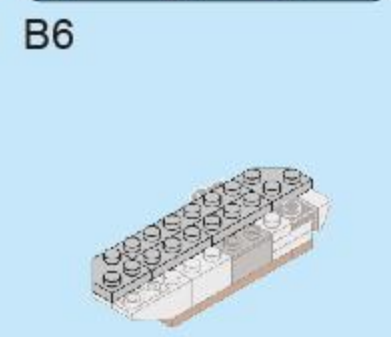
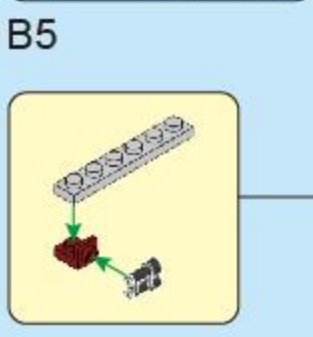
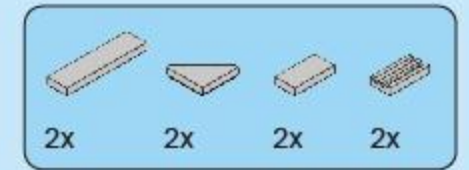
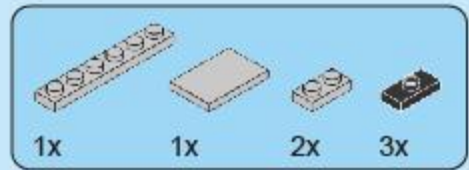
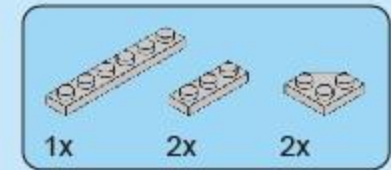
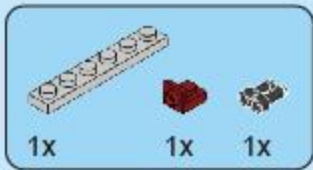
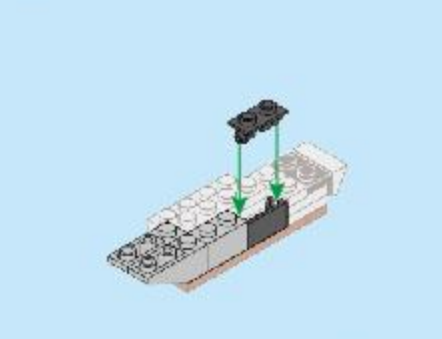
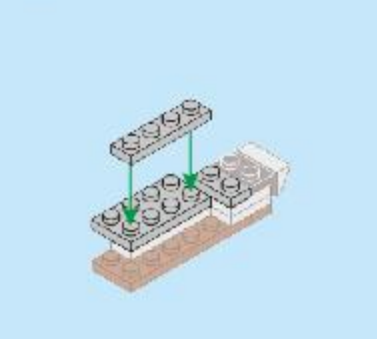
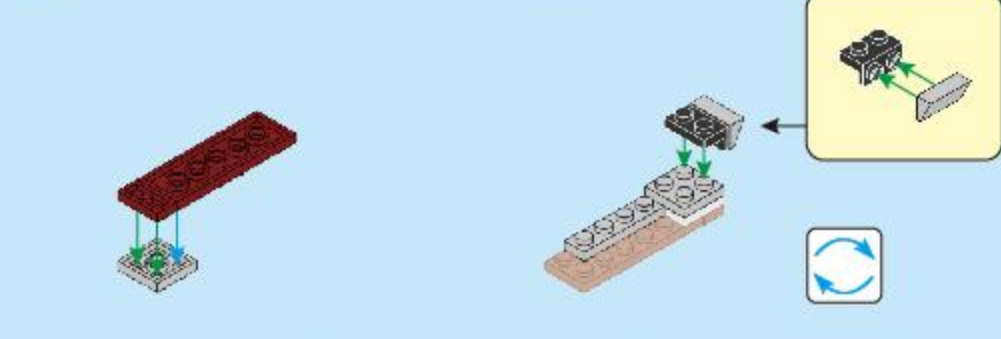
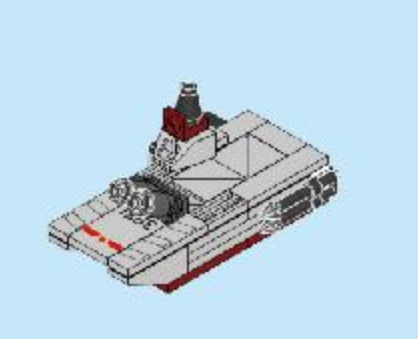
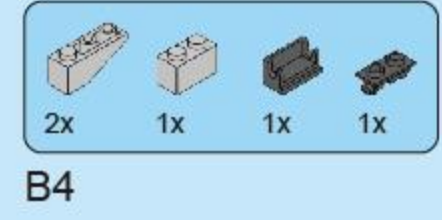
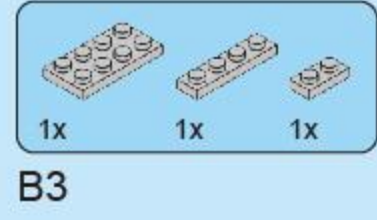
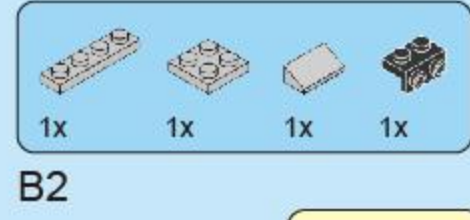
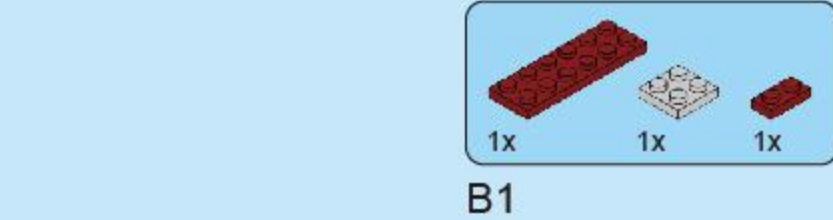
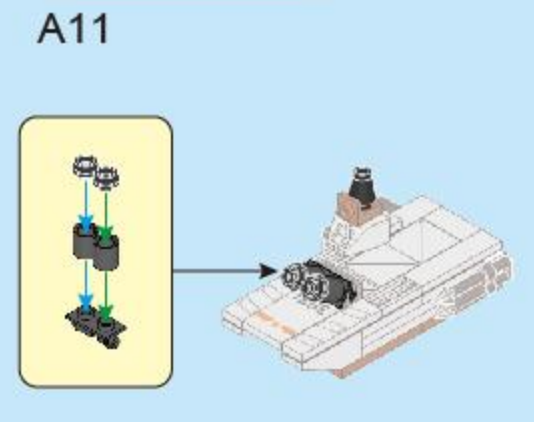
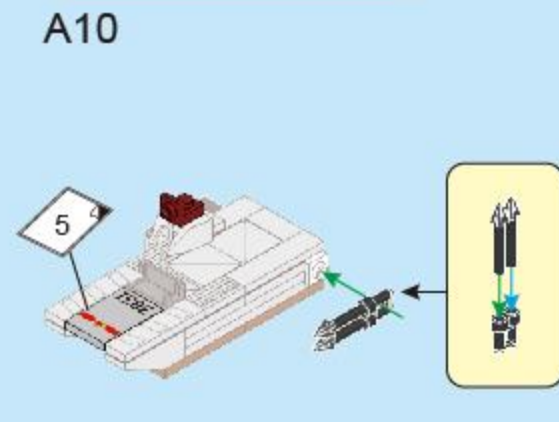
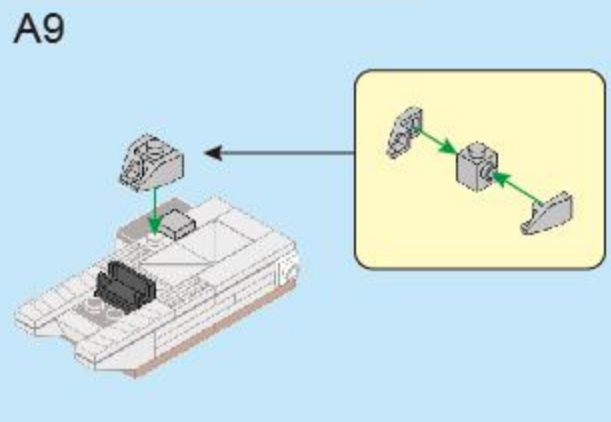
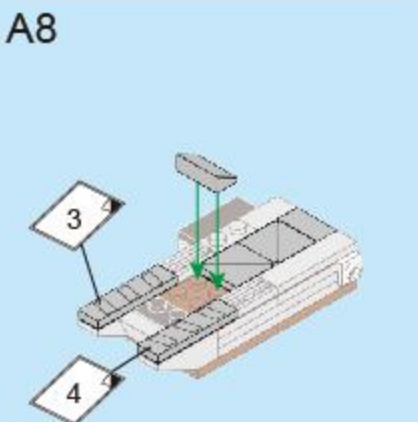
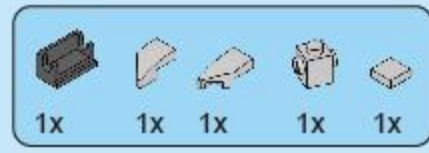
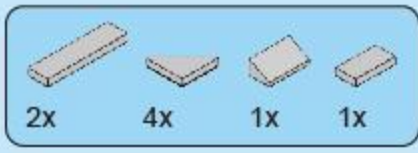
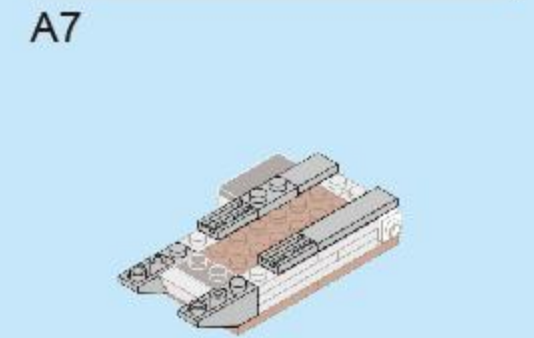
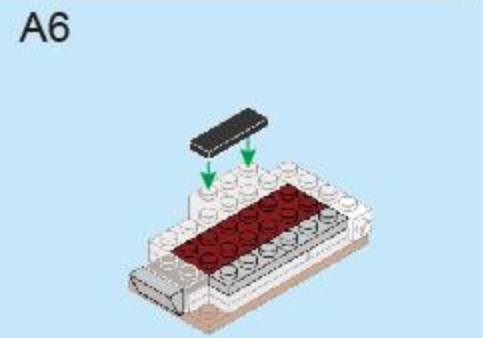
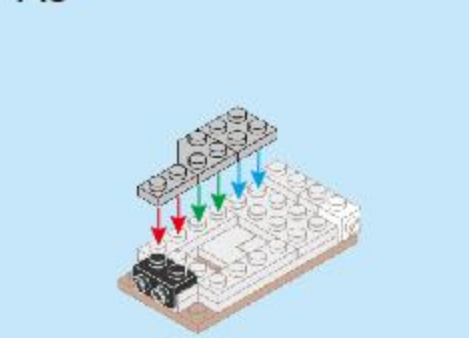
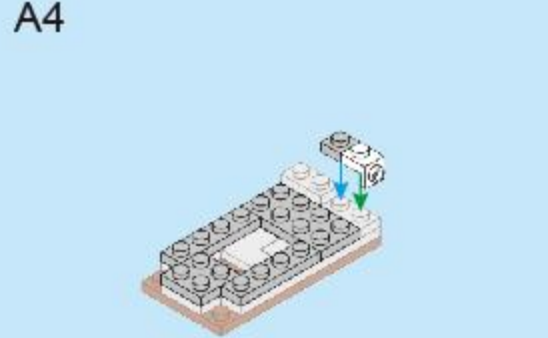
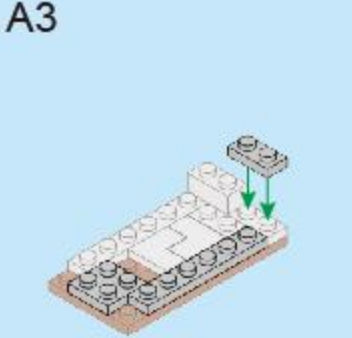
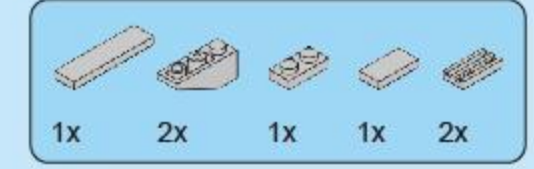
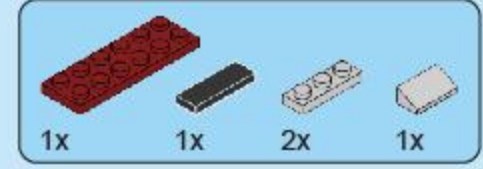
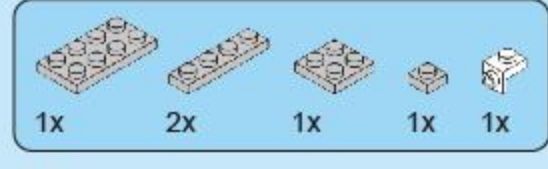
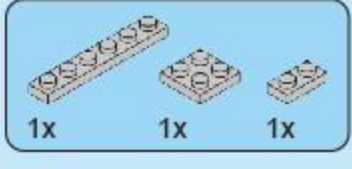
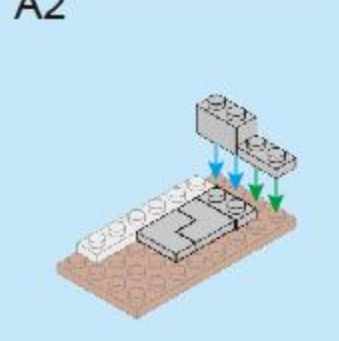
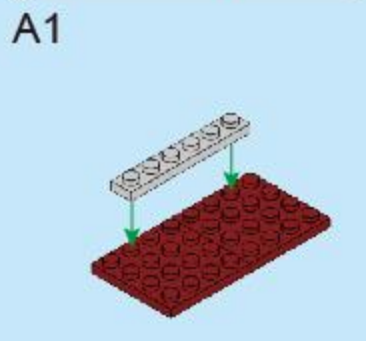
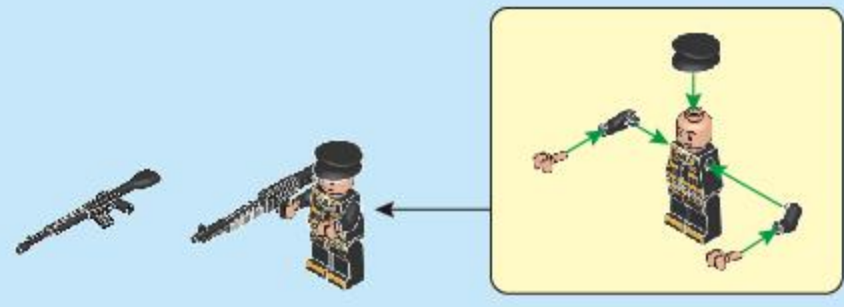
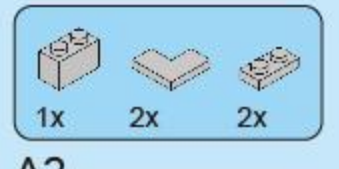
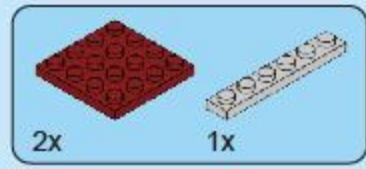



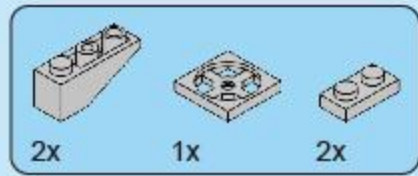

14

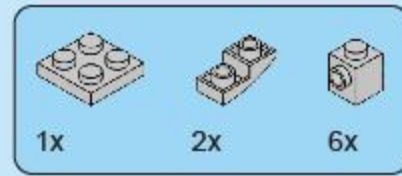
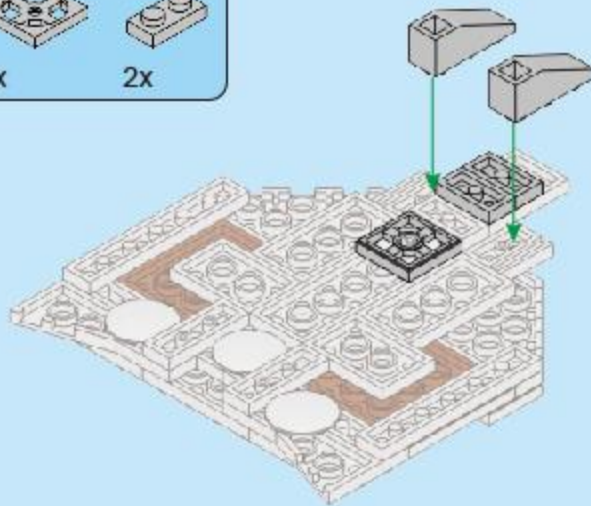

15

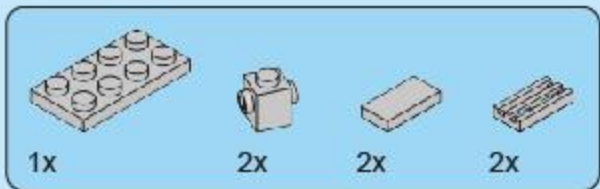
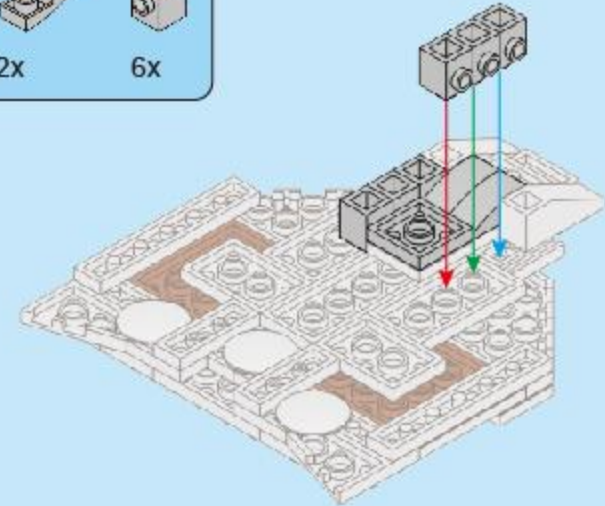

16

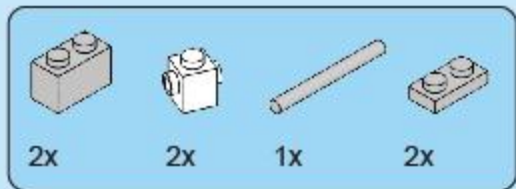
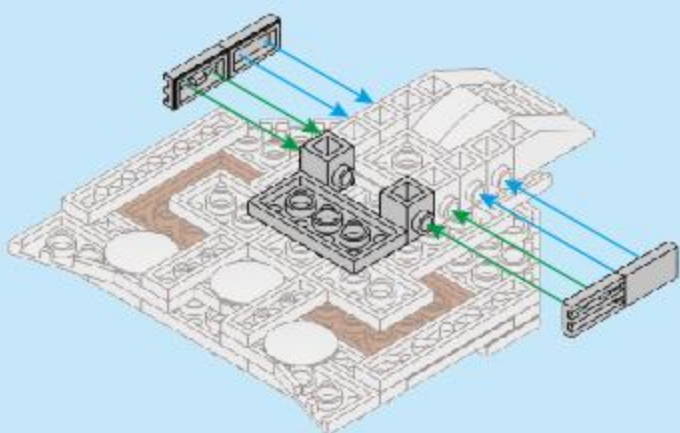

17

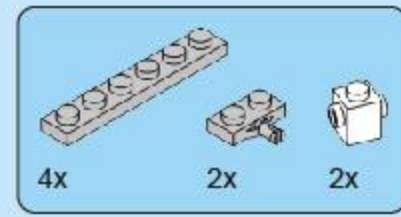
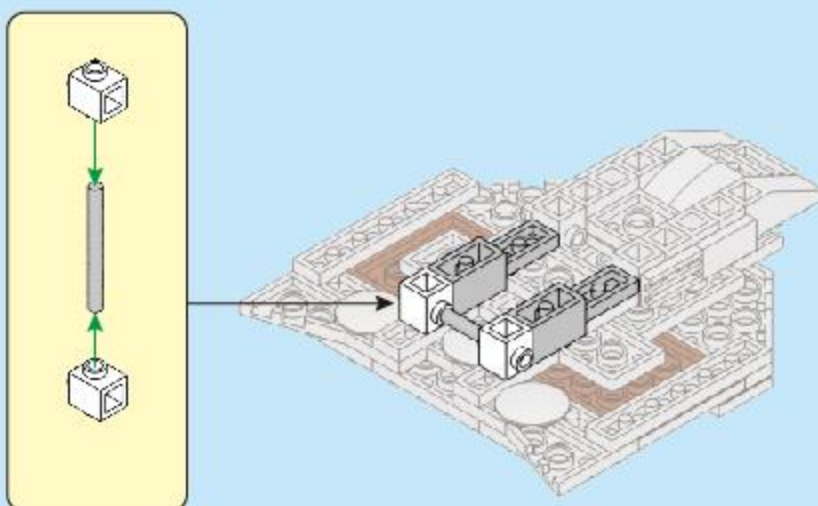

18

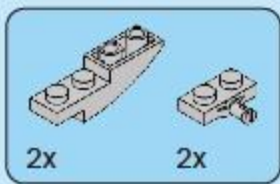
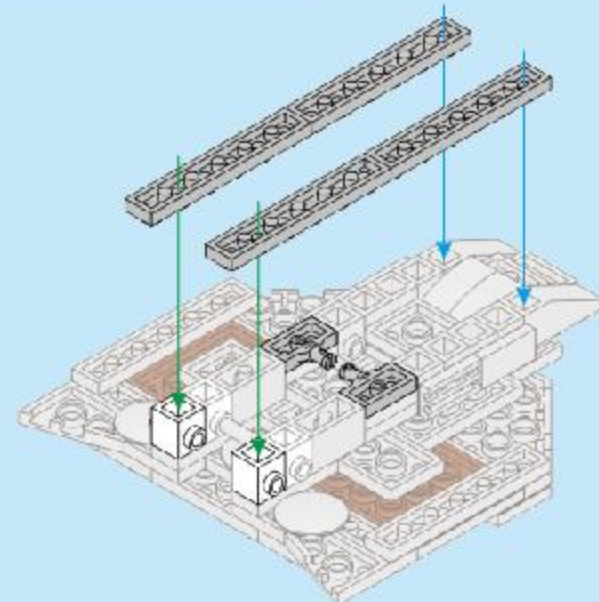

19

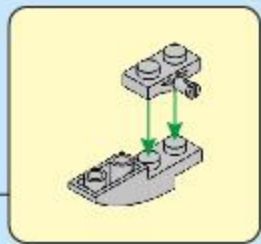
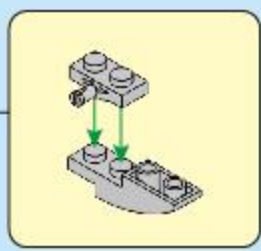
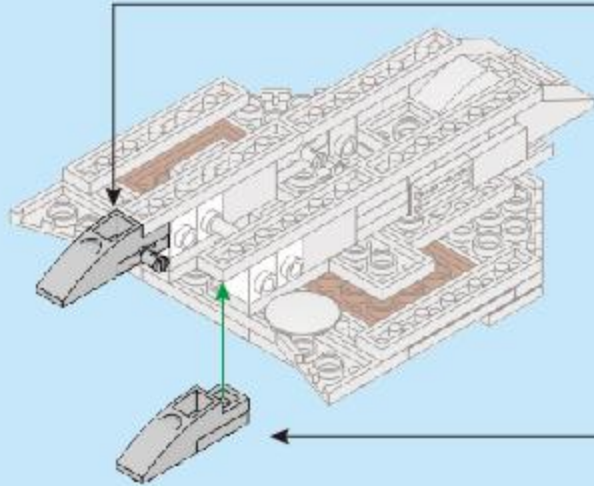

20

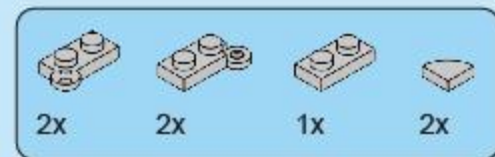
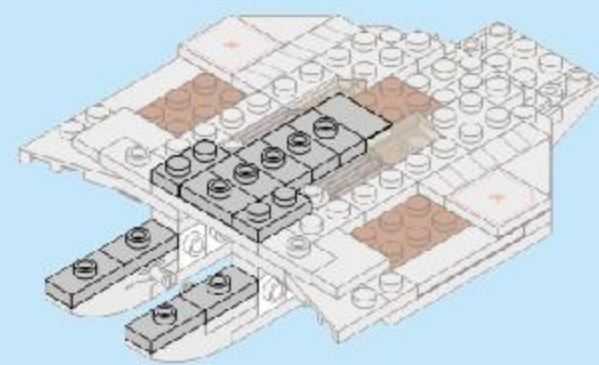

21

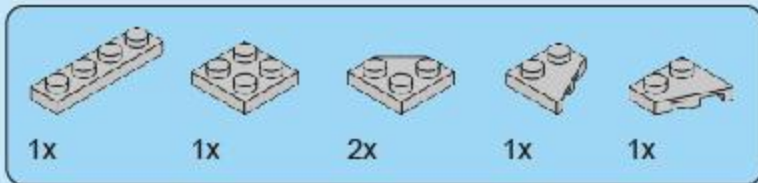
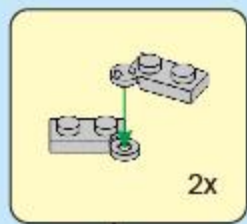
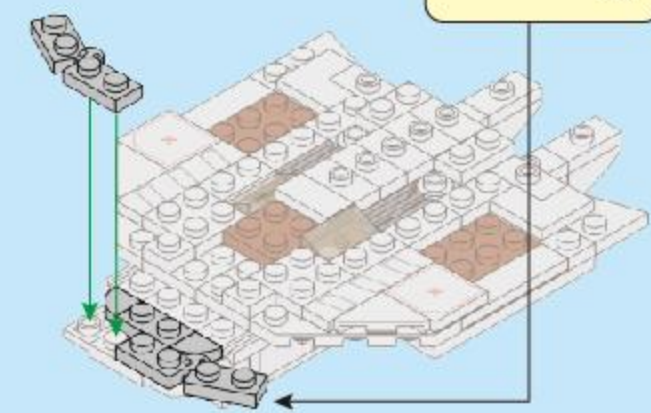

22

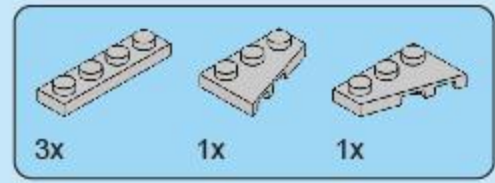
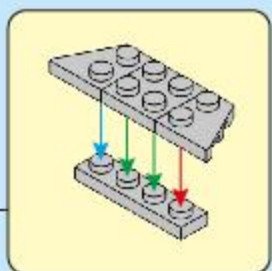
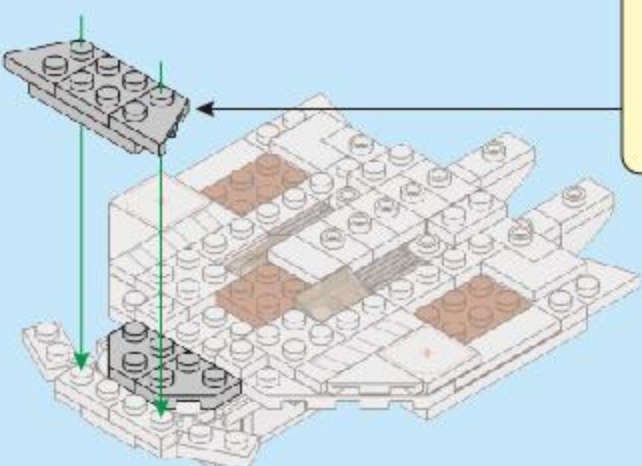

23

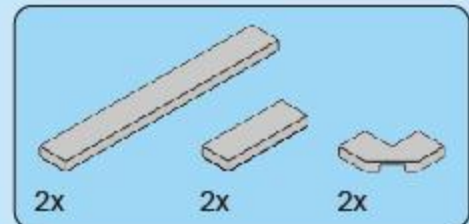
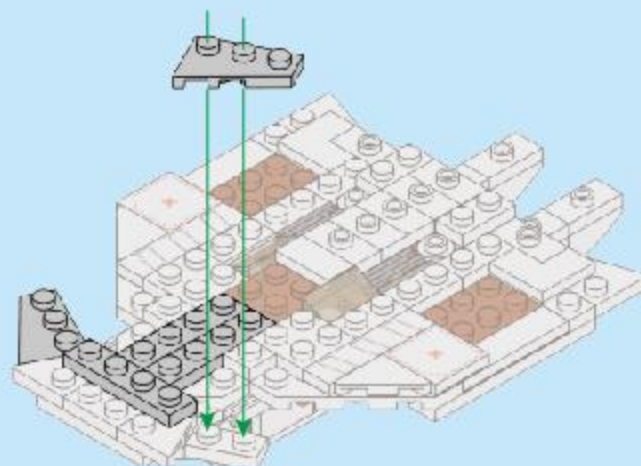

24

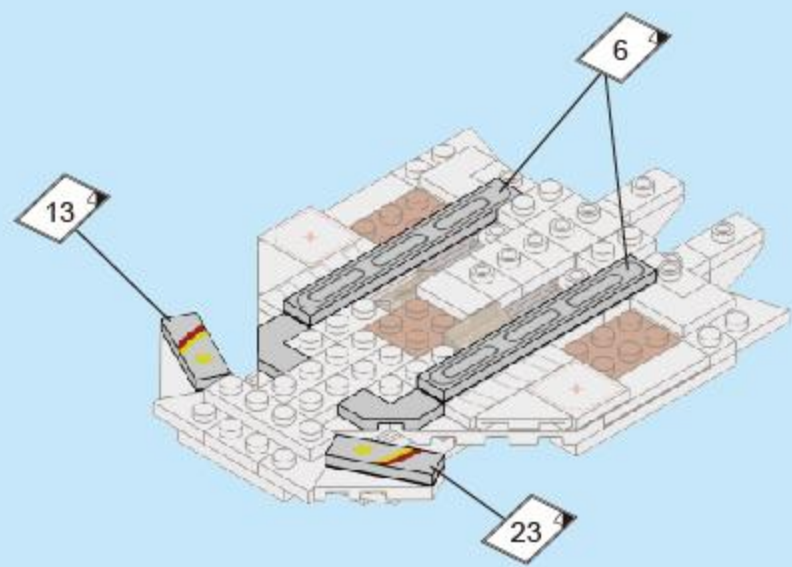



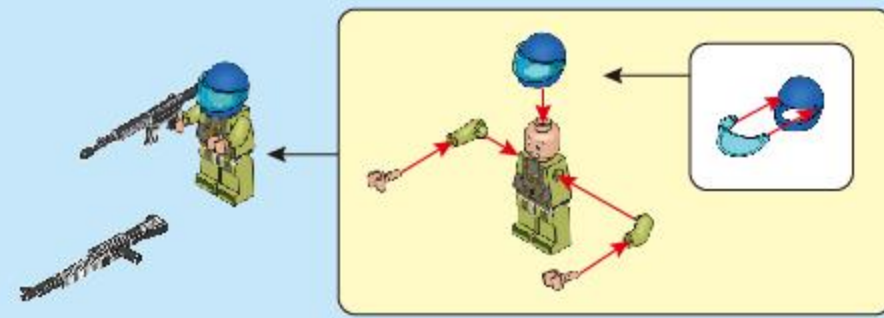
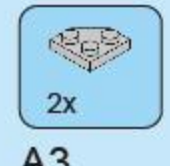
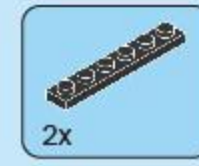
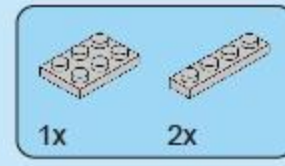

A1

A2

A3



A4

A5

A6

A7

A8

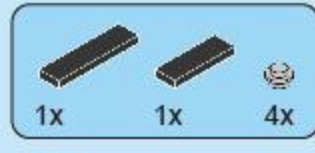
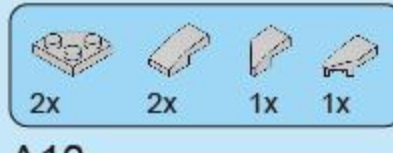
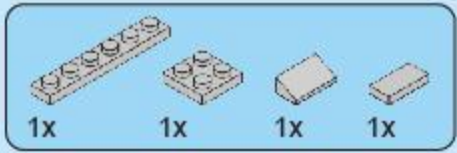
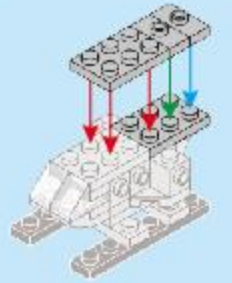
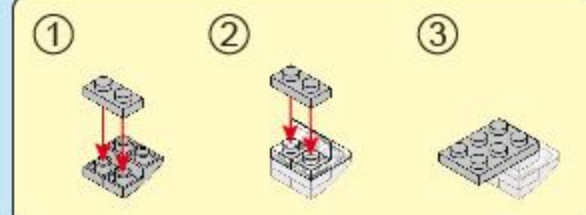
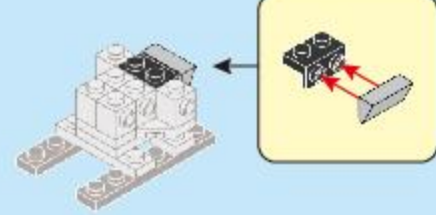
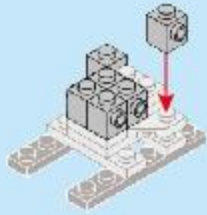

A9

A10

A11

A12

A13

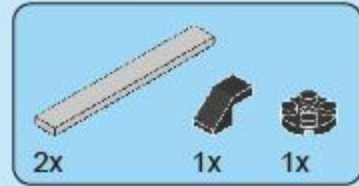
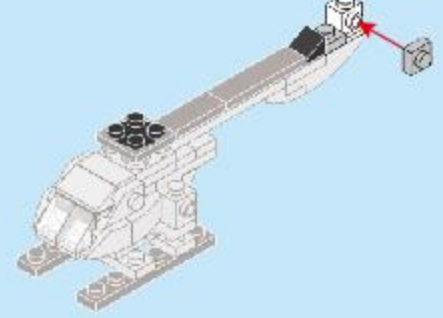
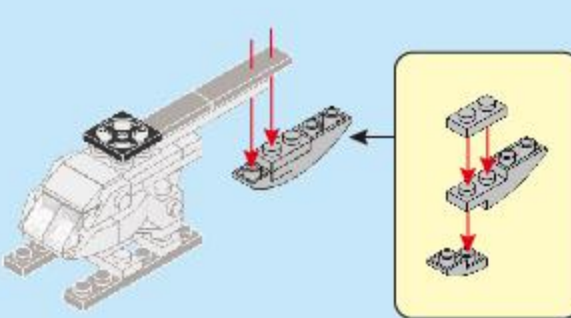
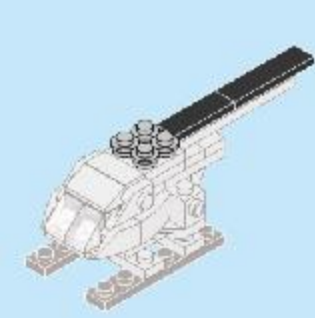
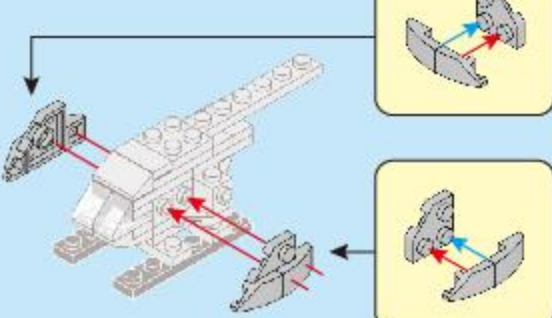
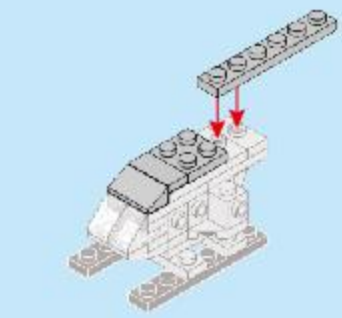

A14

A15

B1

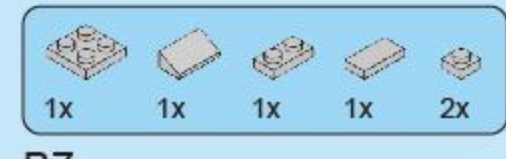
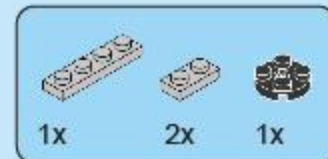
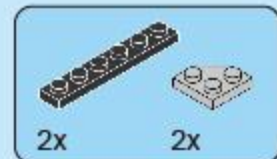
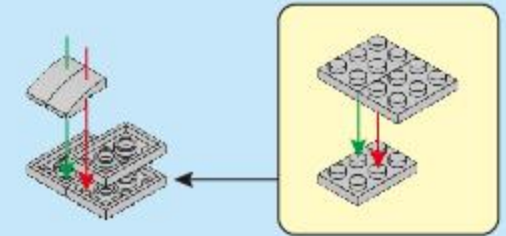
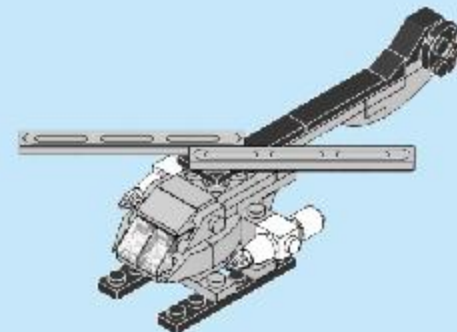
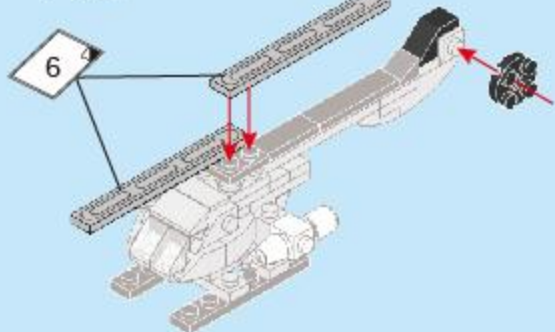
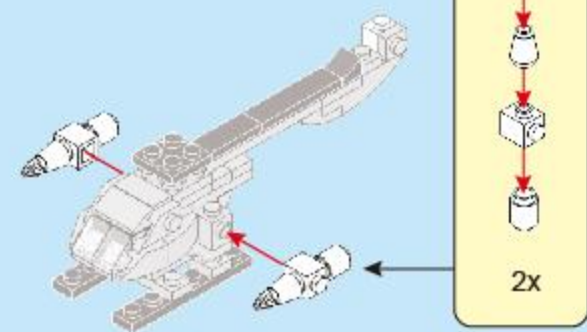

B2

B3

B4

B5

B6

B7

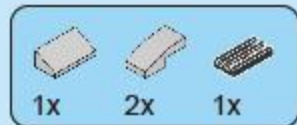
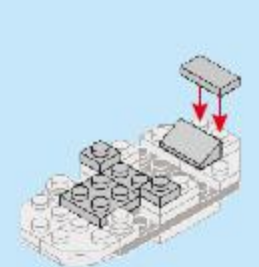
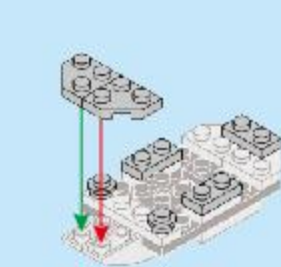
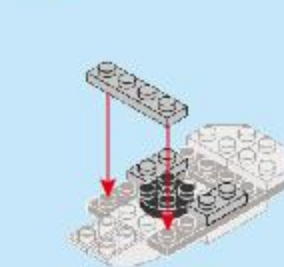
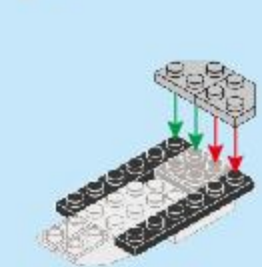
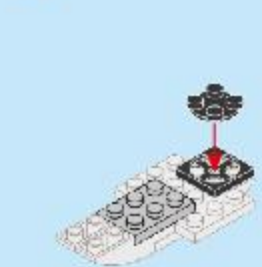
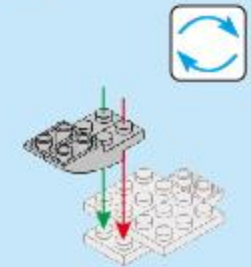

B8

B9

B10

B11

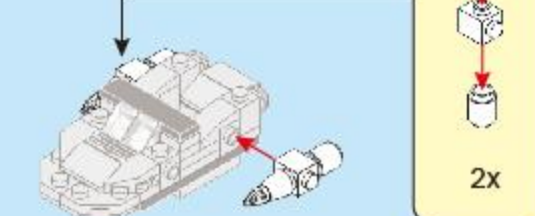
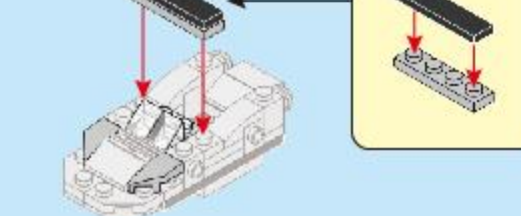
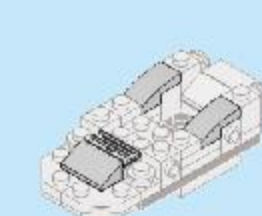
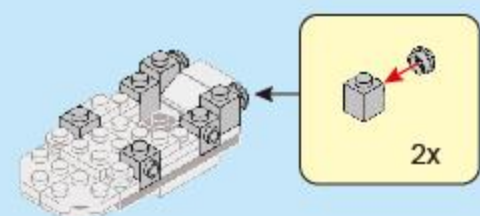



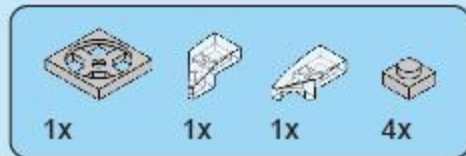

25

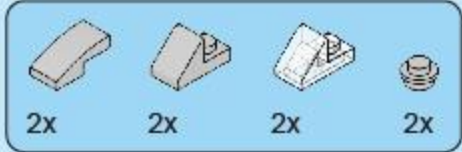
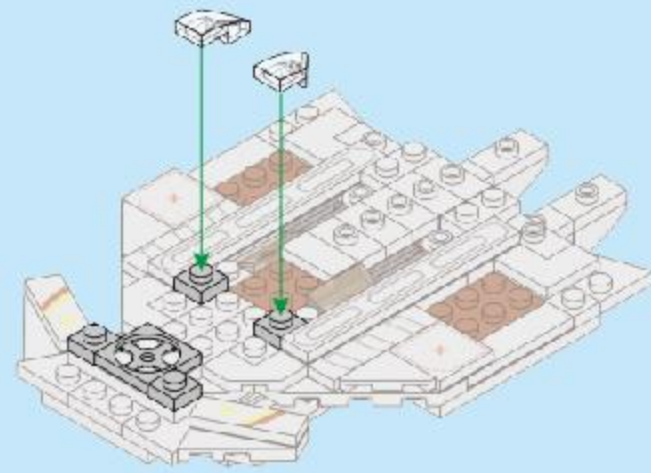

26

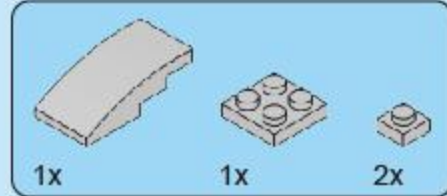
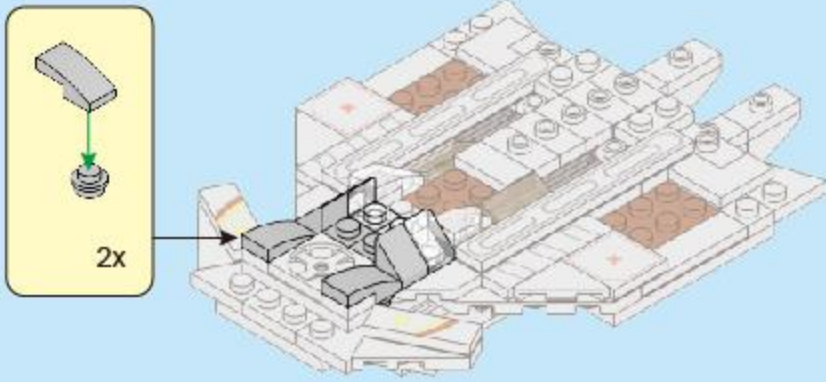

27

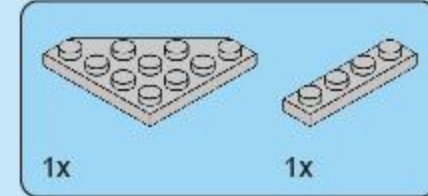
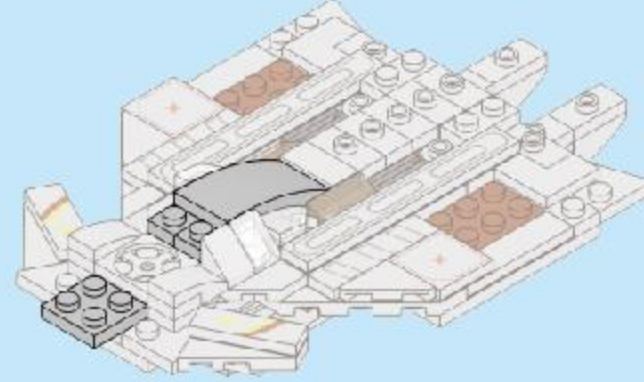

28

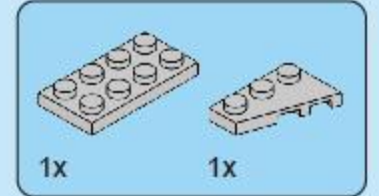
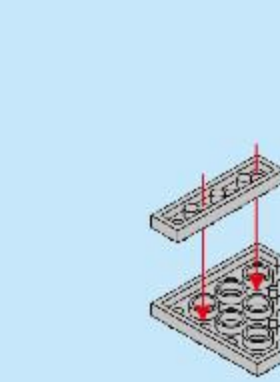

29

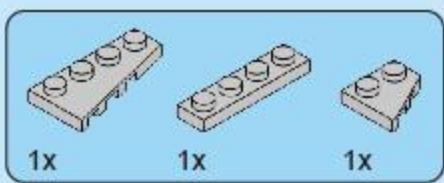
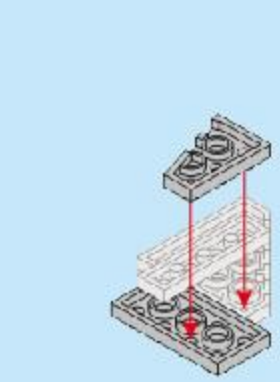

30

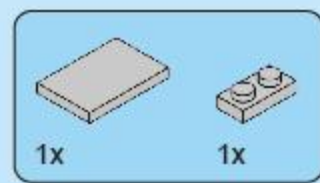
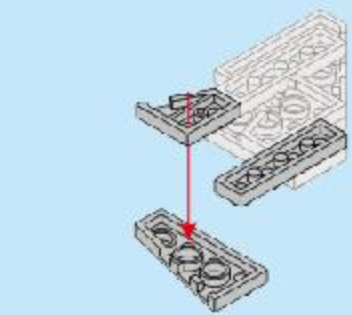

31

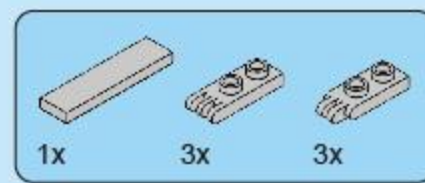
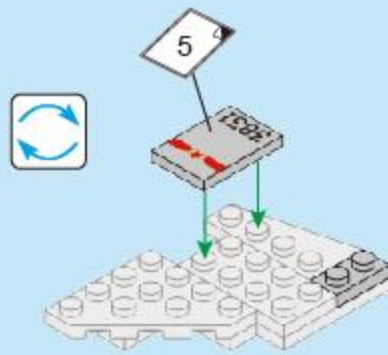

32

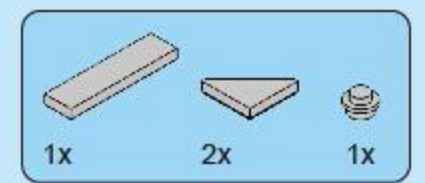
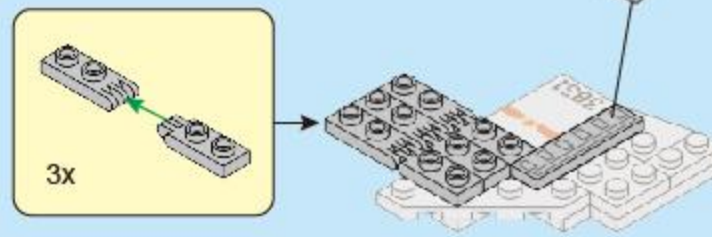

33

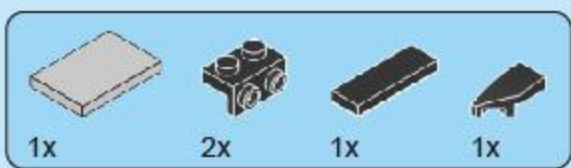
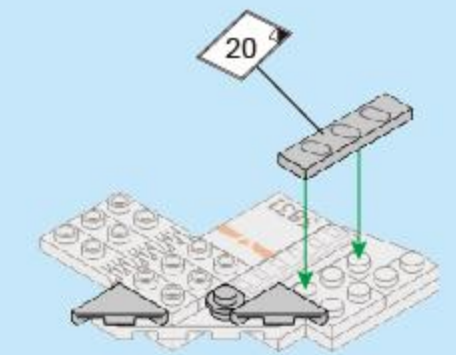

34

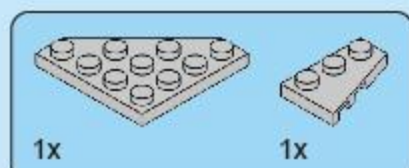
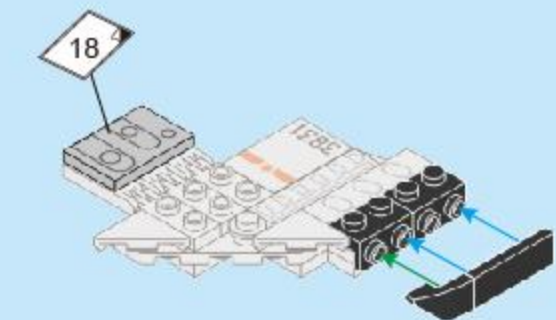

35

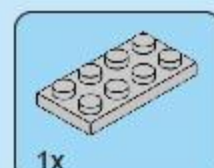
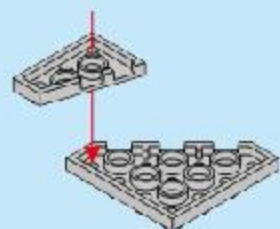

36

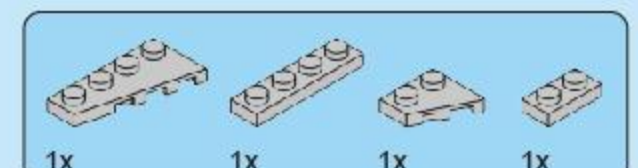
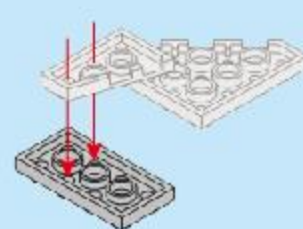

37

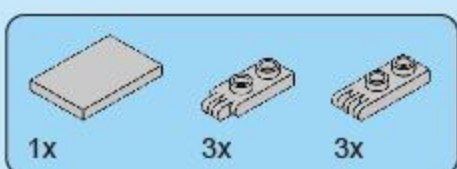
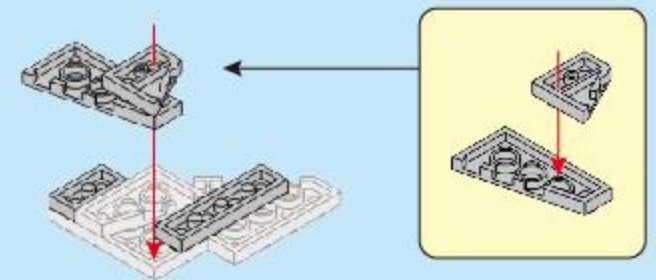

38

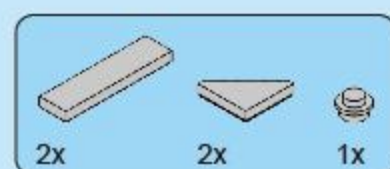
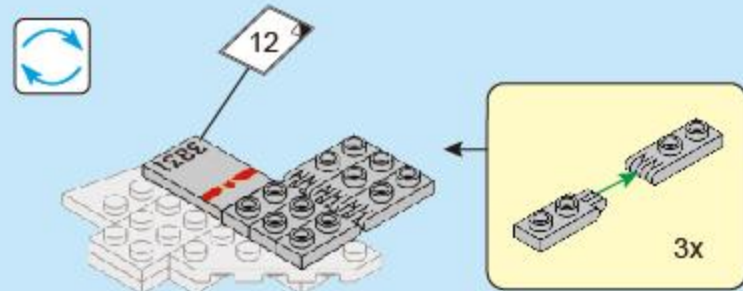

39

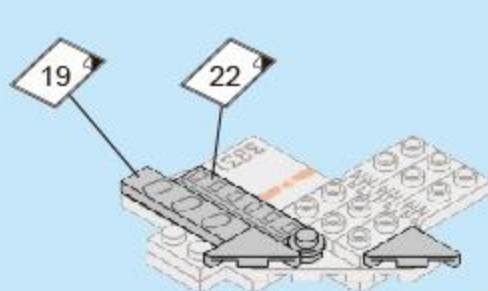

40

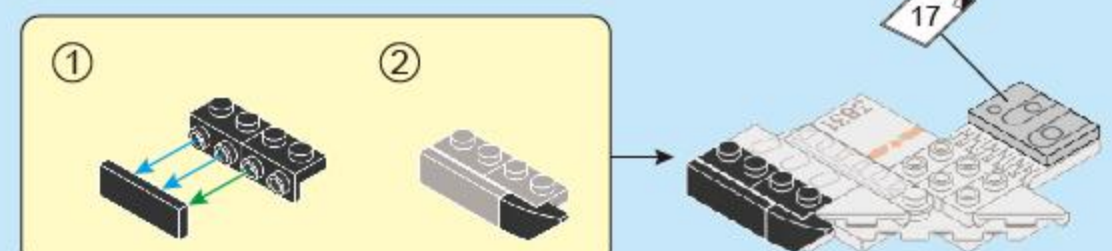





- 1x
- 1x
- 1x
- 1x
- 1x
- 2x

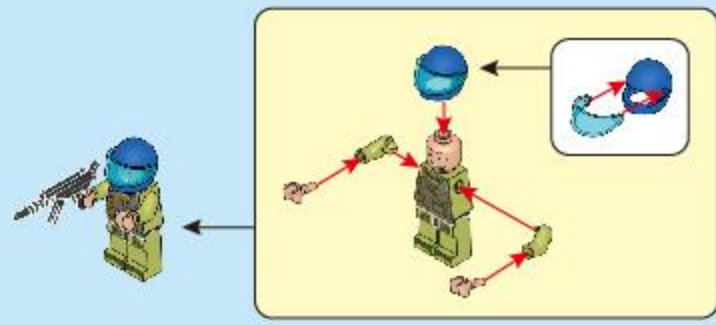

- 1x
- 2x

A1

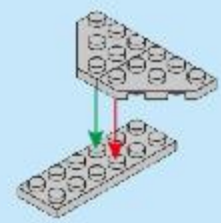

- 1x
- 2x

A2

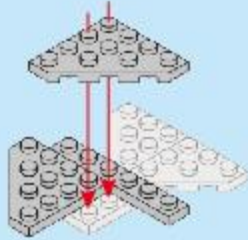

- 1x
- 2x
- 1x

A3

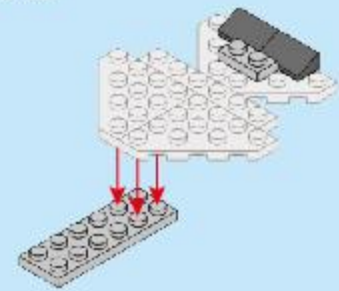

- 1x
- 1x
- 1x
- 1x

A4

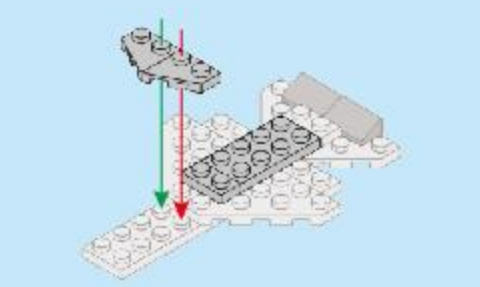

- 4x
- 1x
- 1x
- 2x

A5

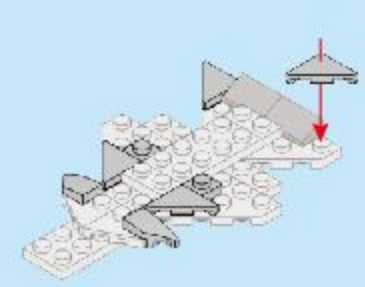

- 2x
- 2x
- 2x
- 2x

A6

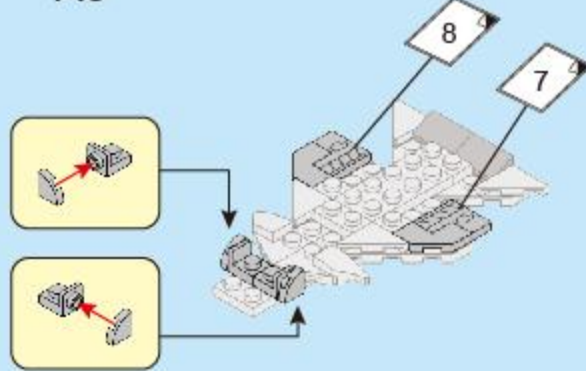

- 1x
- 1x
- 1x
- 5x

A7

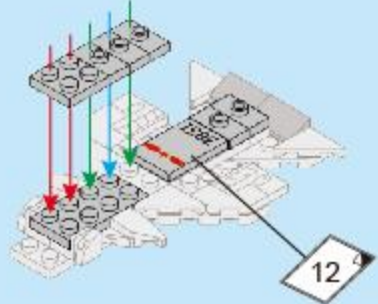

- 1x
- 1x
- 2x

A8

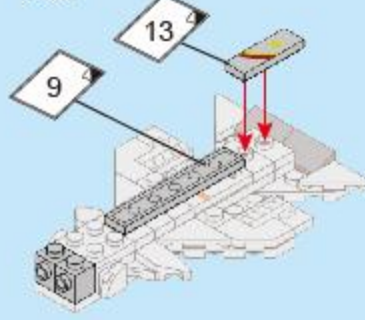

- 2x
- 1x
- 1x
- 1x
- 1x

A9

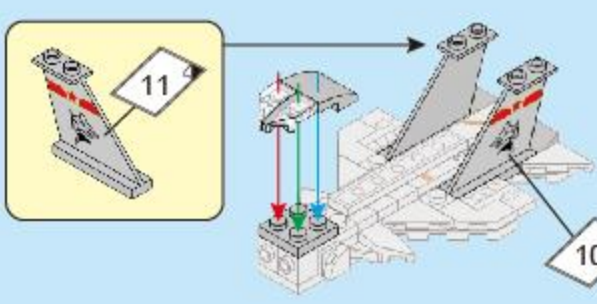

- 2x
- 2x

A10

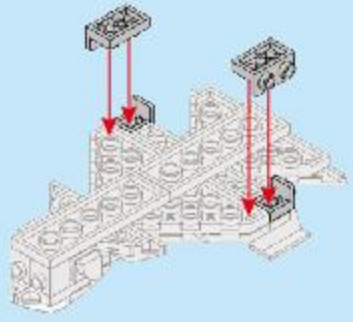

- 2x
- 1x

A11

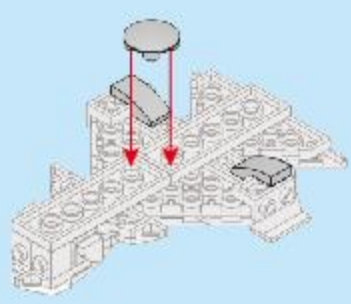

- 2x
- 2x
- 2x
- 2x
- 2x

A12

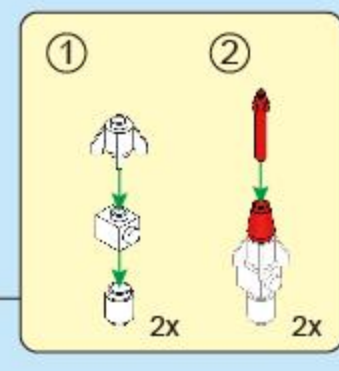

- 1x
- 3x
- 1x

A13

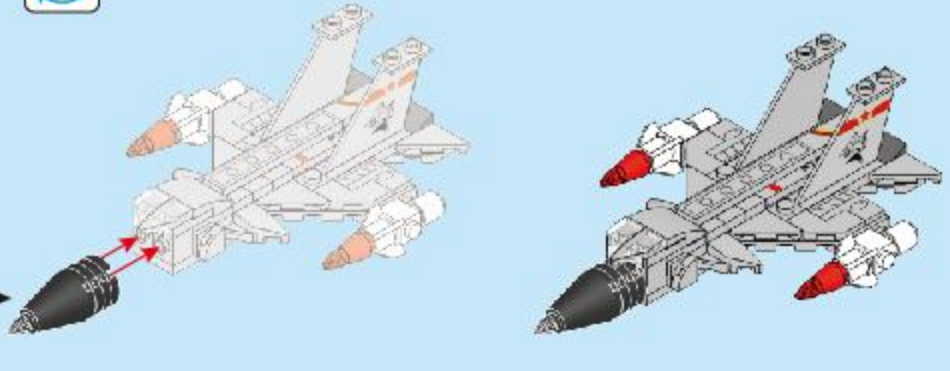
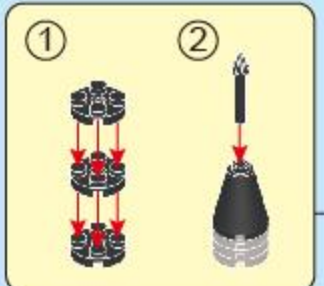

- 1x
- 1x

B1

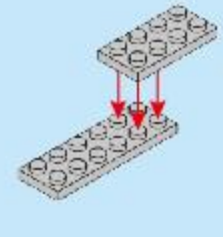

- 2x
- 2x

B2

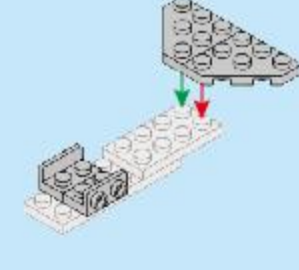

- 2x
- 2x
- 2x

B3

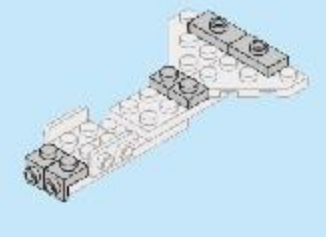

- 1x
- 2x
- 1x
- 2x

B4

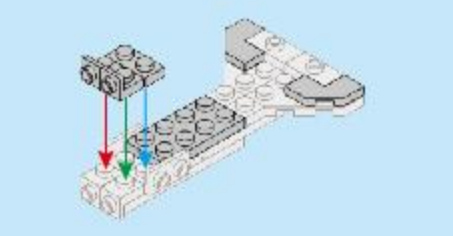

- 1x
- 1x
- 1x
- 1x

B5

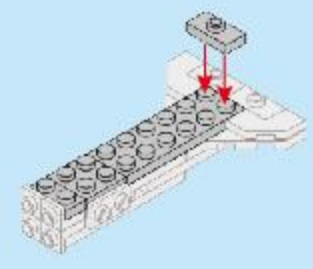

- 1x
- 1x
- 1x
- 2x
- 1x

B6

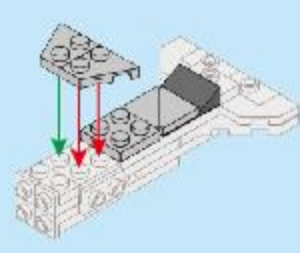

- 2x
- 2x

B7

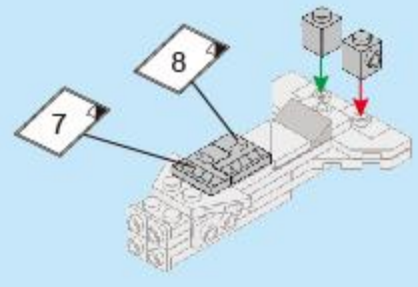

- 1x
- 1x
- 1x

B8

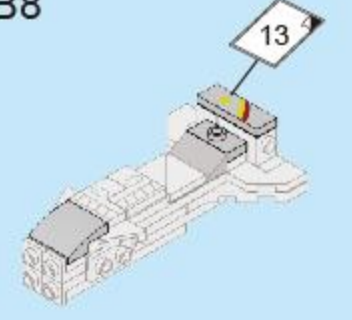

- 2x
- 2x
- 1x
- 1x
- 2x

B9

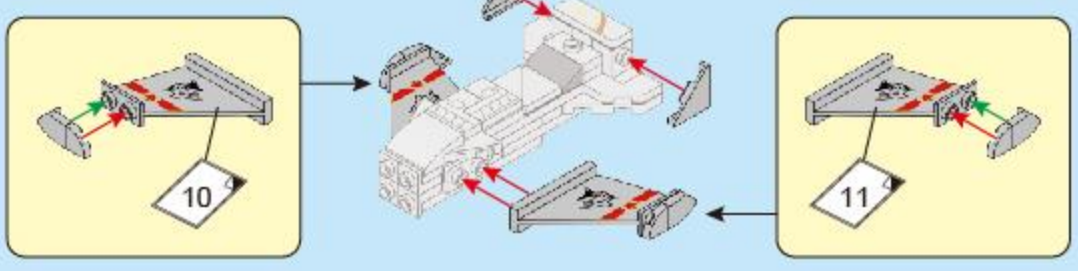

- 1x
- 3x
- 1x
- 2x
- 1x

B10

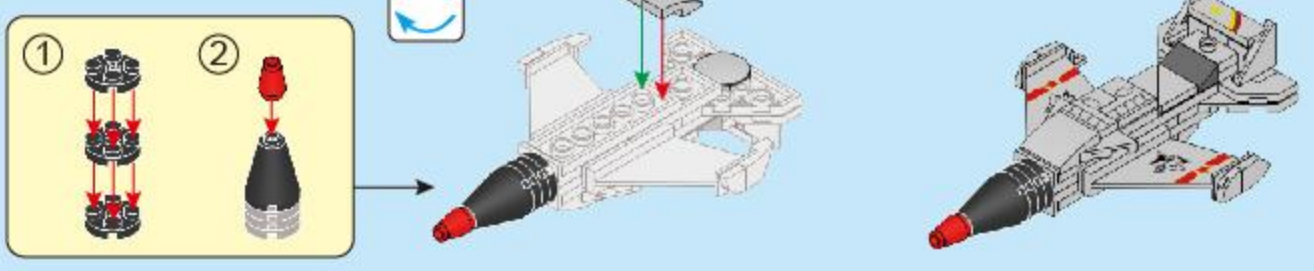





41

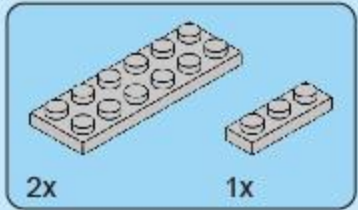
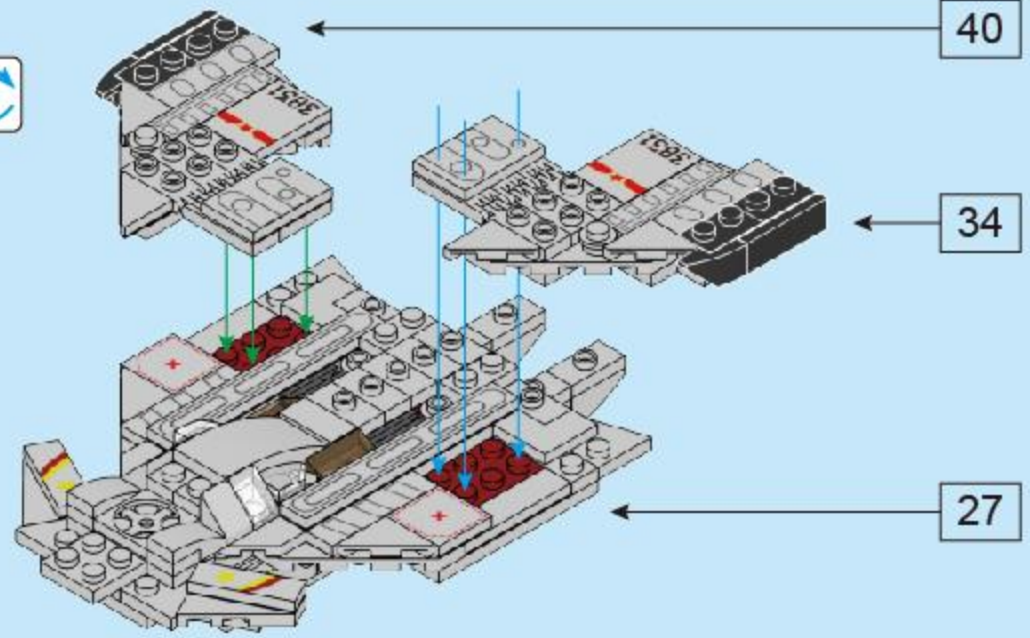

42

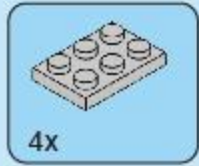

43

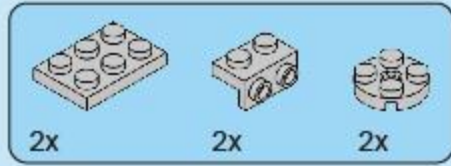

44

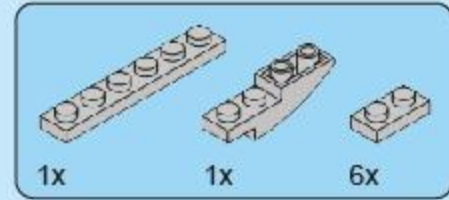

45

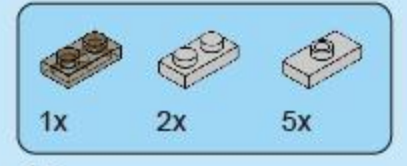

46

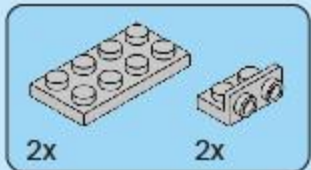
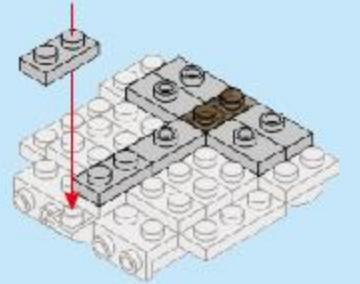
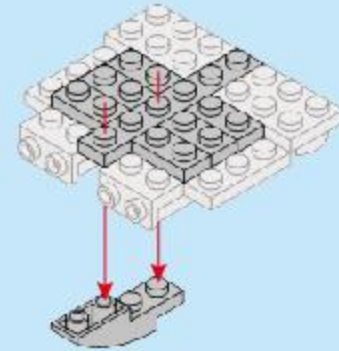
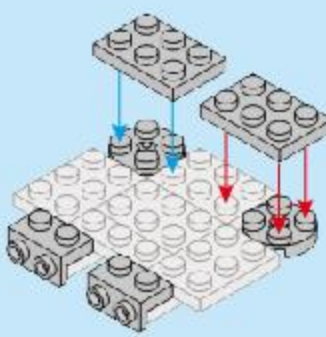
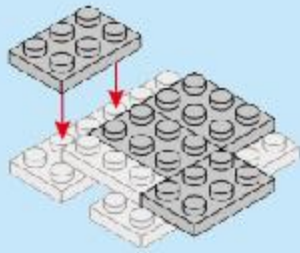
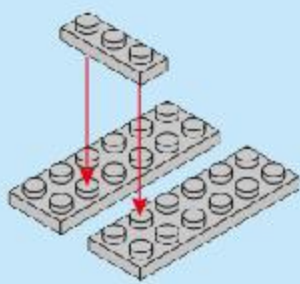

47

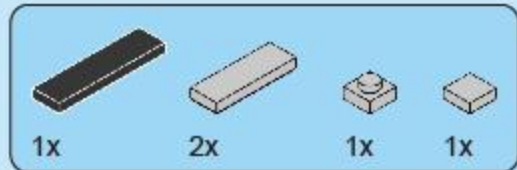

48

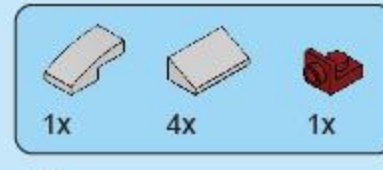

49



50

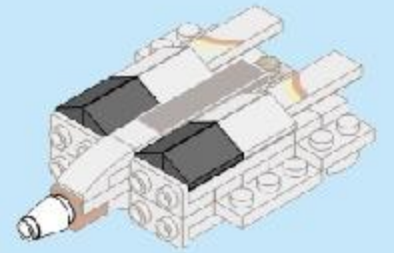
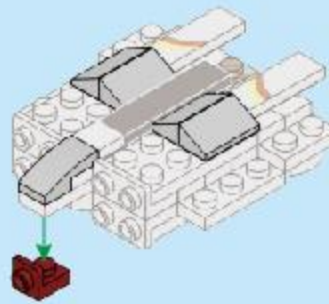
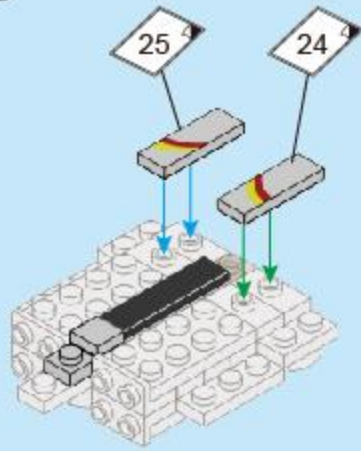
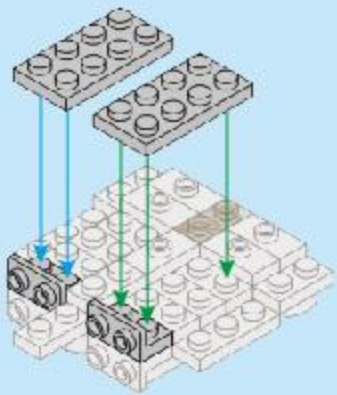

51

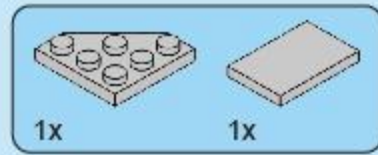

52

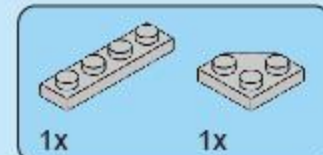

53



54

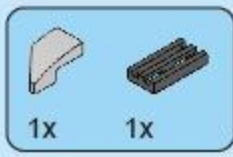
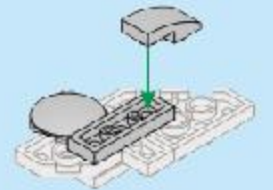
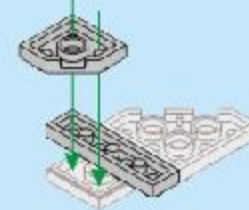
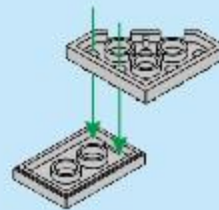
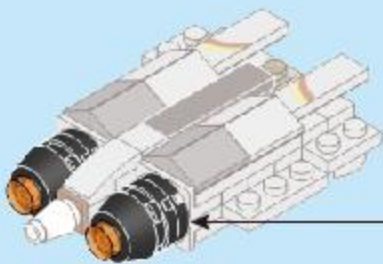

55

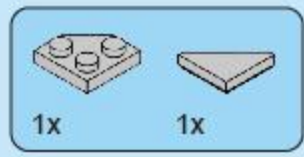

56

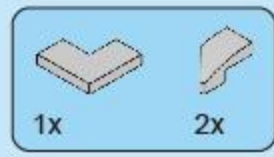

57

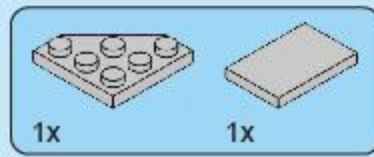

58

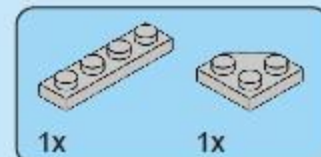

59



60

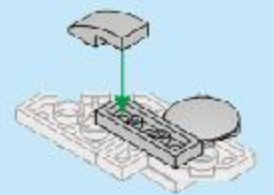
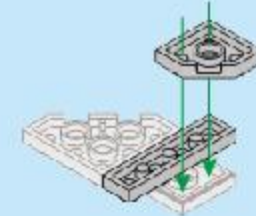
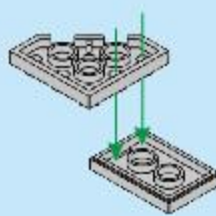
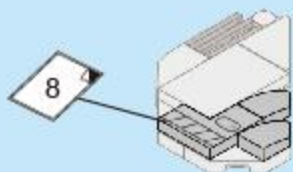
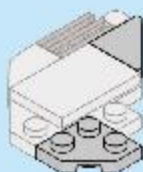
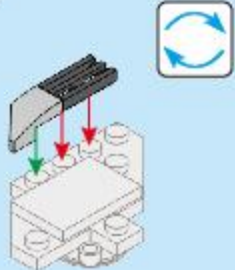



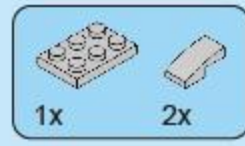
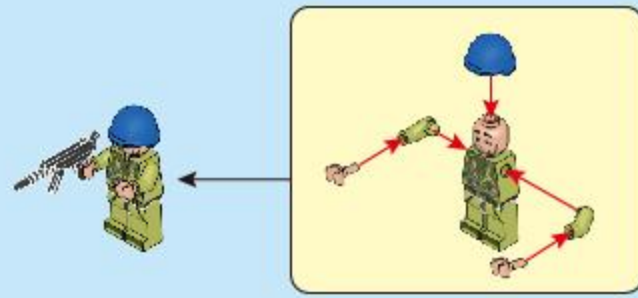

A1

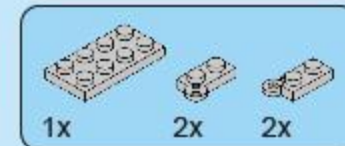
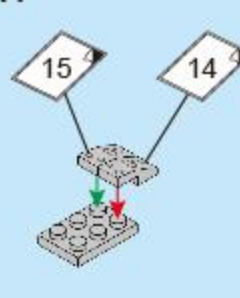

A2

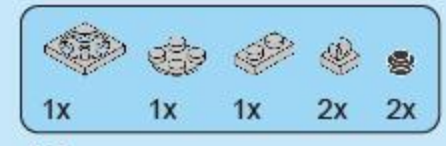
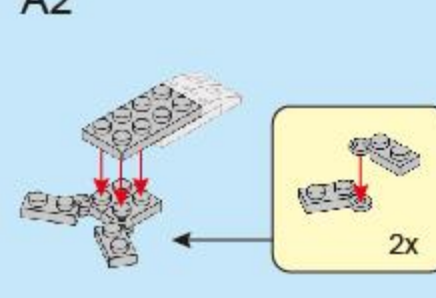

A3

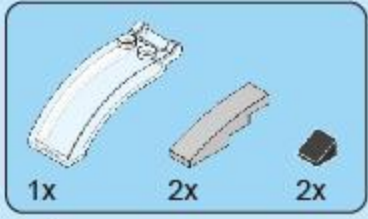
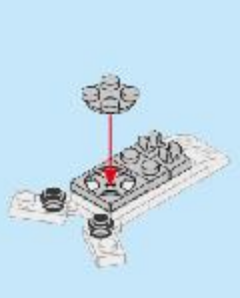

A4

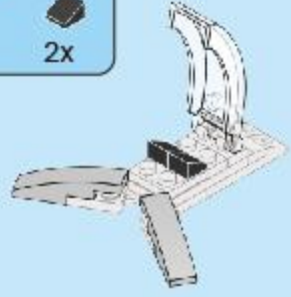

A5

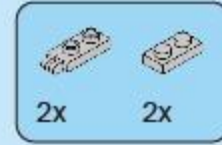
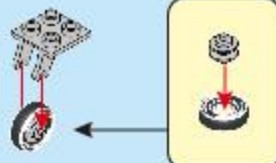

A6

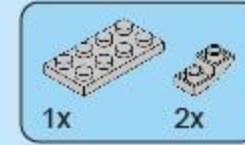

A7

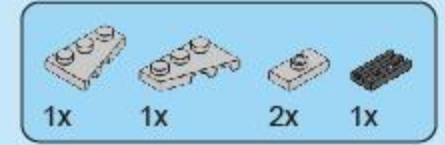
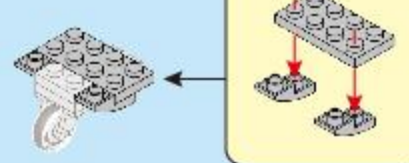

A8

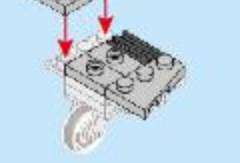

A9

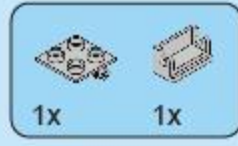
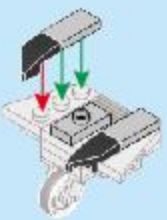

A10



A11



A12



A13

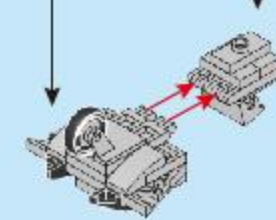

A14

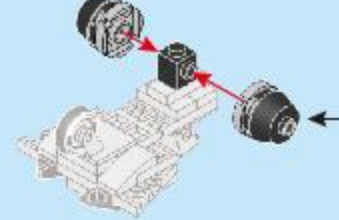

A15

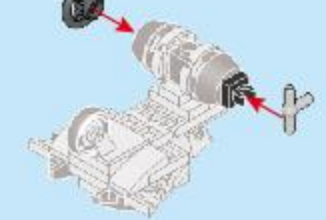

A16

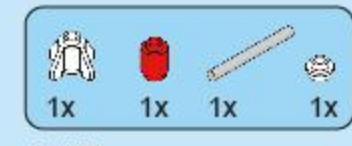
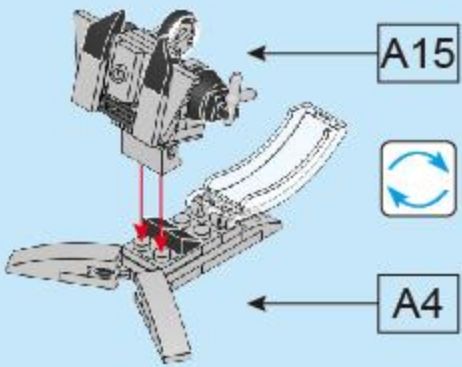

A17

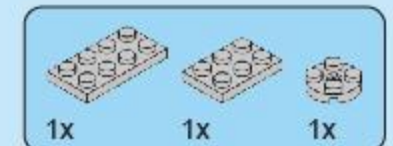
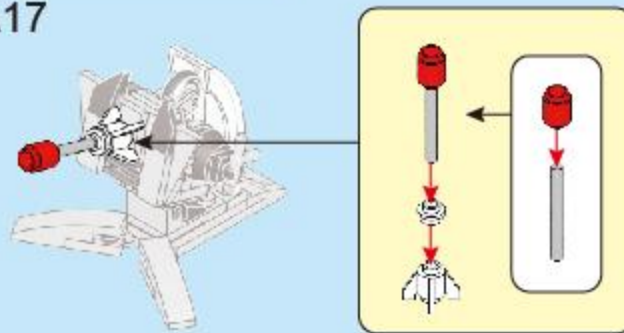

B1

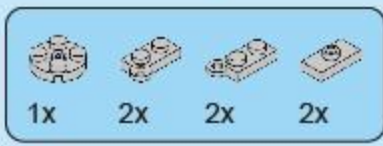
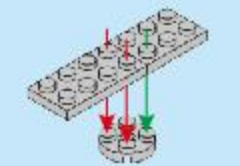

B2

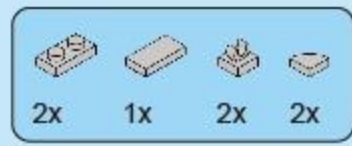
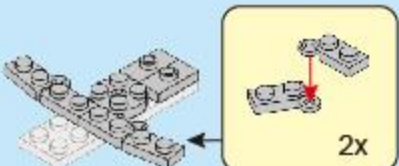

B3

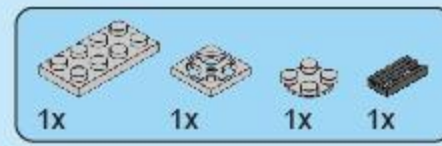
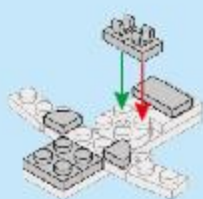

B4

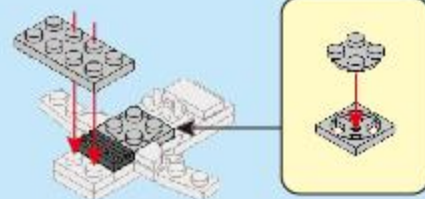

B5



B6

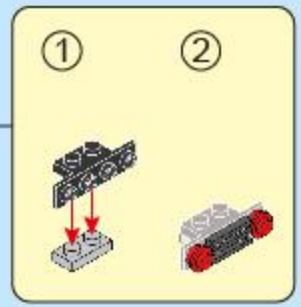
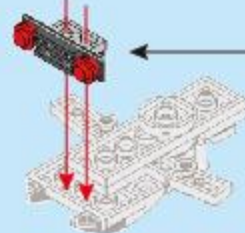

B7

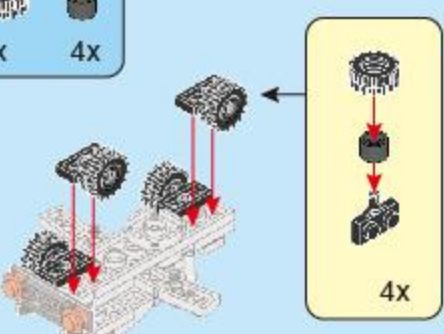

B8

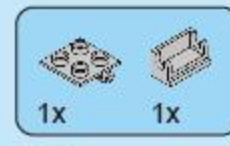
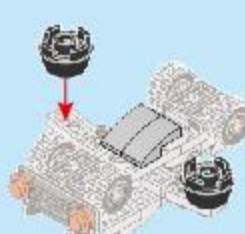

B9

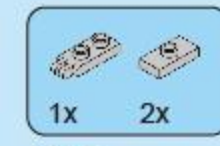

B10

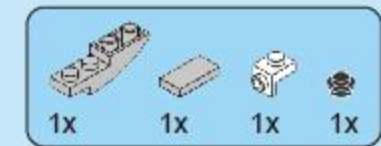

B11

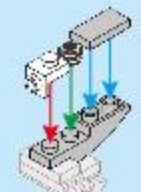

B12

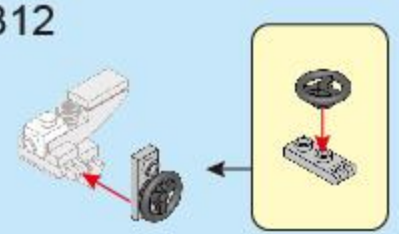

B13

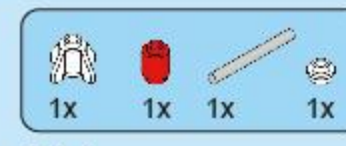
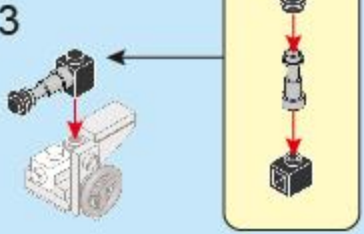

B14

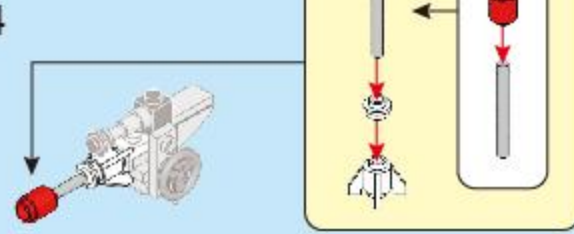

B15

B14

B8

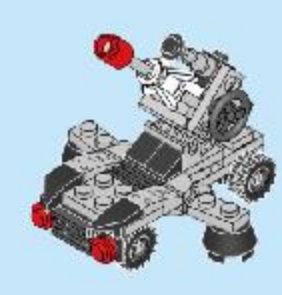
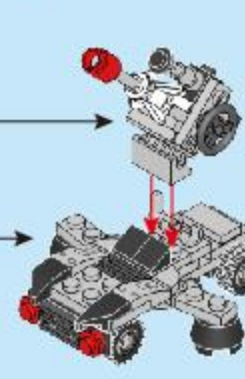





8IN1

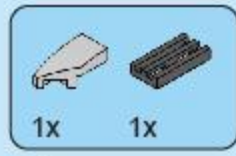

61

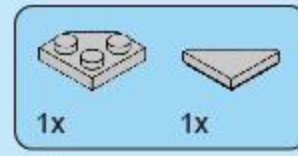
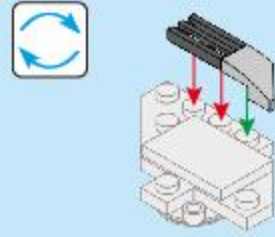

62

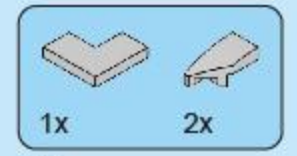

63

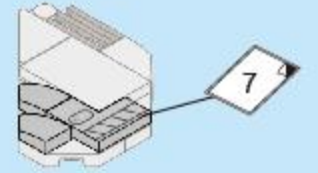

64

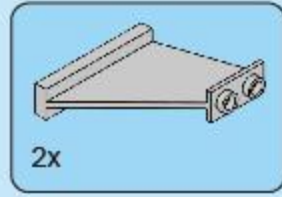
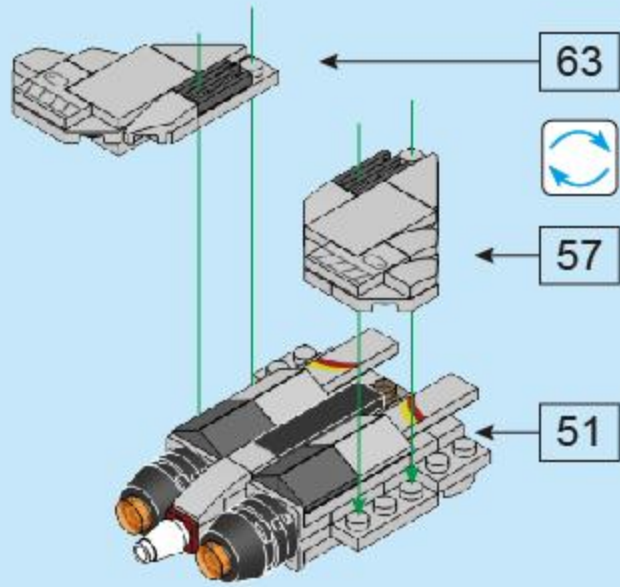

65

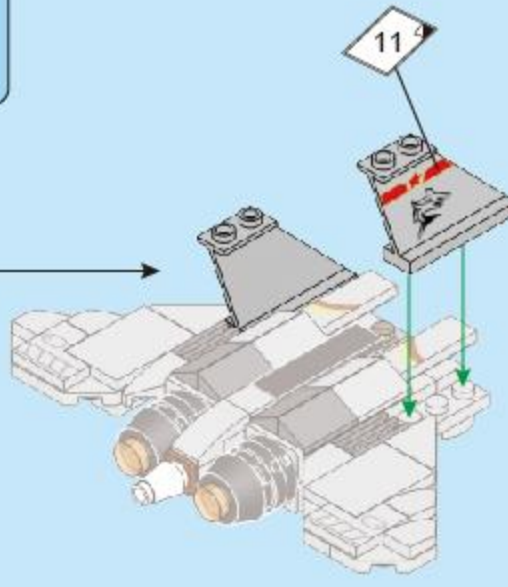
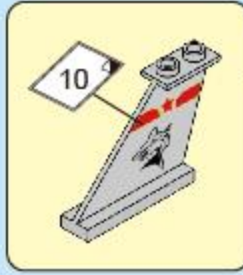

66

41

65

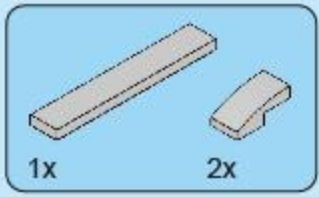
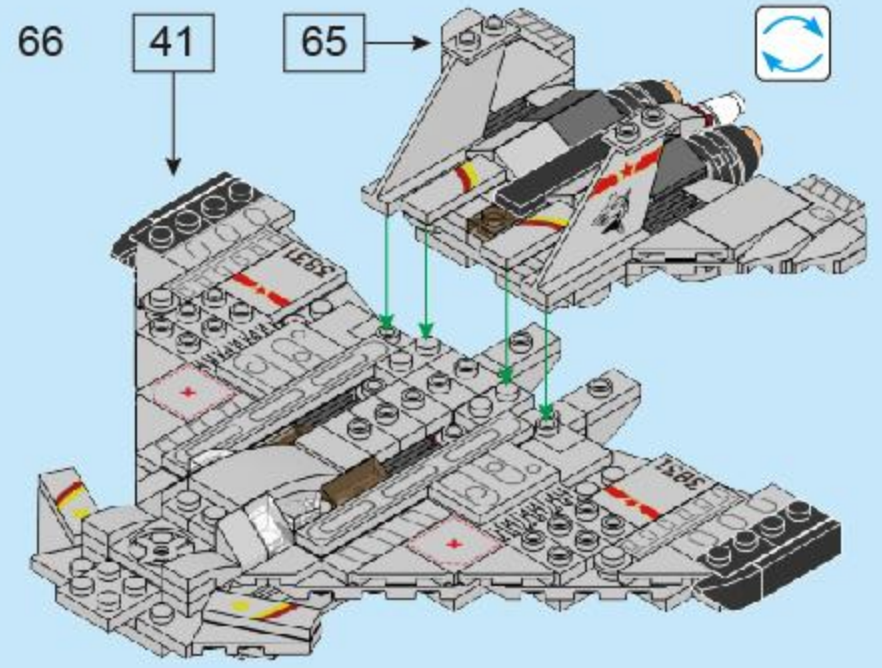

67

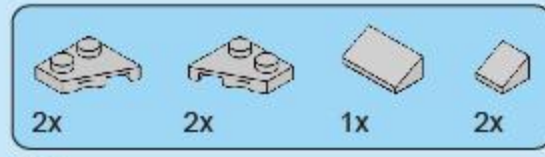
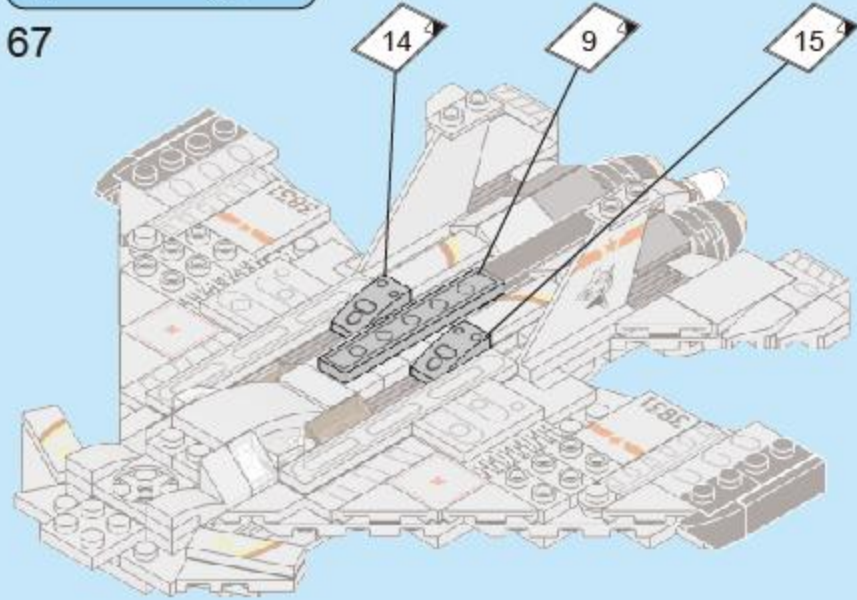

68

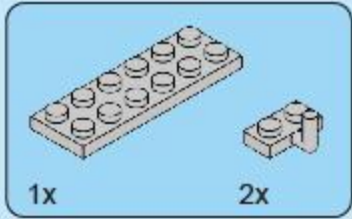
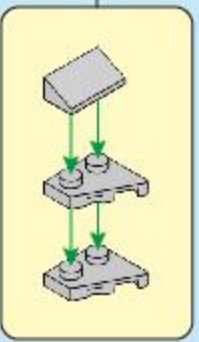
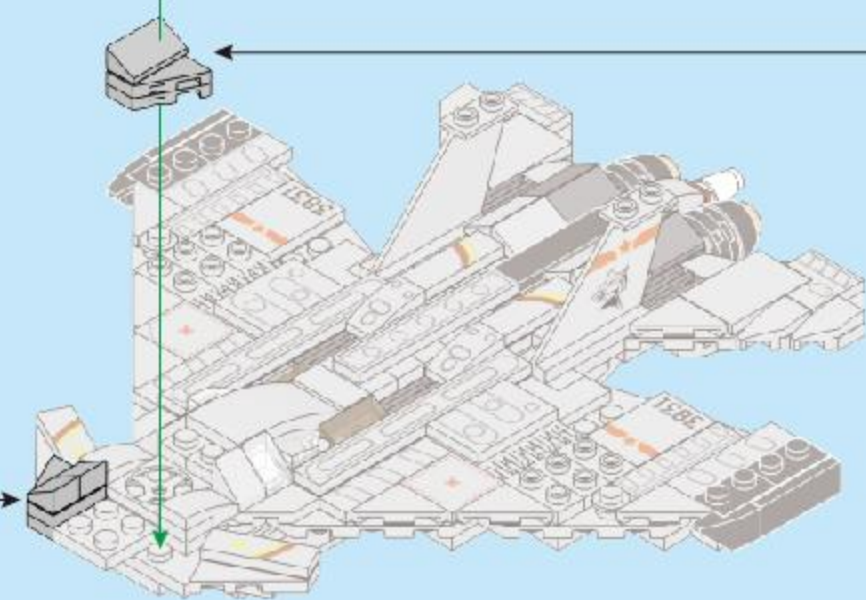
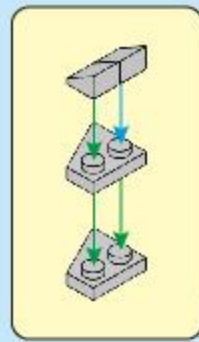

69

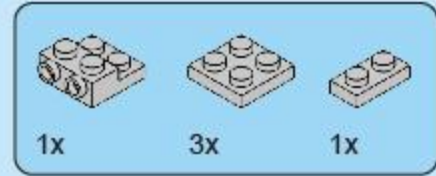
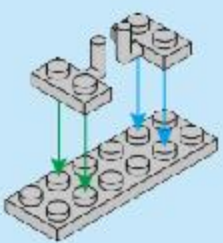

70

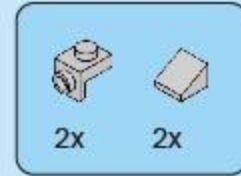
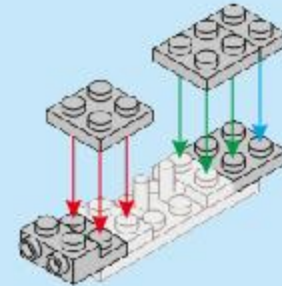

71

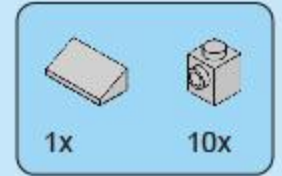
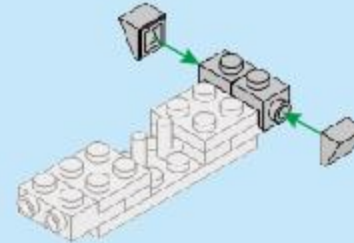

72

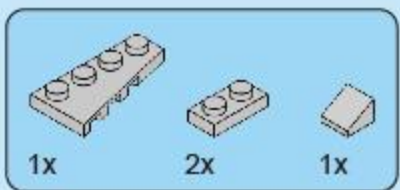
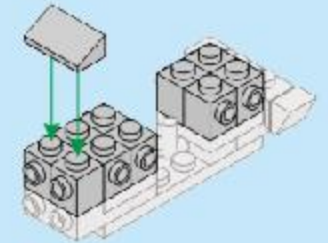

73

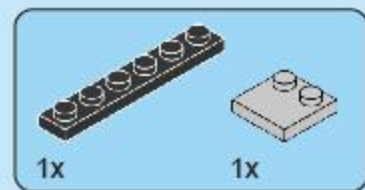
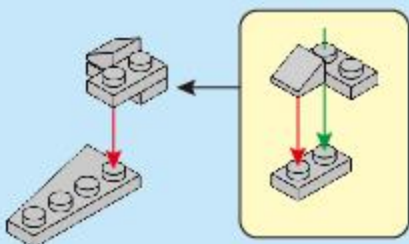

74

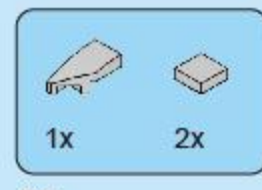
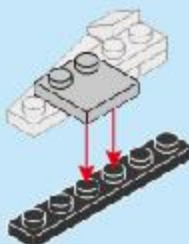

75

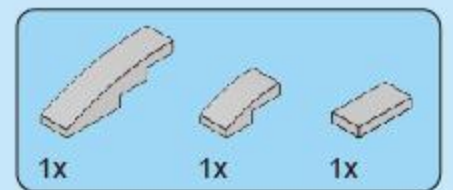

76





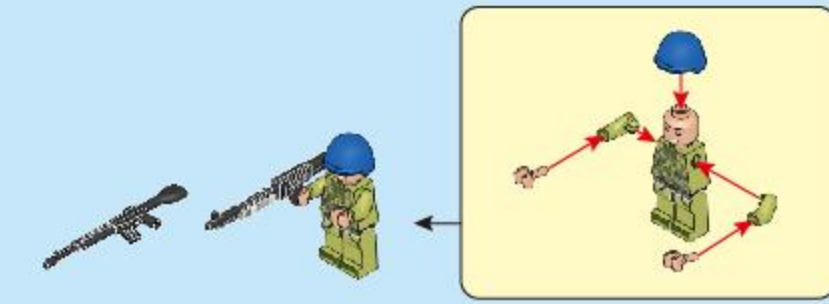
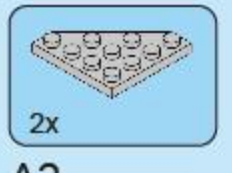
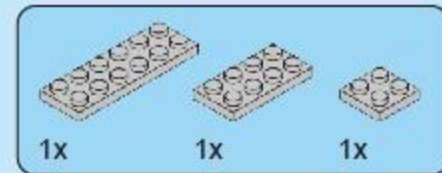

A1

A2

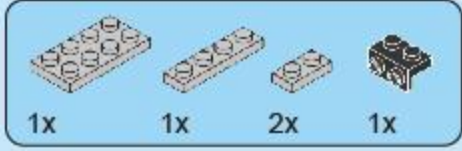
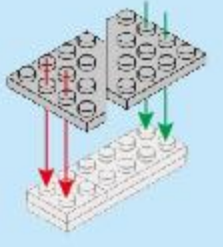
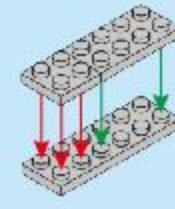

A3

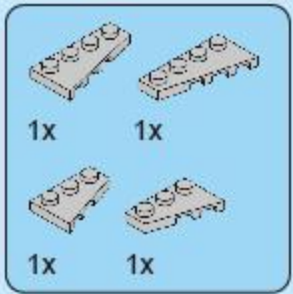
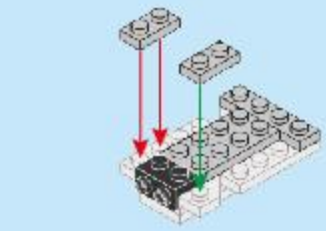

A8

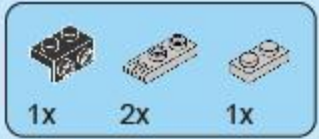
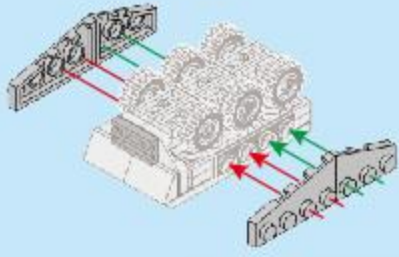

A12

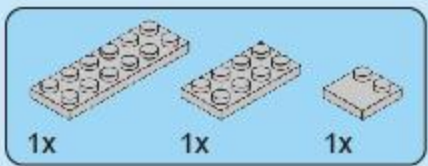
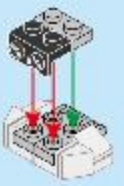

B1

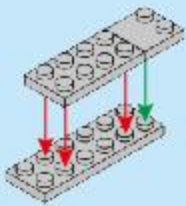

B6

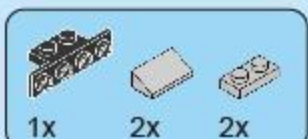
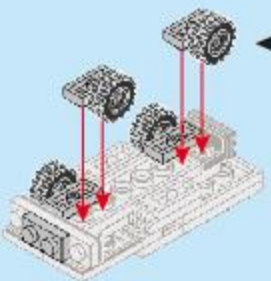

B10

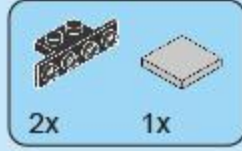
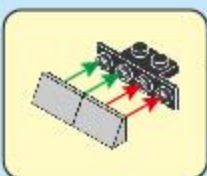

A4

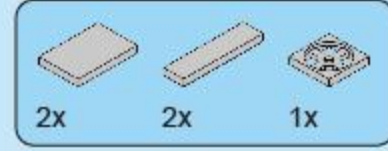
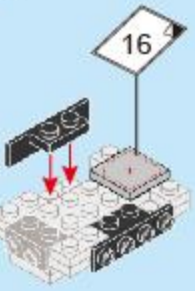

A5

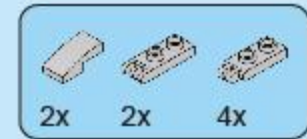
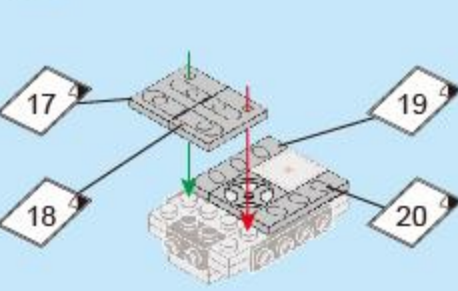

A9

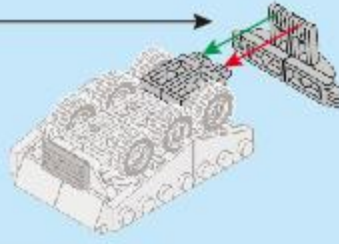
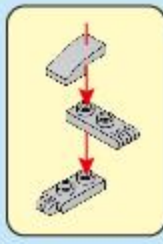

A6

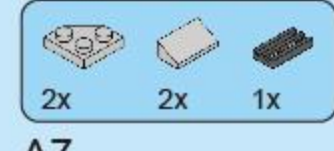
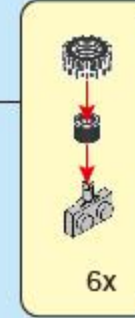

A7

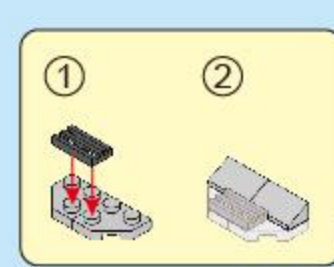

A11

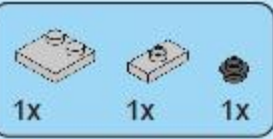
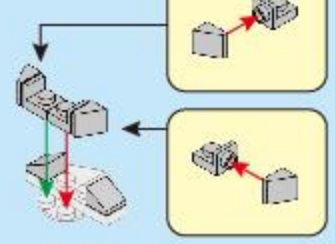

A13

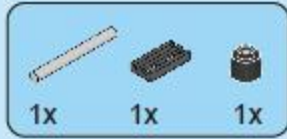

A14

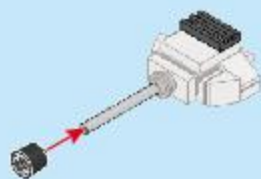

A15

A14



A9

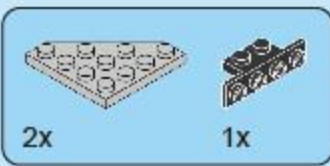
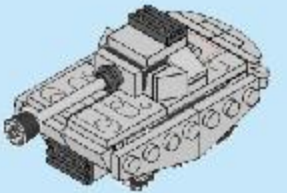
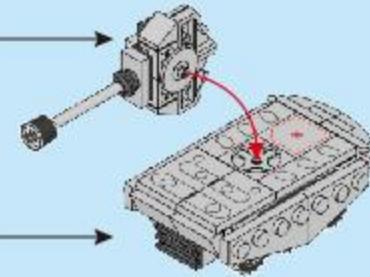

B2

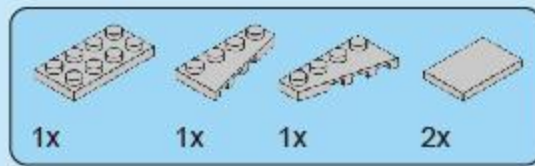
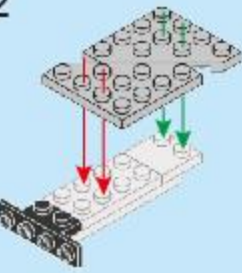

B3

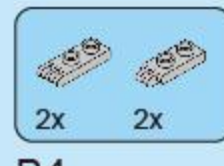
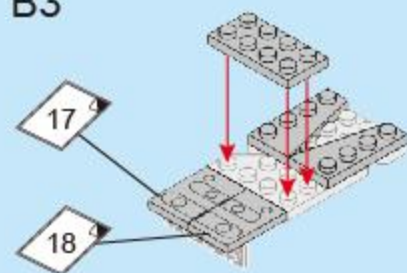

B4

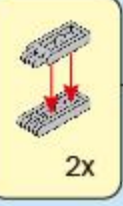

B5

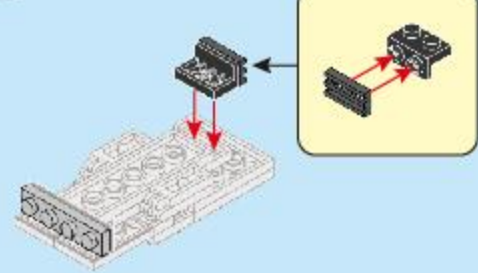

B7

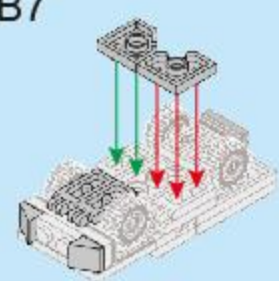

B8

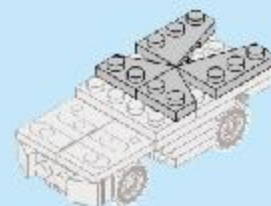

B9

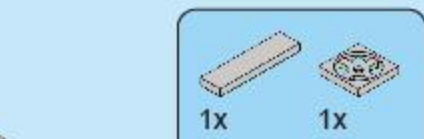
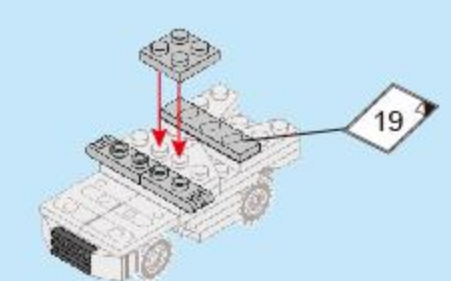

B11

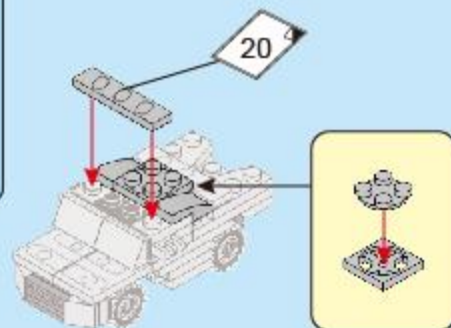
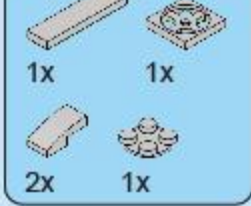

B12







8IN1

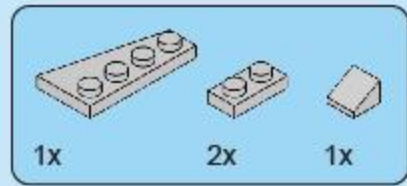

77

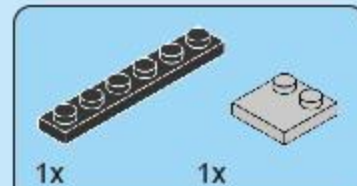
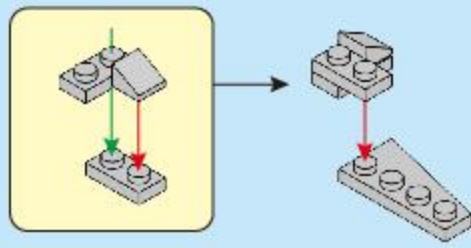

78

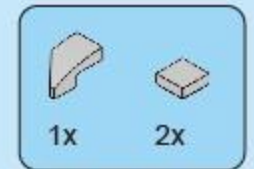
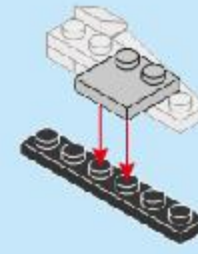

79

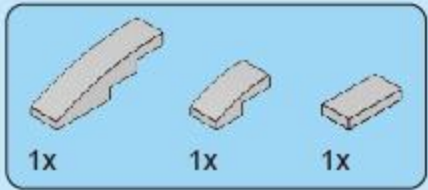
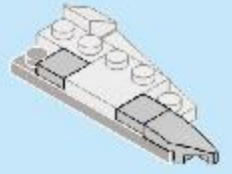

80

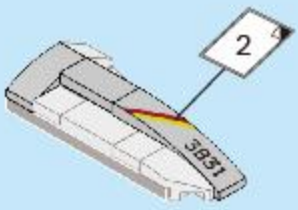

81

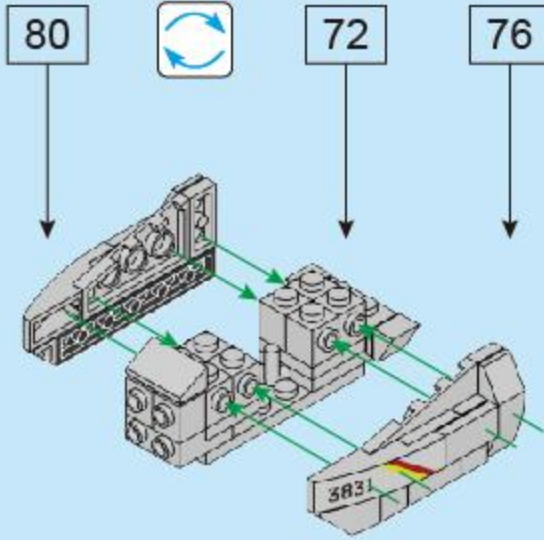

82

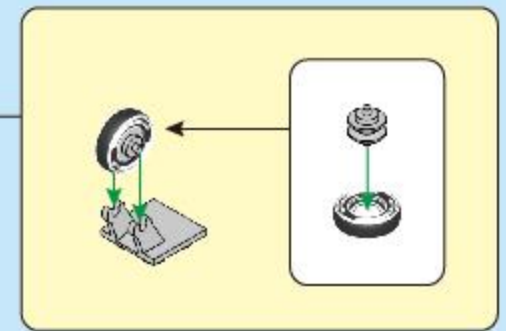
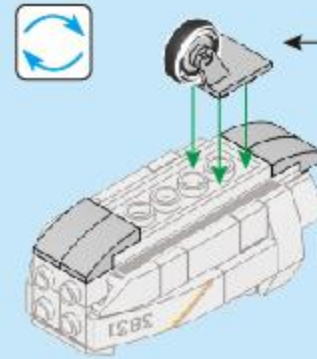

83

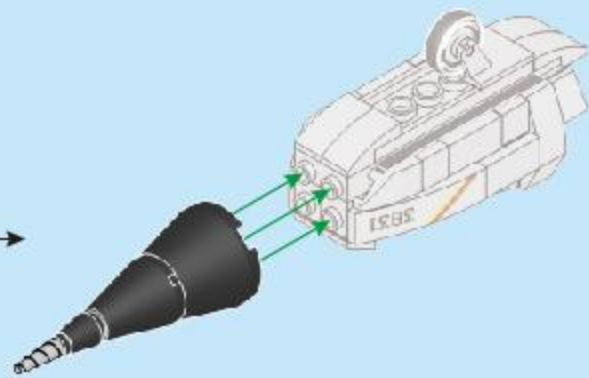

84

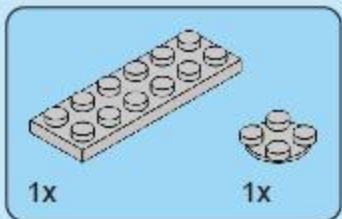
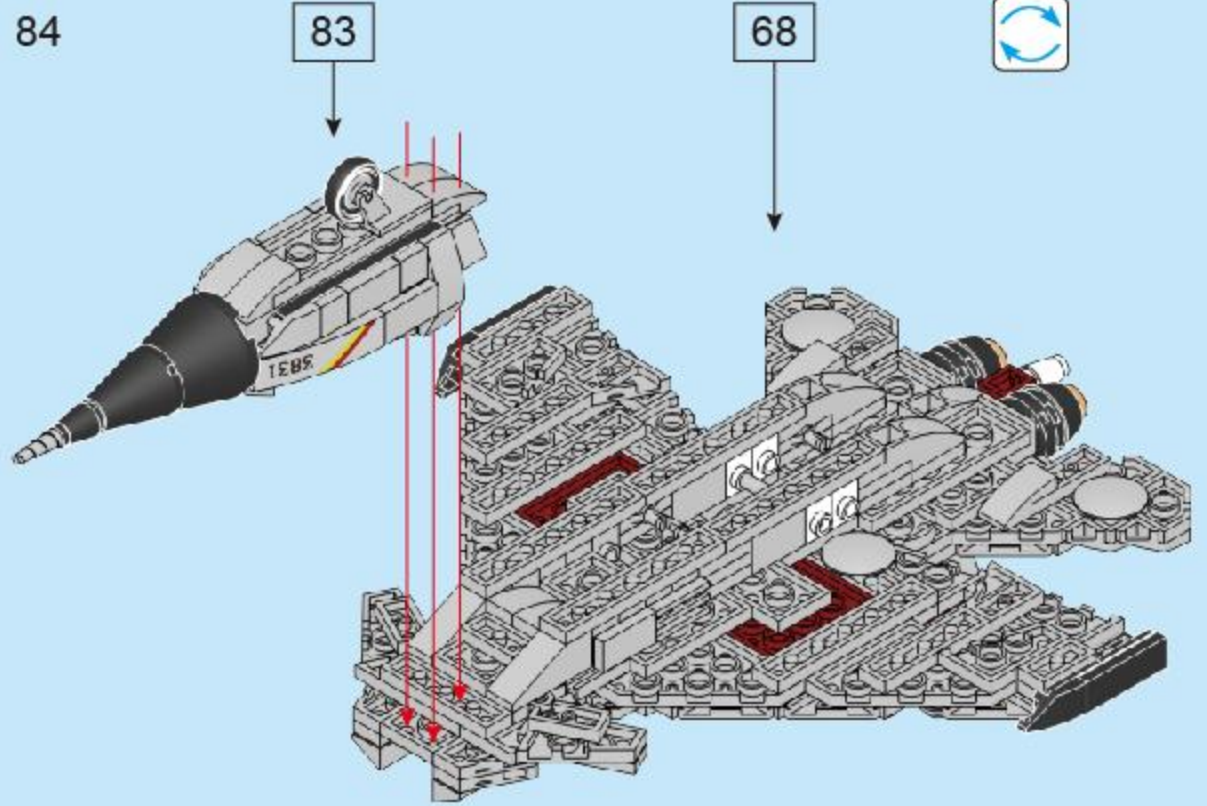

85

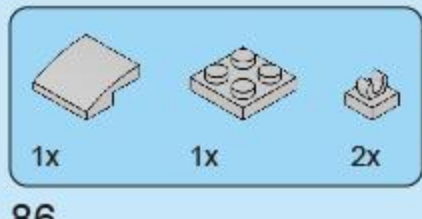
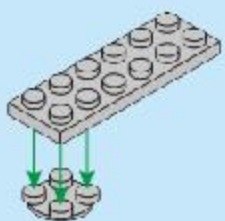

86

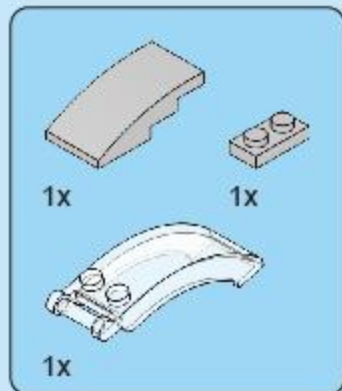
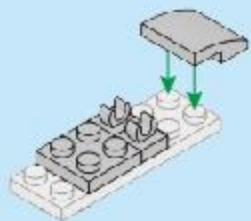

87

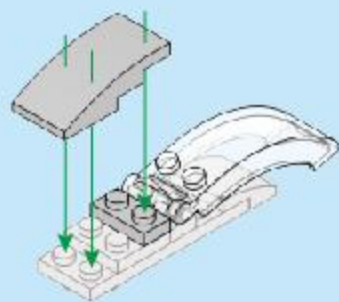

88

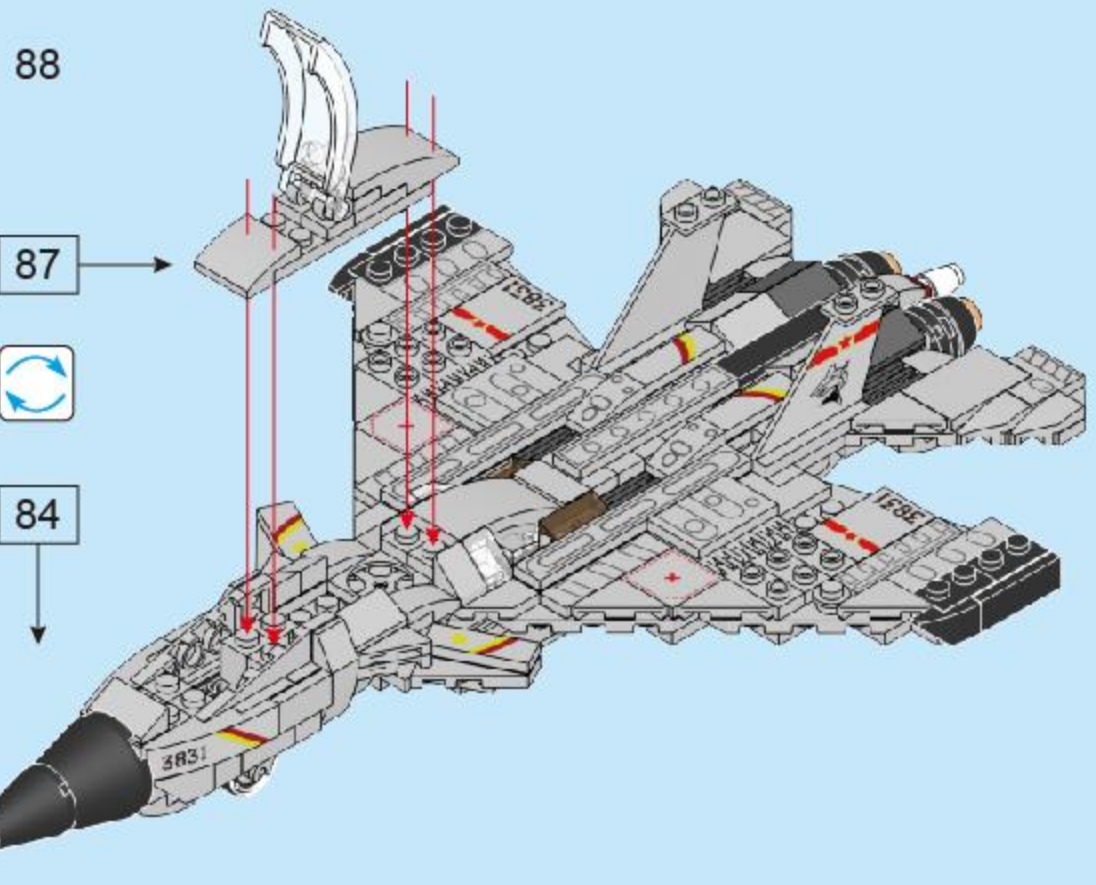





- 1x
- 1x
- 1x
- 1x
- 2x

- 1x
- 2x
- 2x

- 6x

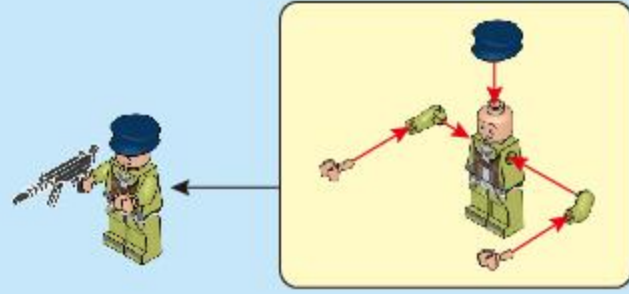

A1

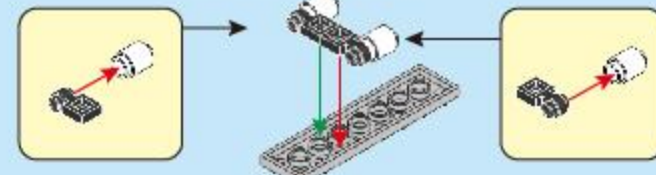

A2

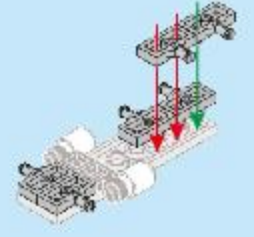

- 2x
- 6x
- 6x

A3

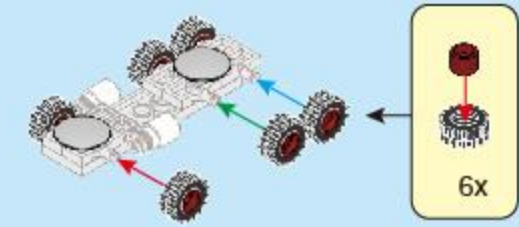

- 1x
- 1x
- 2x
- 1x

A4

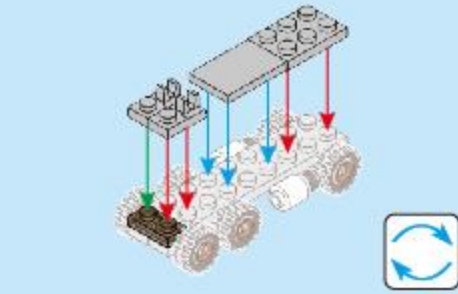

- 1x
- 1x
- 1x
- 4x

A5

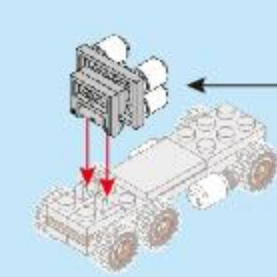

- 1x
- 1x
- 1x
- 2x

A6

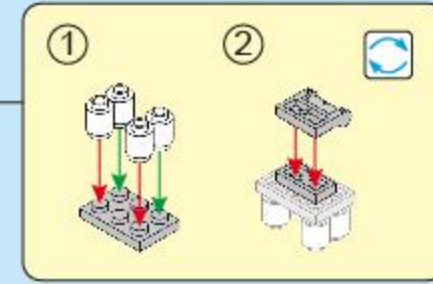

- 1x
- 2x
- 2x

A7

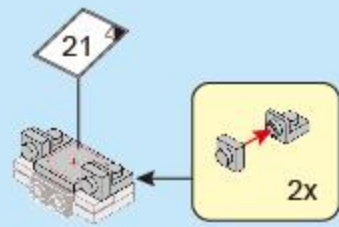

- 2x
- 2x

A8

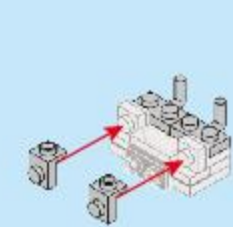

- 1x
- 2x

A9

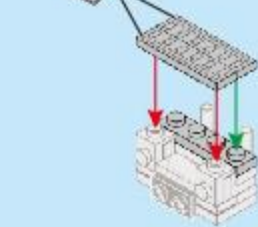

- 2x
- 2x

A10

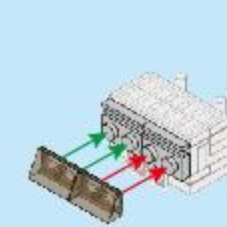

- 1x
- 2x
- 2x
- 1x
- 2x

A11

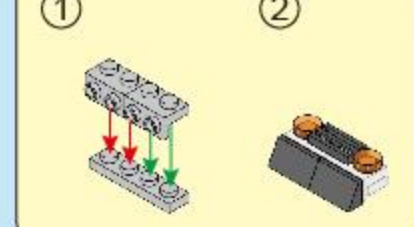

A12

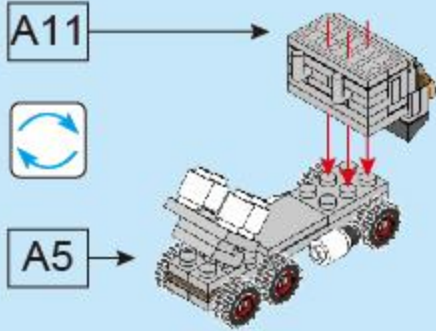

- 1x
- 1x
- 2x
- 1x

B1

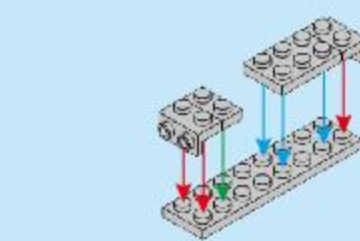

- 1x
- 2x

B2

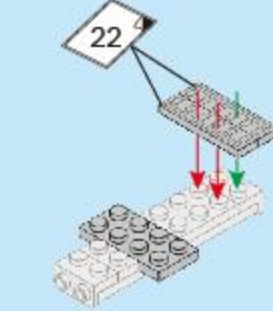

- 2x
- 1x
- 1x

B3

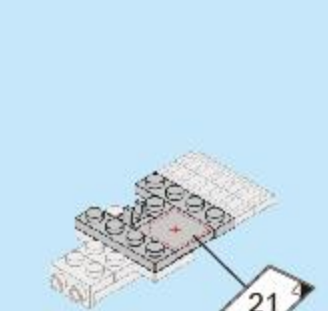

- 1x
- 1x
- 2x

B4

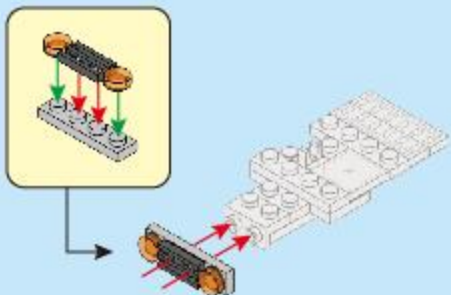

- 1x
- 1x
- 2x

B5

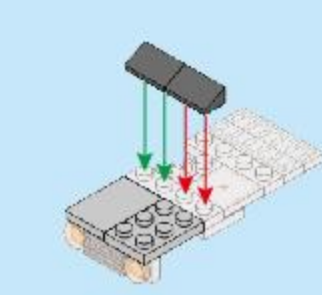

- 1x
- 1x
- 1x

B6

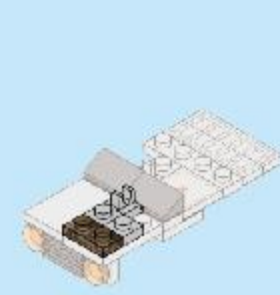

- 1x
- 1x
- 1x
- 1x

B7

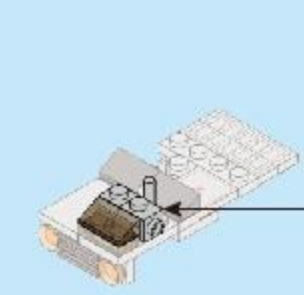

- 1x
- 2x

B8

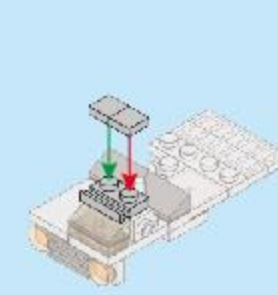

- 2x

B9

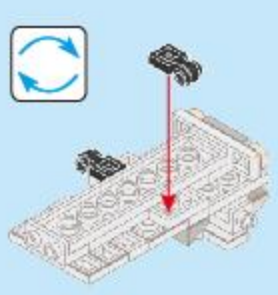

- 6x

B10

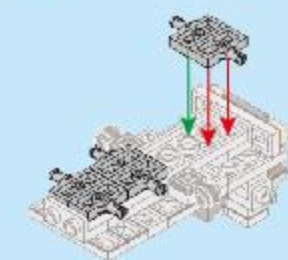

- 2x
- 6x
- 6x

B11

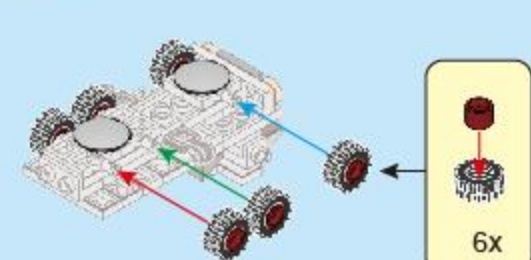

- 1x
- 1x
- 1x
- 6x

B12

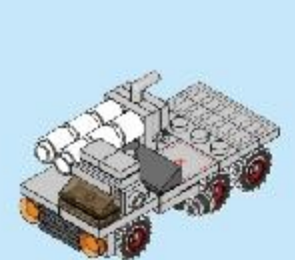
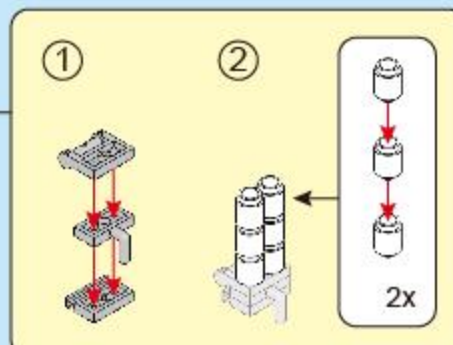
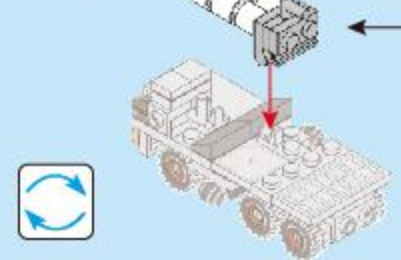



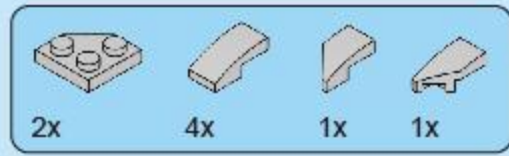

89

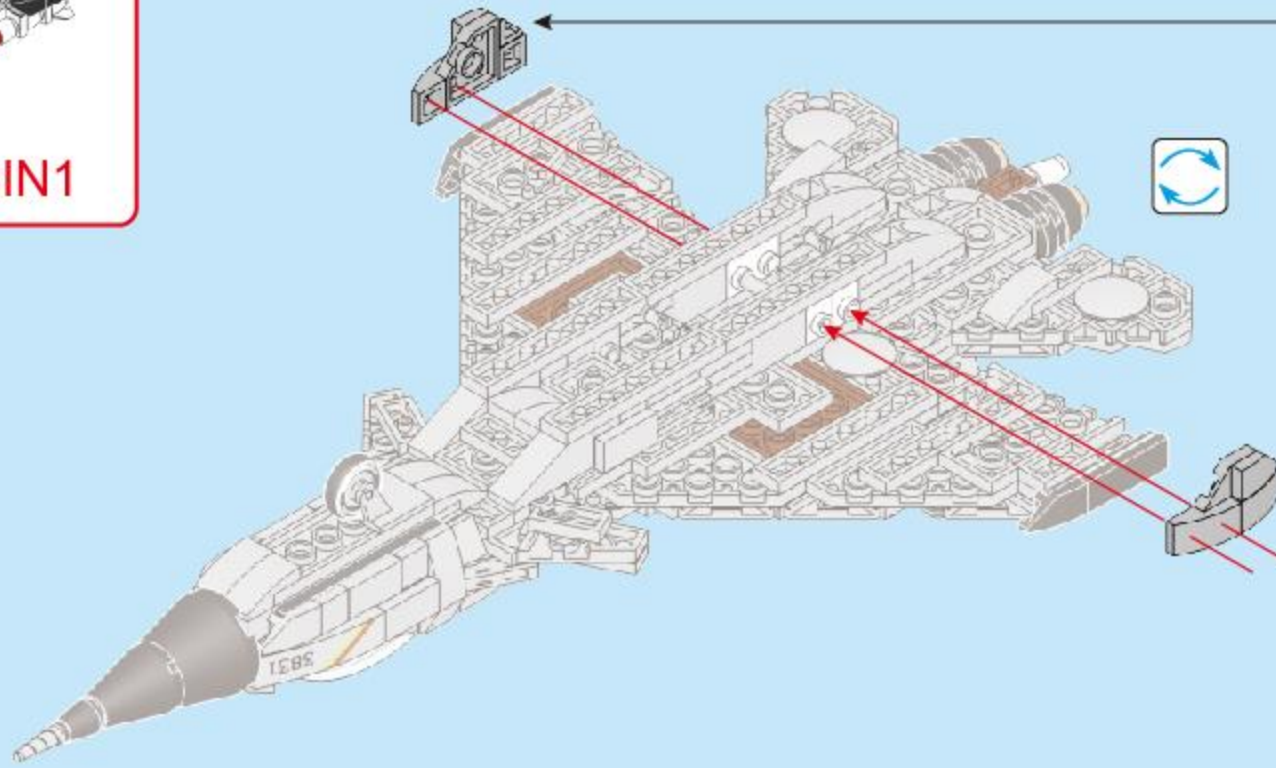
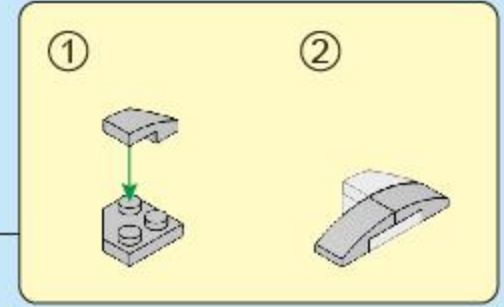
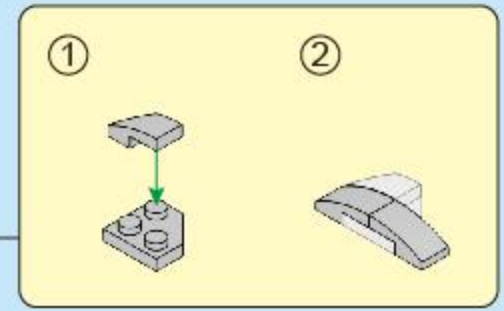

90

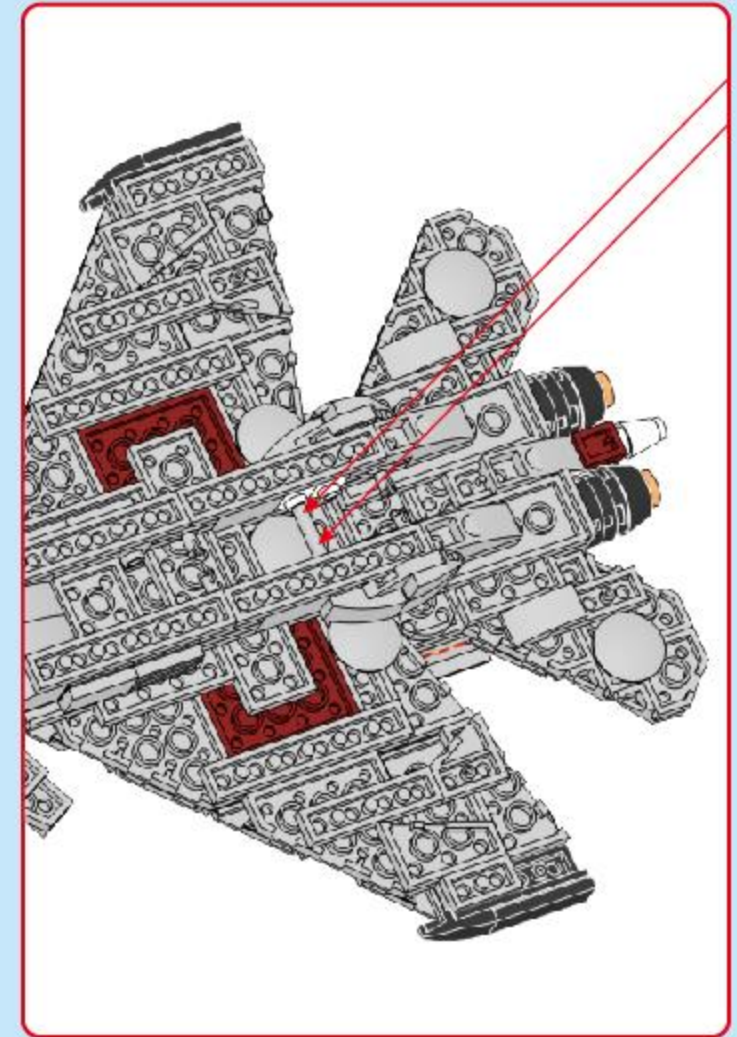
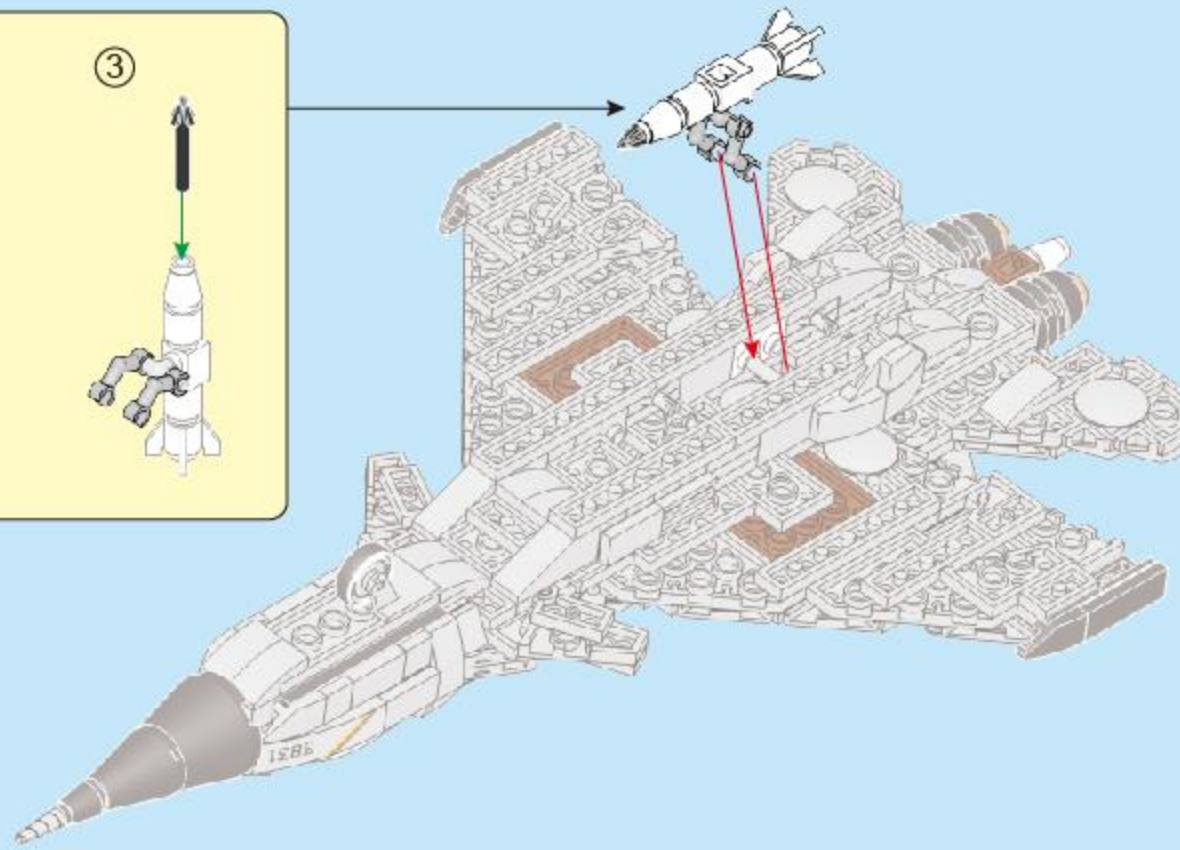
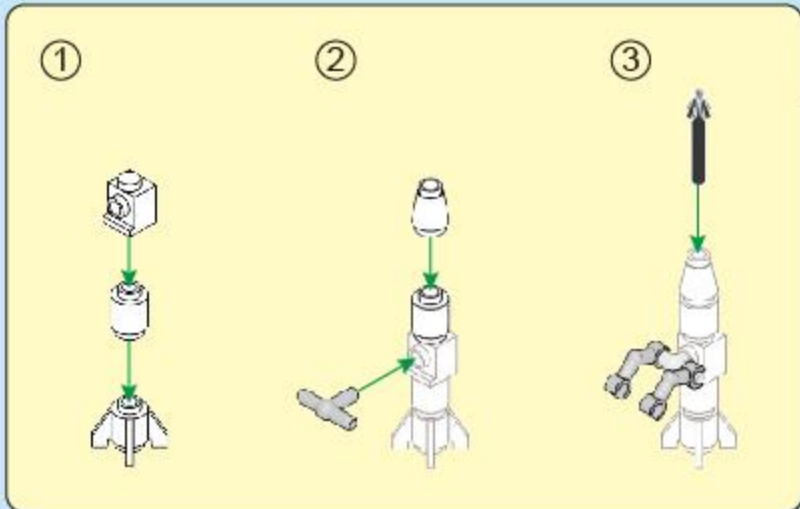

91

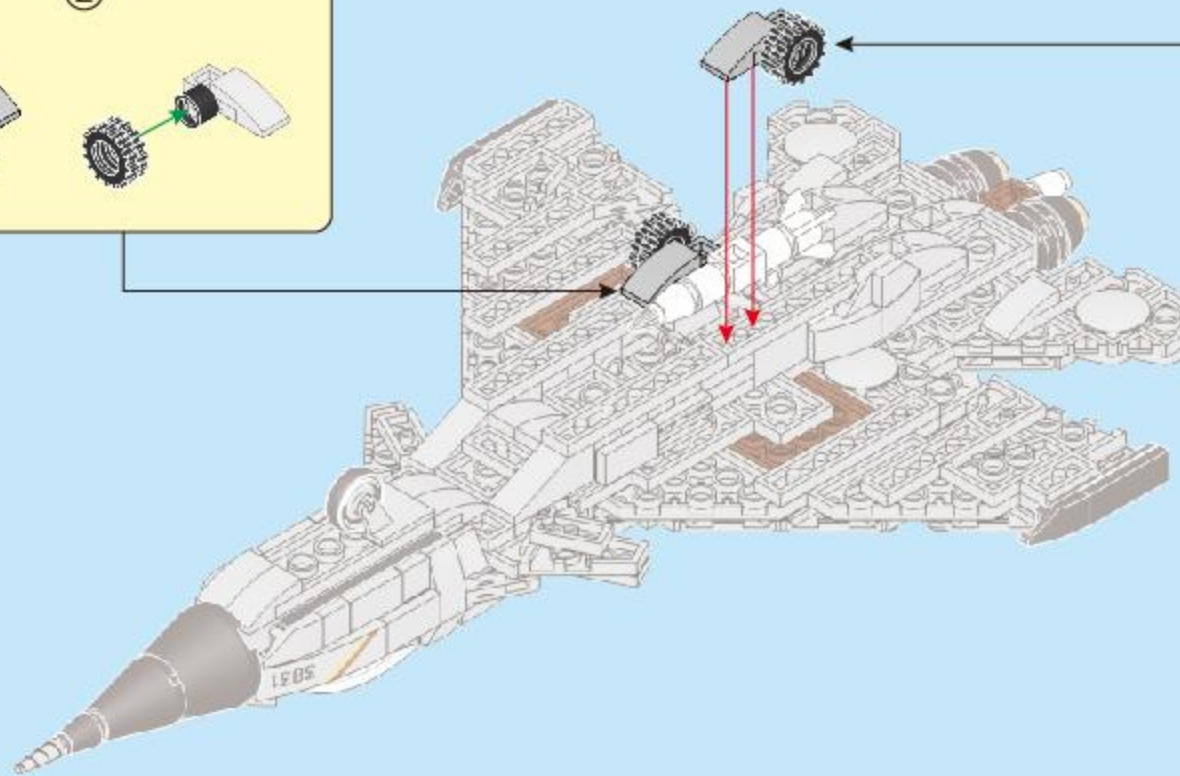
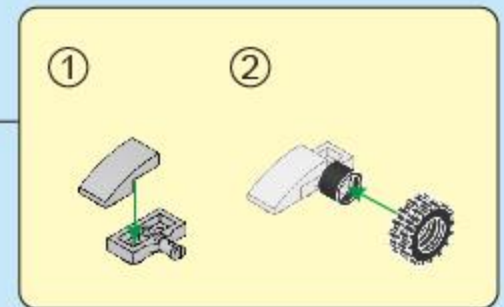
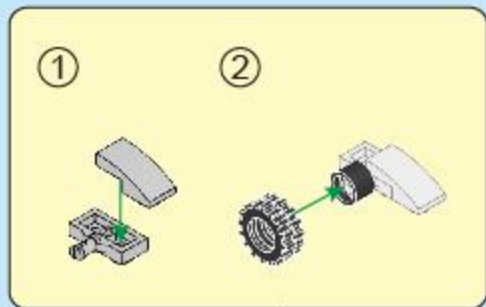



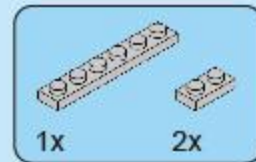
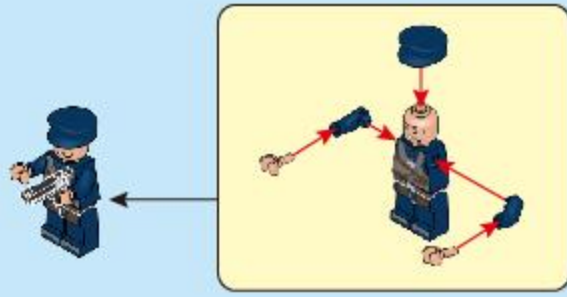

A1

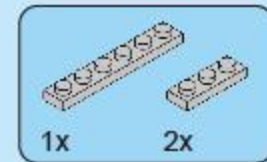
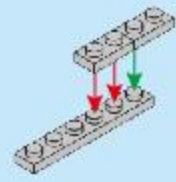

A2

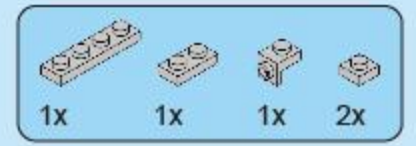
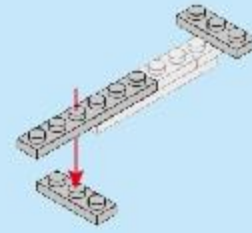

A3

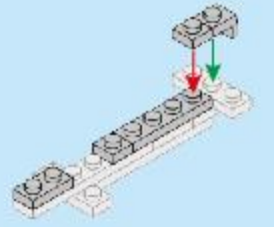

A4

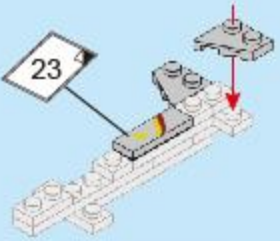

A5

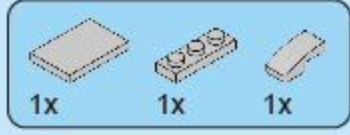
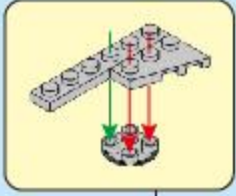
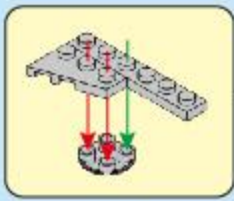

A6

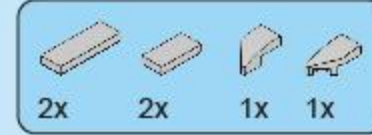
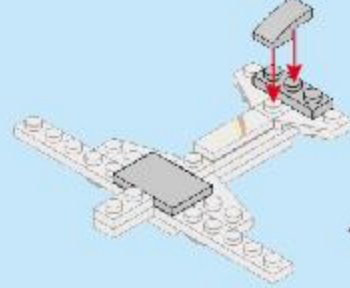

A7

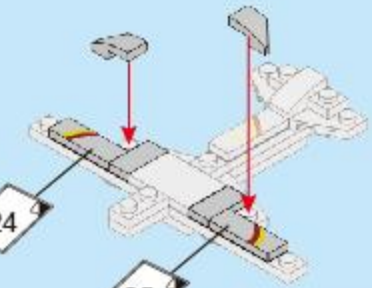

A8

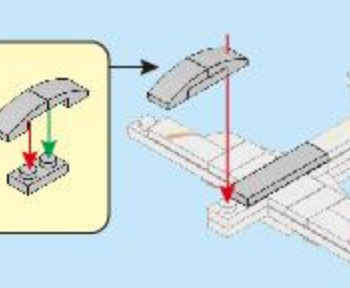

A9



A10

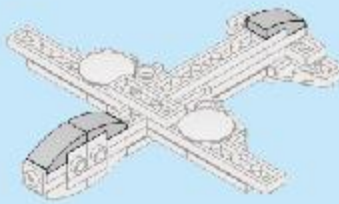

A11

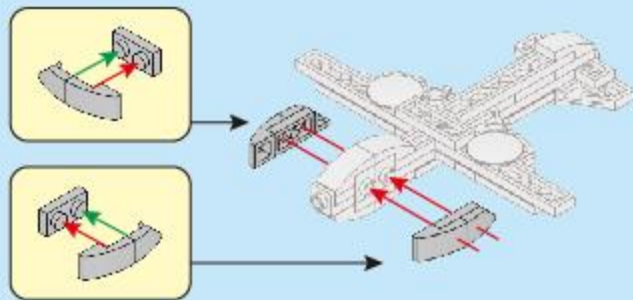

A12

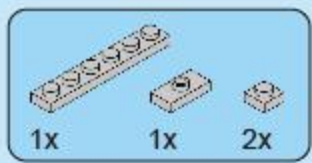
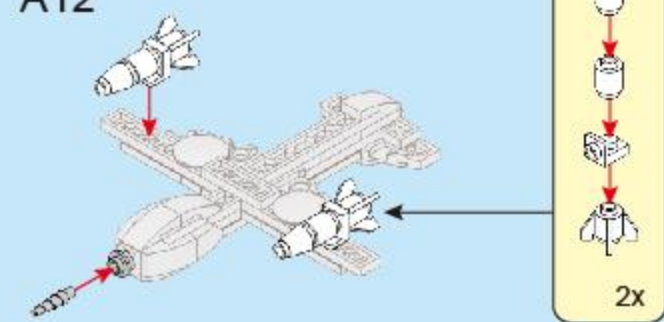

B1

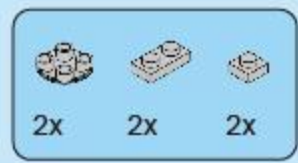
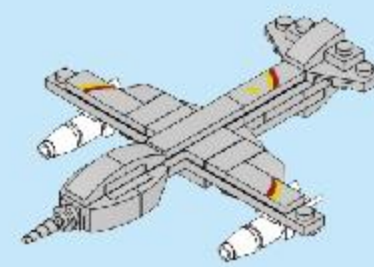

B2

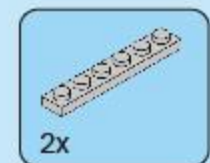
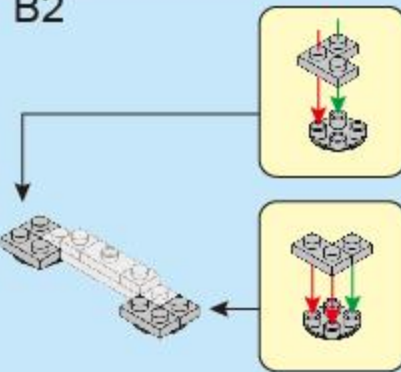

B3

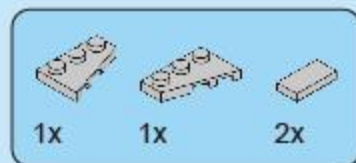
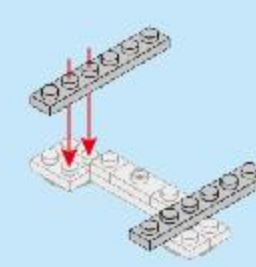

B4

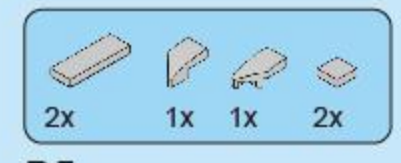
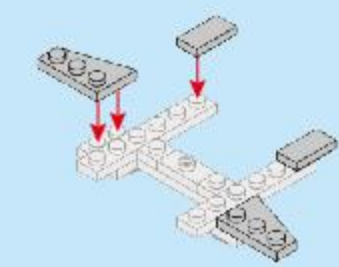

B5

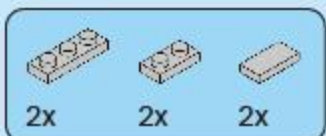
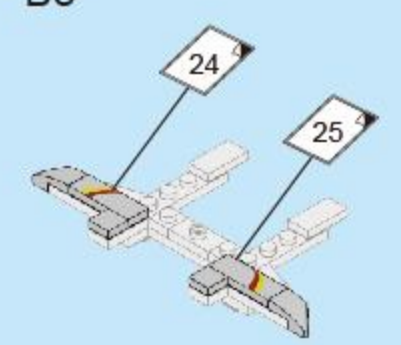

B6

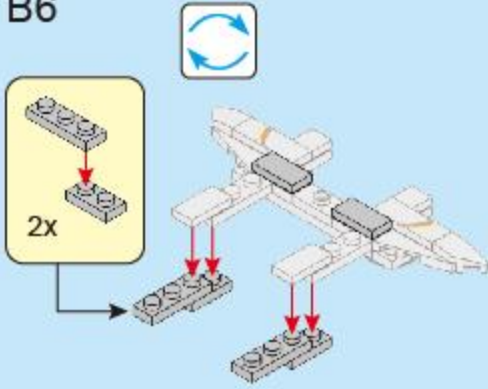

B7

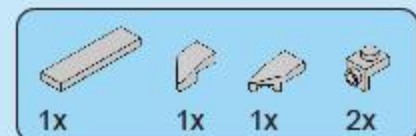
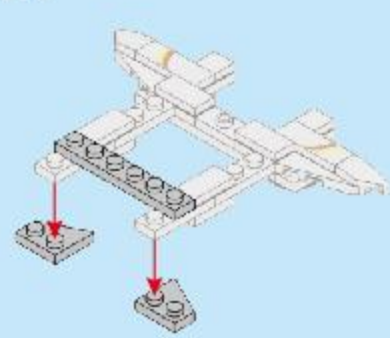

B8

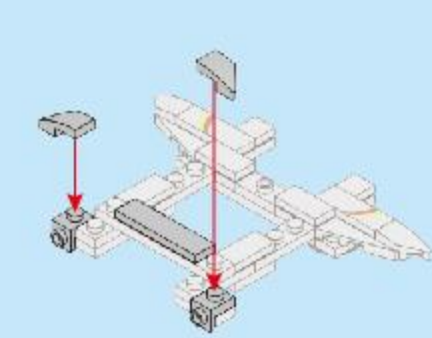

B9

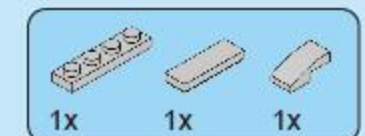
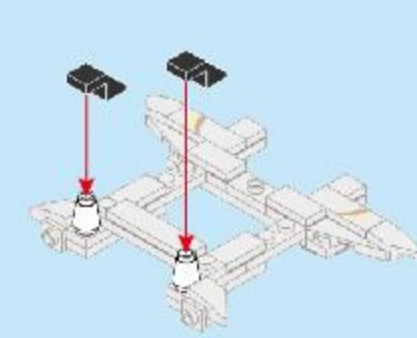

B10



B11

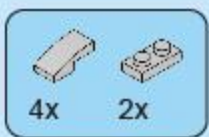
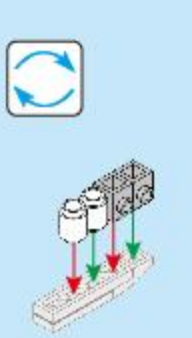

B12

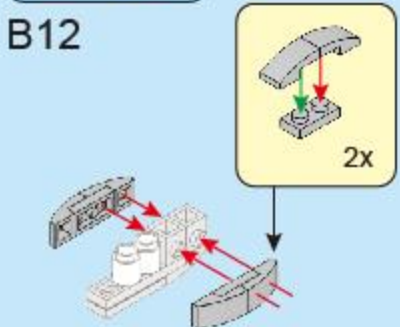

B13

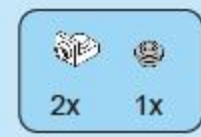
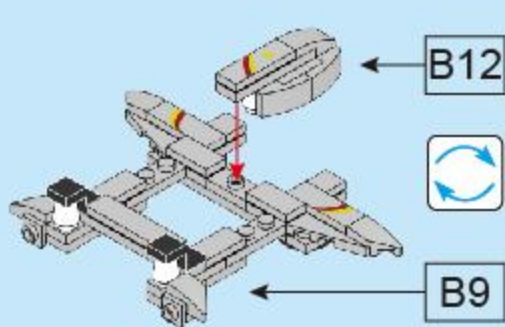

B14



B15

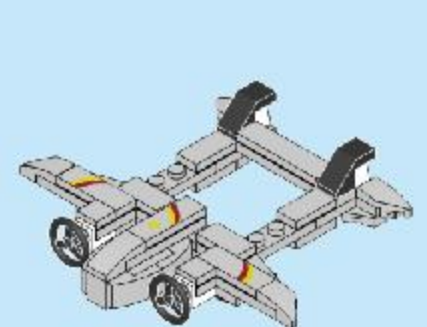
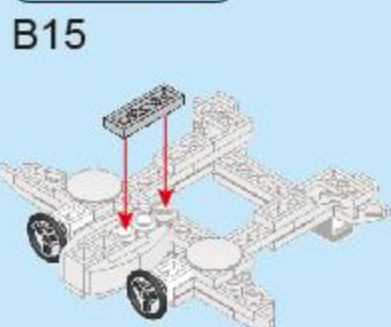





92

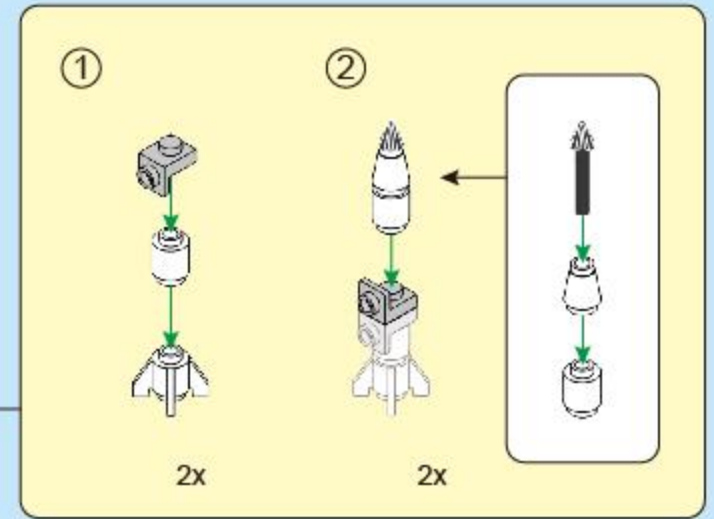
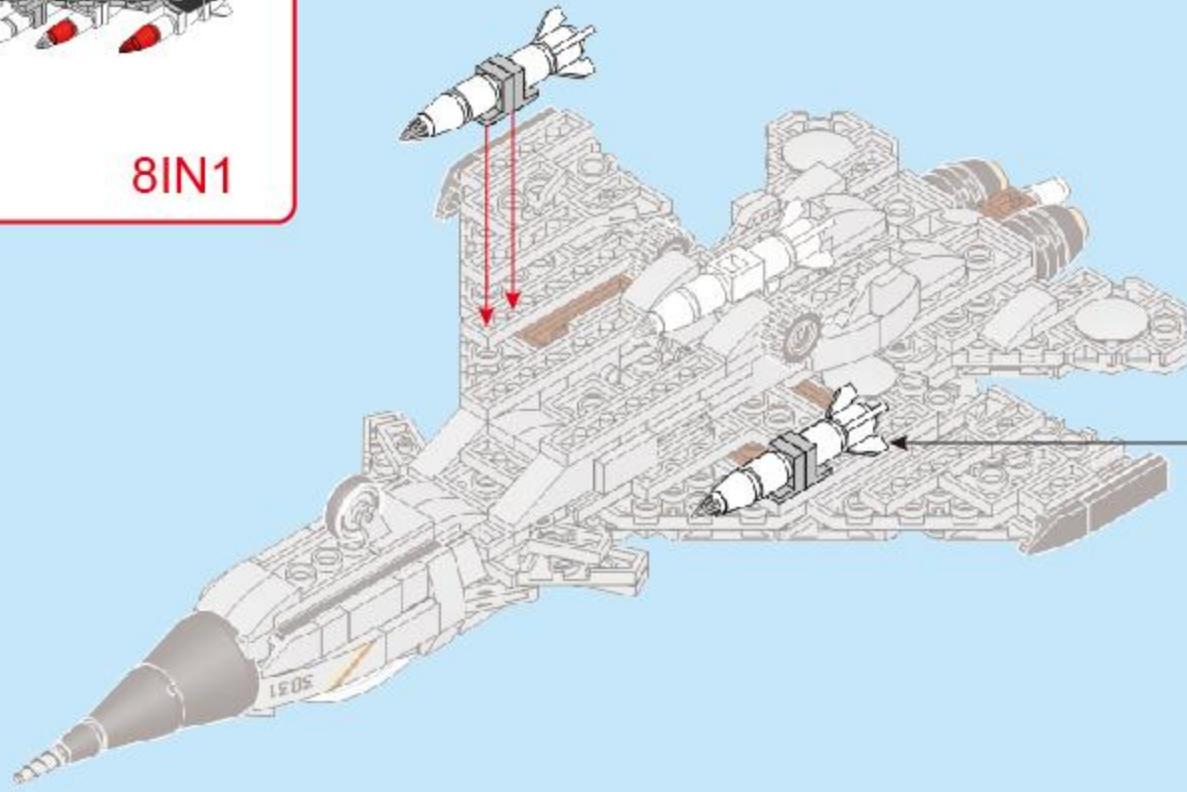

93

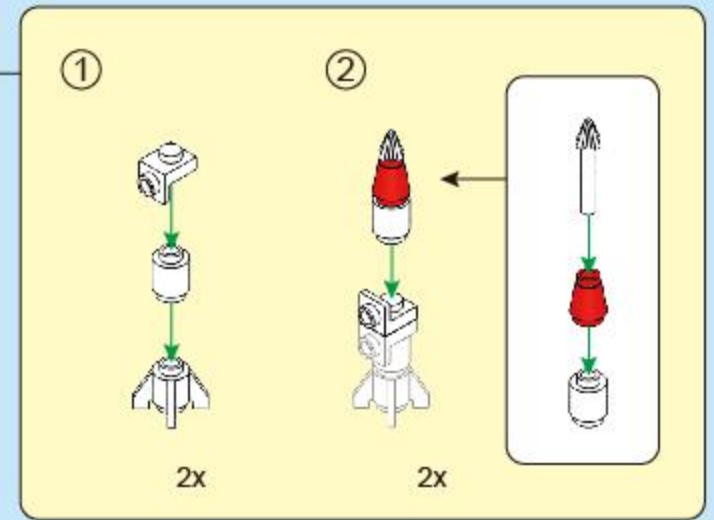
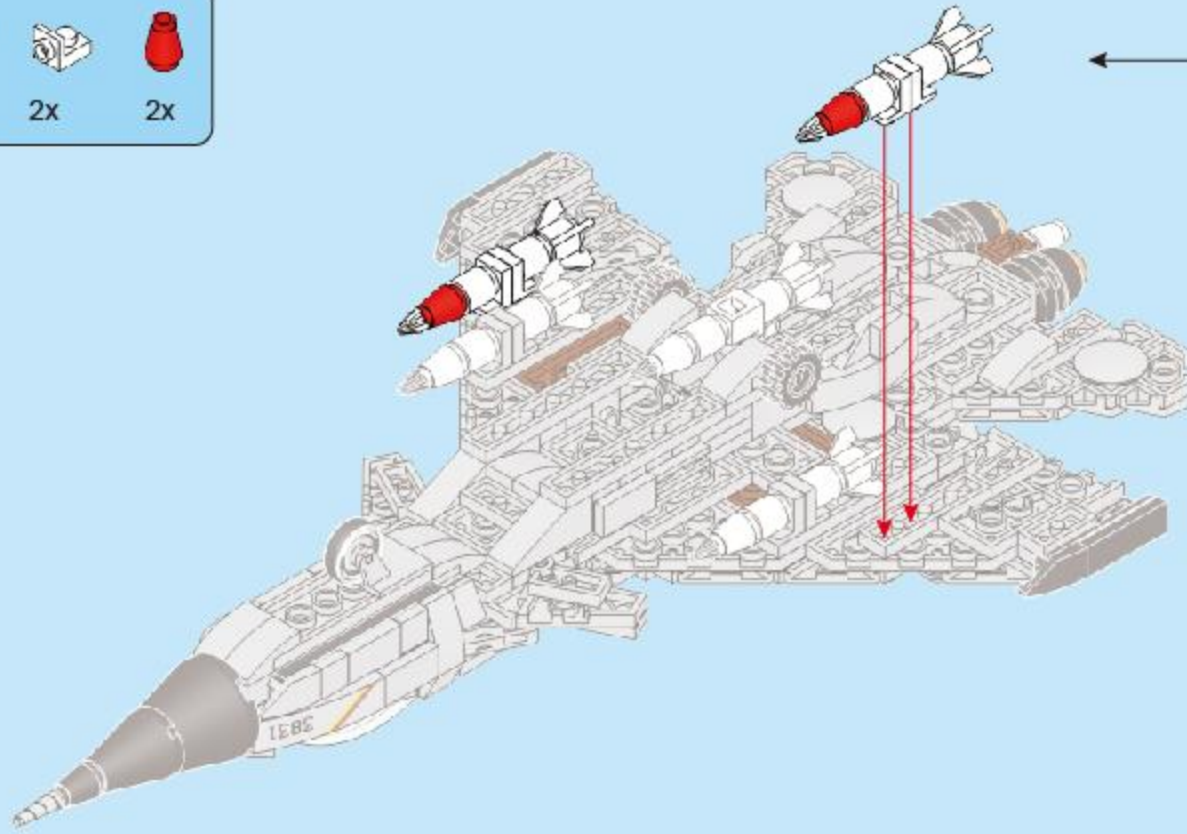

94

