

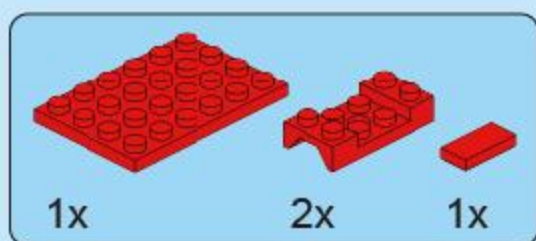

1.09.04.8138.01

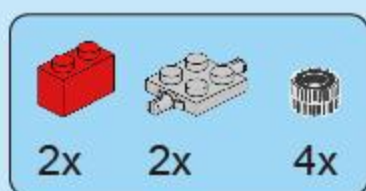

A1

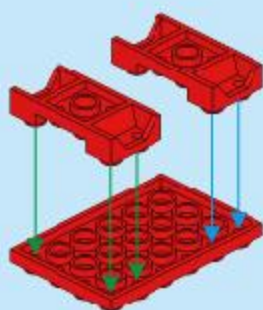
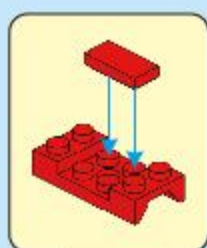

A2

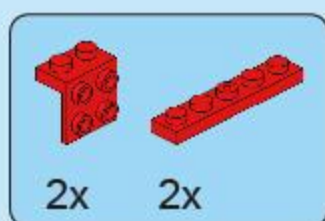
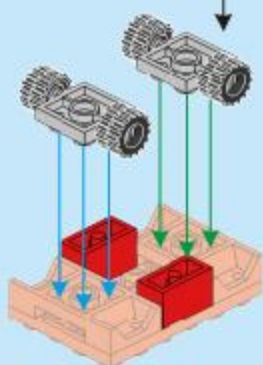
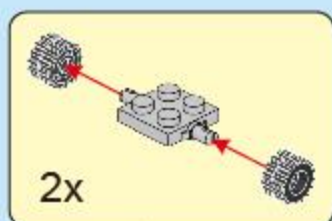

A3

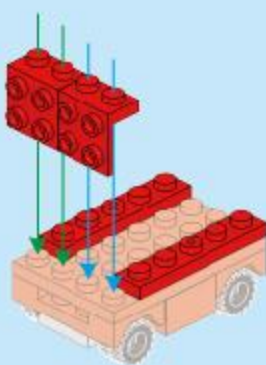

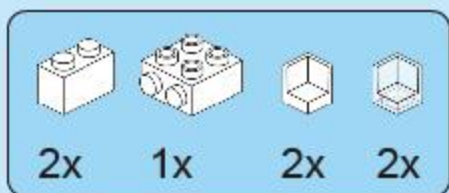

A4

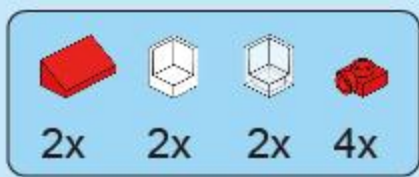
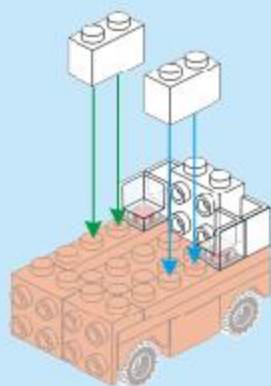

A5

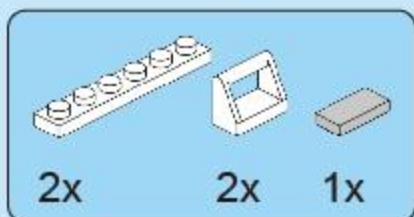
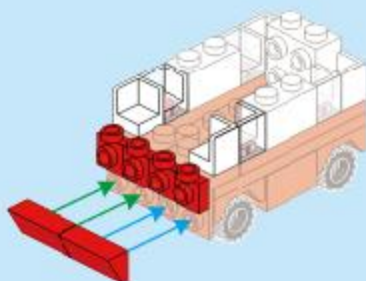

A6

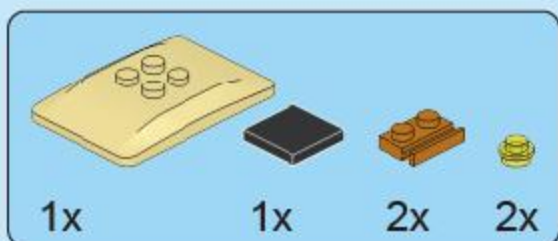
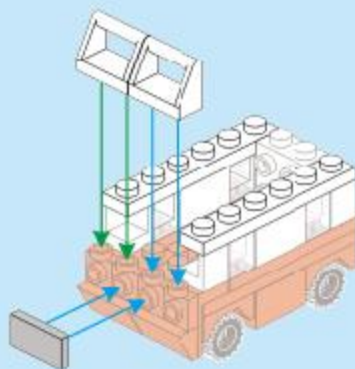

A7

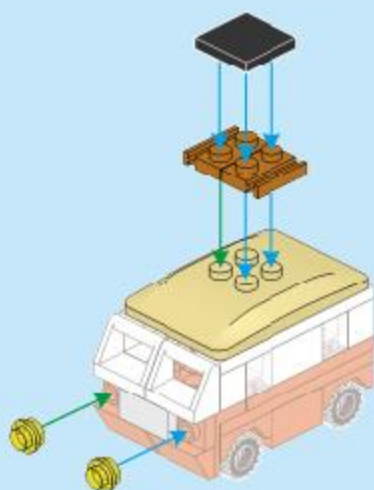

A

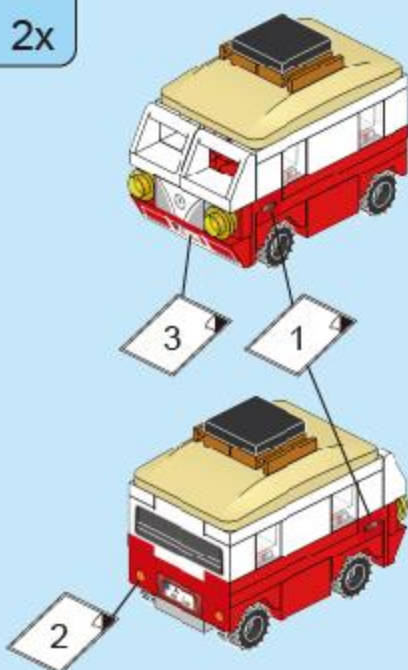



1.09.04.8138.02

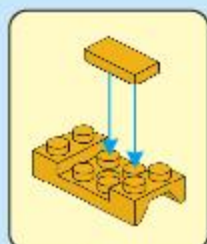
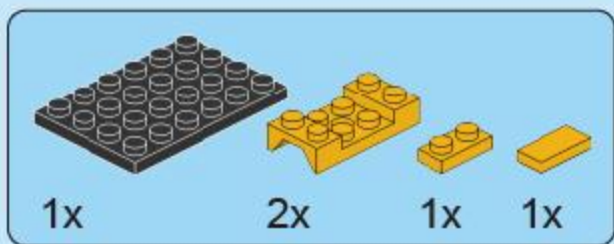

B1

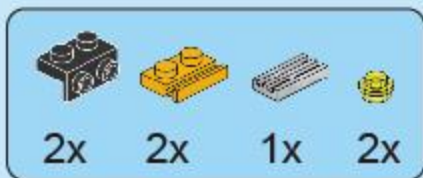
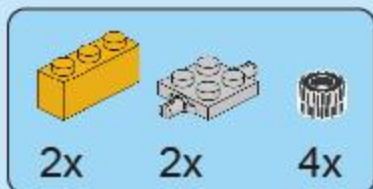
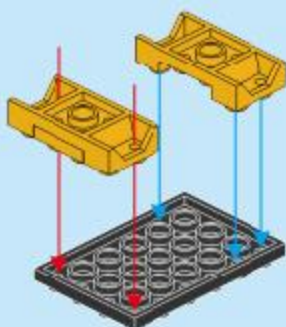
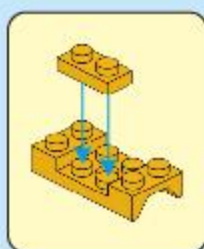

B2

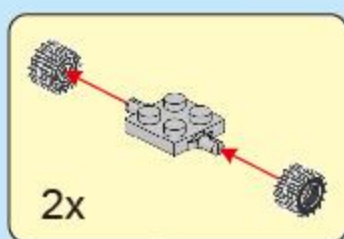

B3

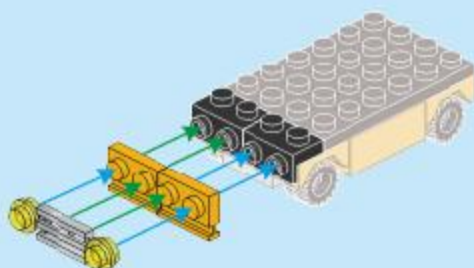
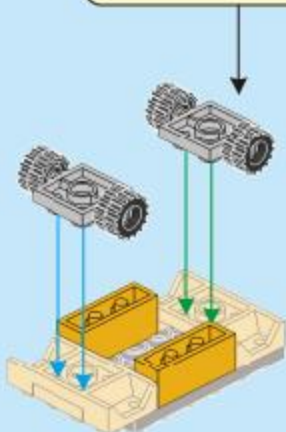



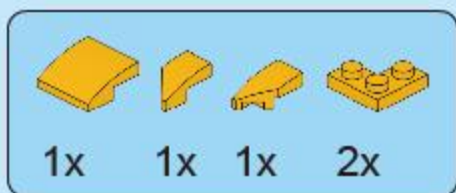

B4

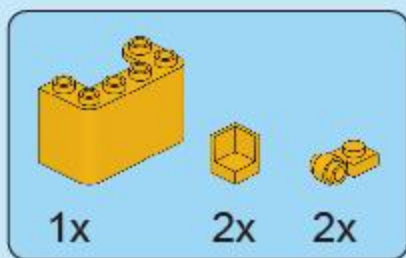
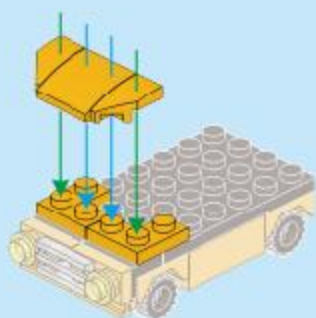

B5

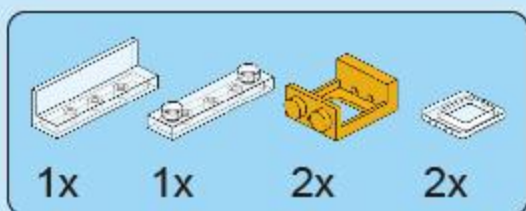
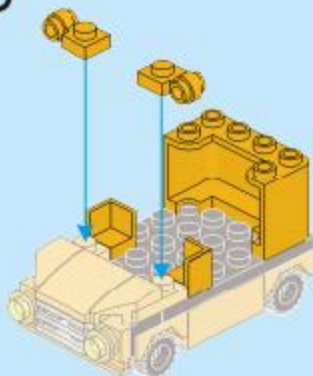

B6

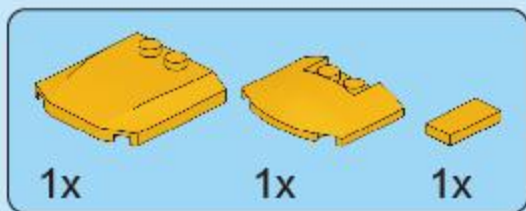
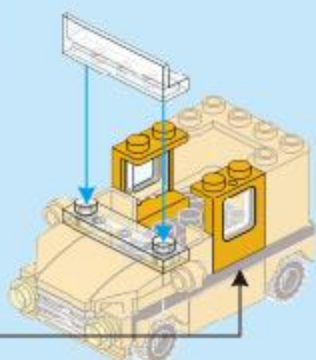
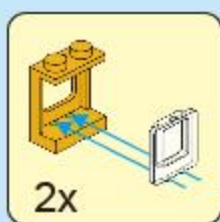

B7

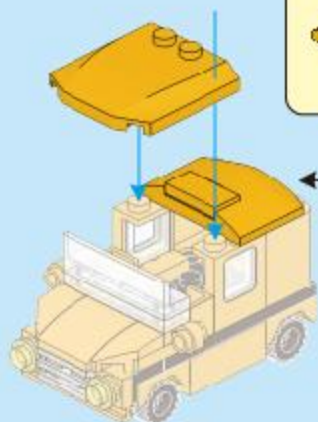
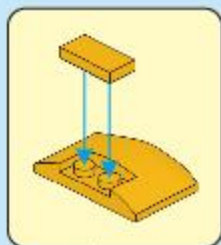

B

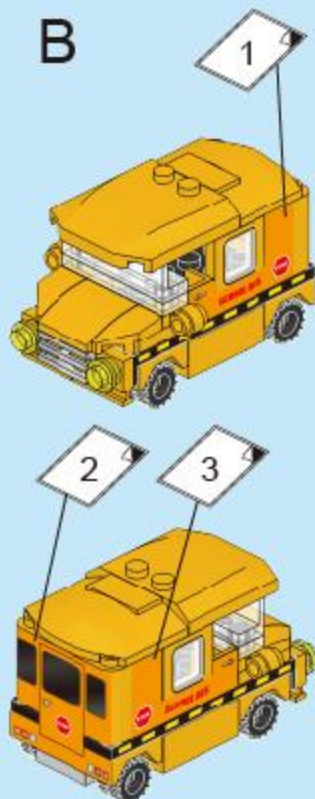



1.09.04.8138.03



1x

1x

1x

2x

C1

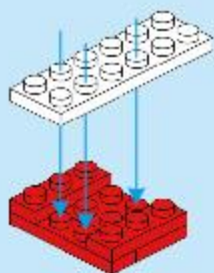
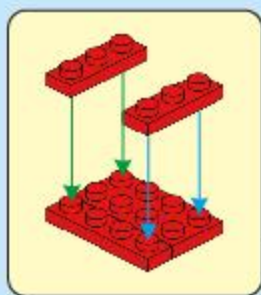

2x

2x

4x

C2

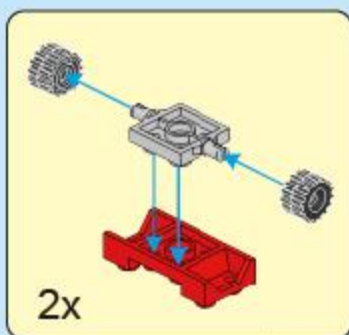

2x

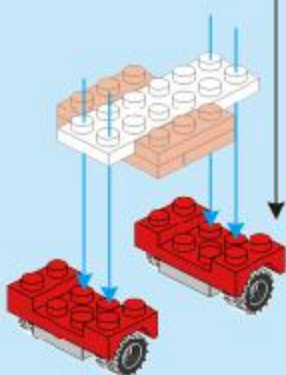

2x

2x

1x

C3

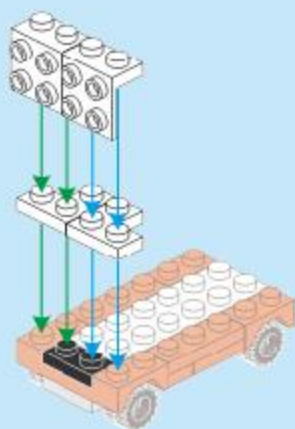

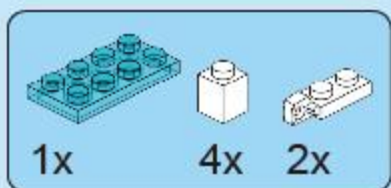
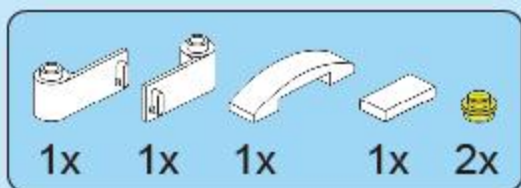

C4

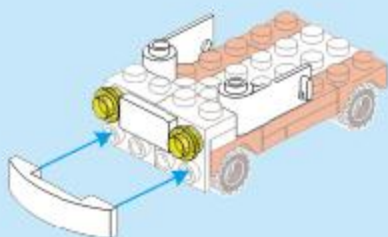

C5

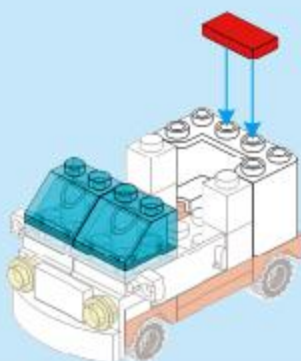
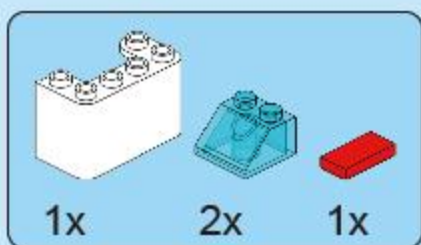
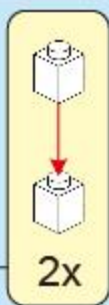
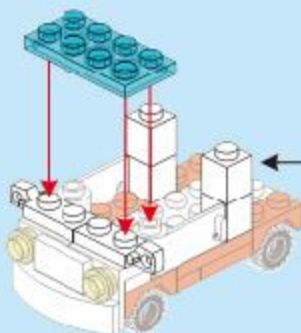

C6

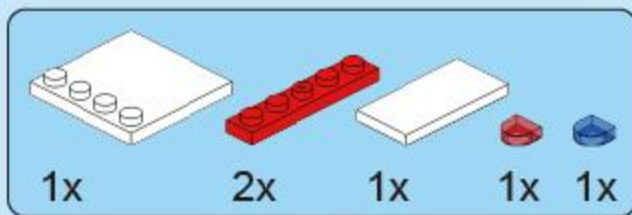

C7

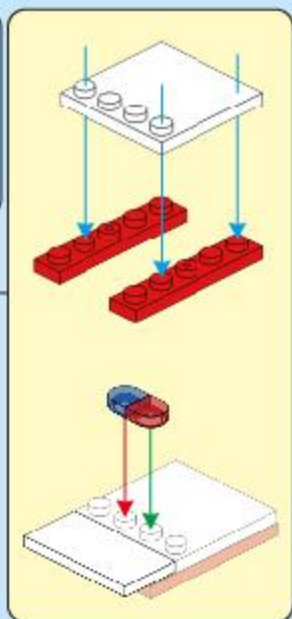
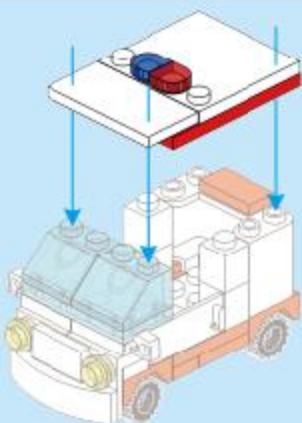

C

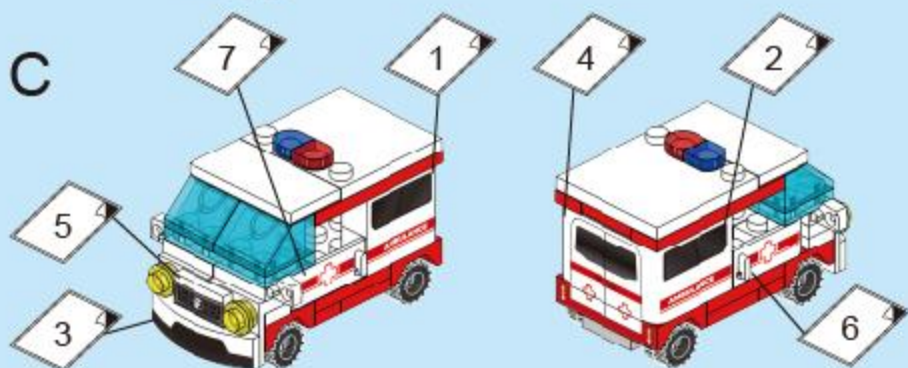





1.09.04.8138.04

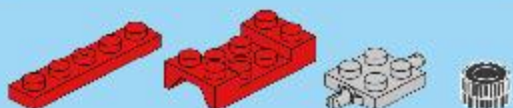

2x

2x

2x

4x

D1

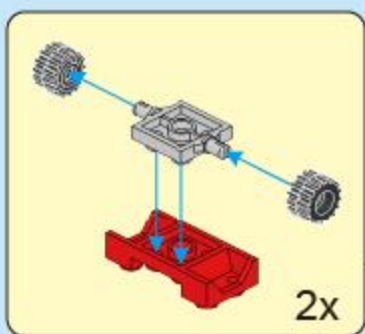

2x

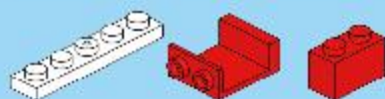
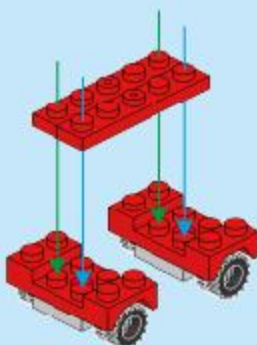

2x

1x

2x

D2



2x

2x

2x

D3

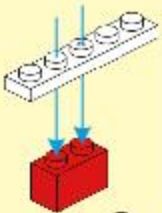

2x

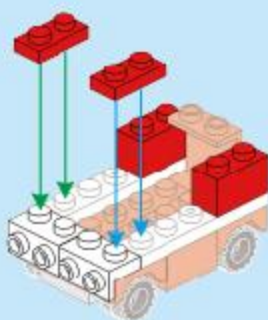
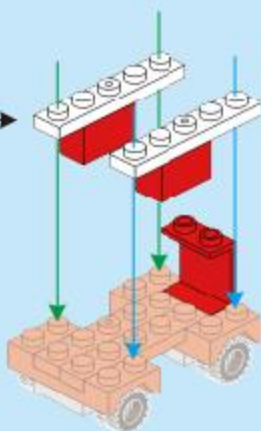

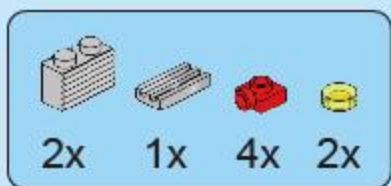

D4

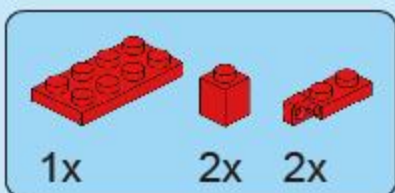
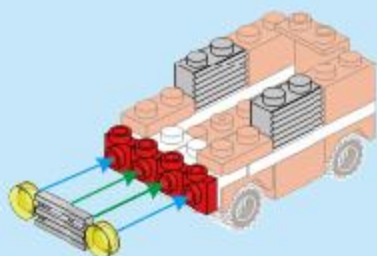

D5

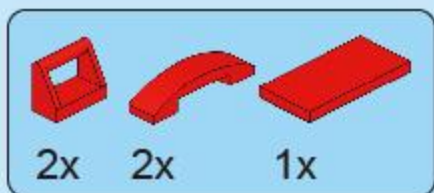
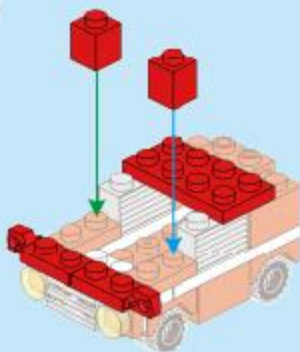

D6

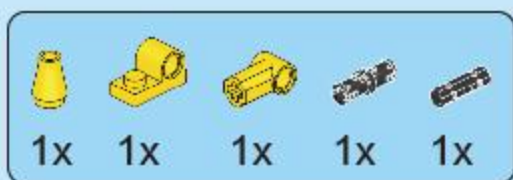
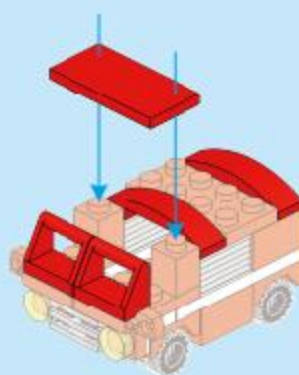

D7

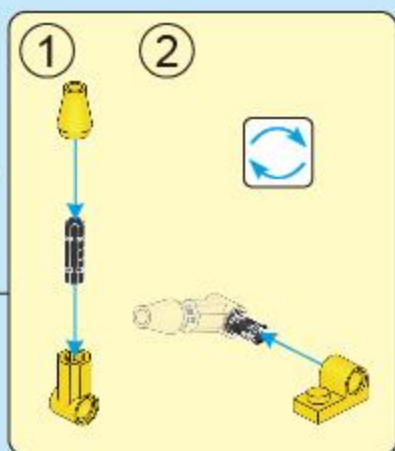
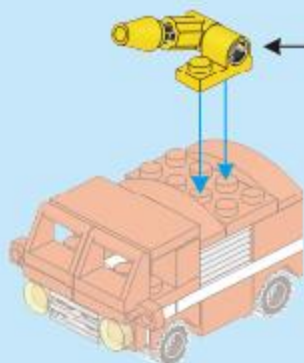

D





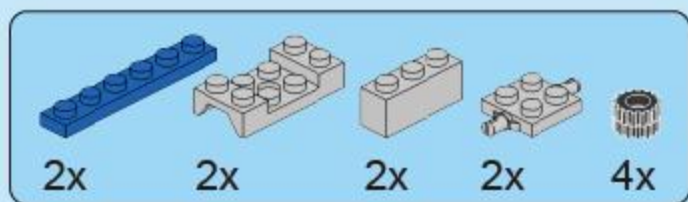

E1

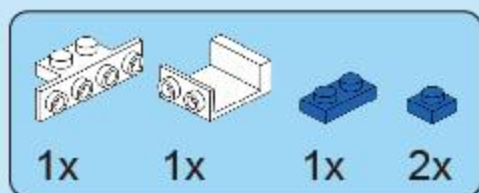
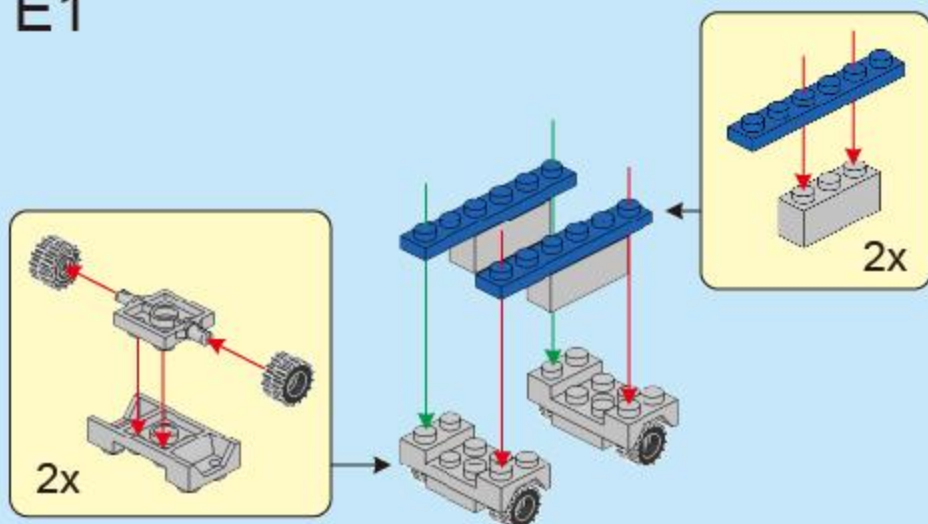

E2

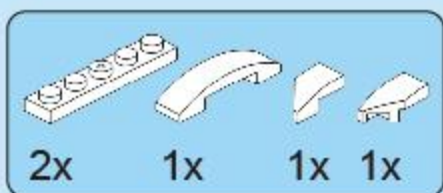
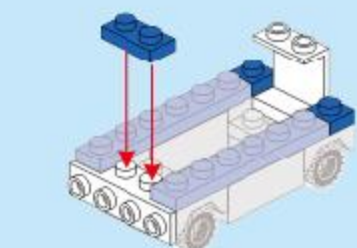

E3

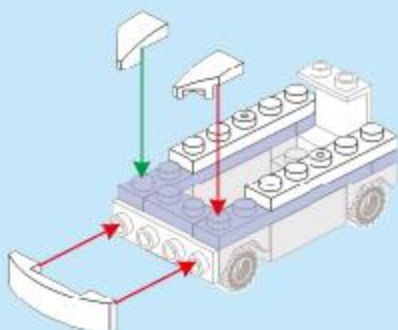

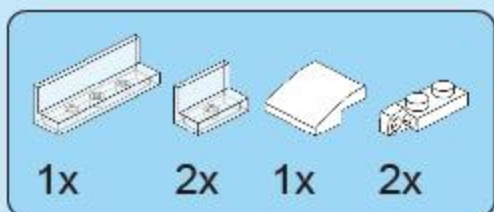

E4

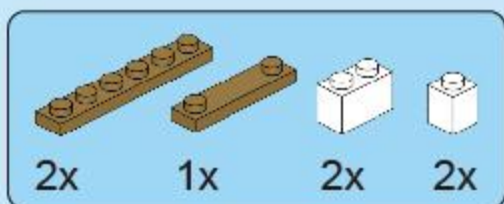
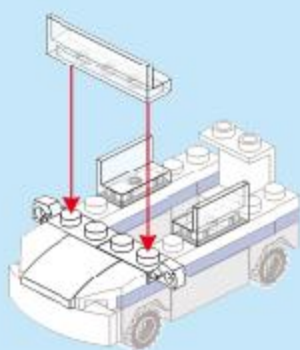

E5

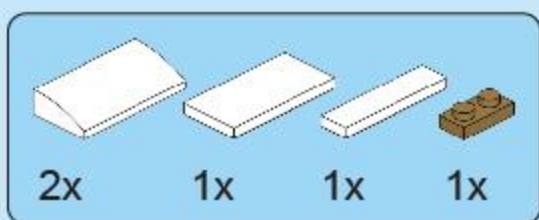
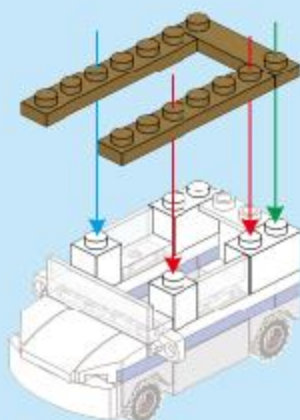

E6

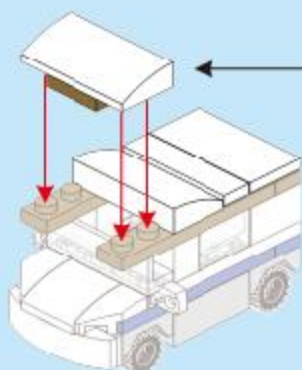
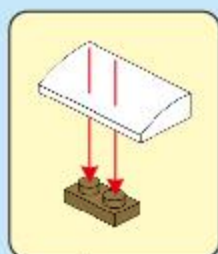

E

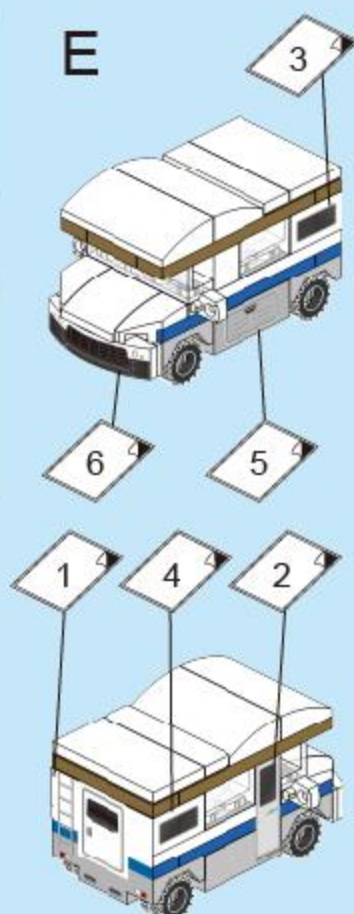

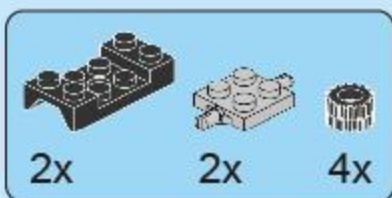

F1

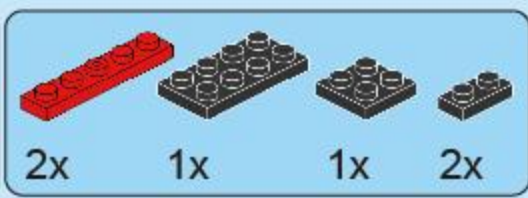
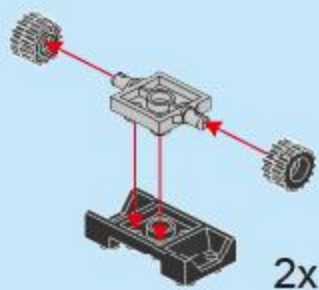

F2

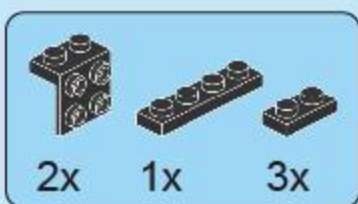
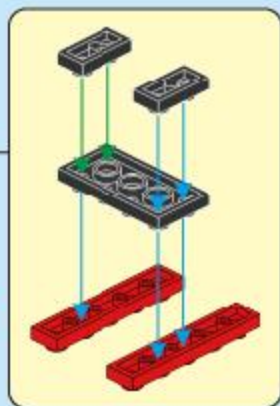
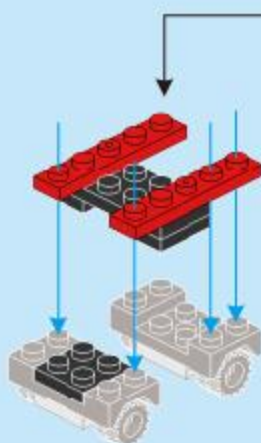

F3

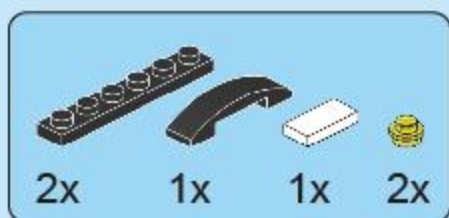
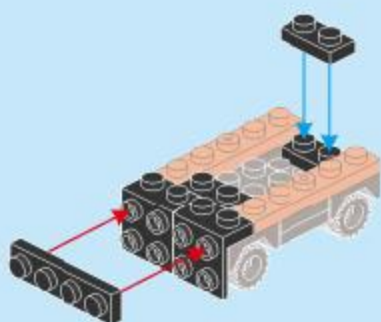

F4

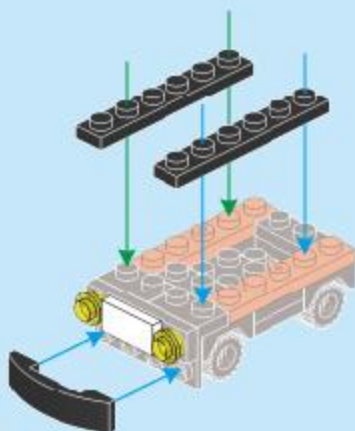



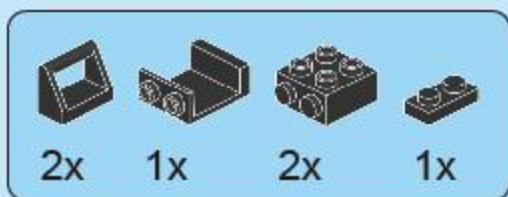

F5

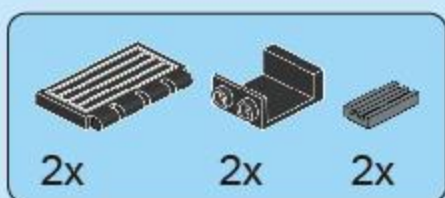
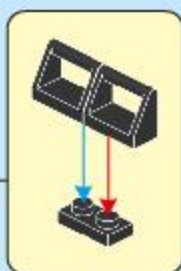
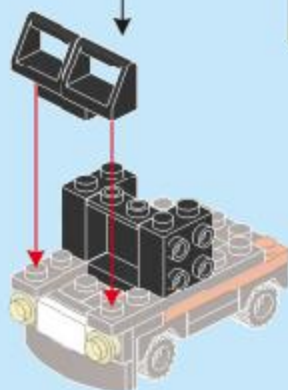

F6

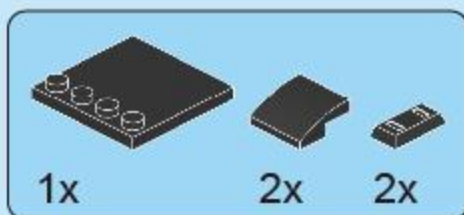
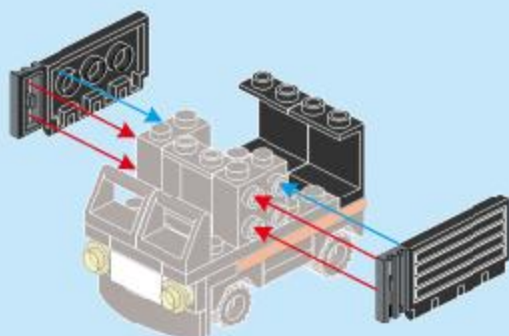

F7

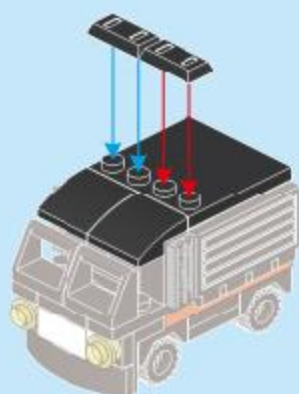

F

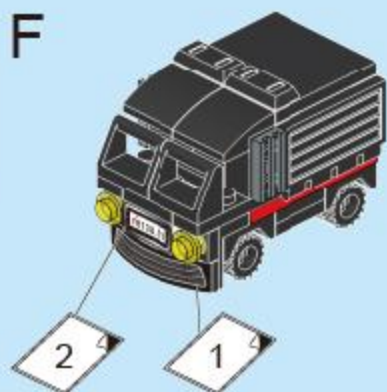



1.09.04.8138.07

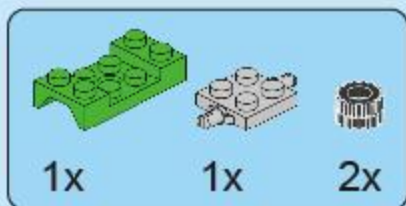

G1

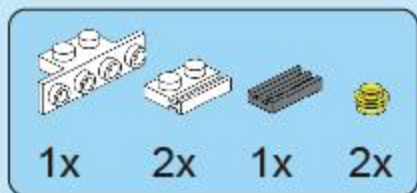
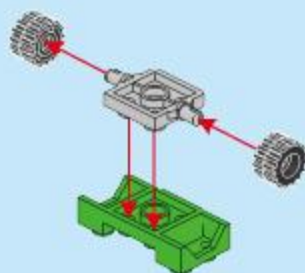

G2

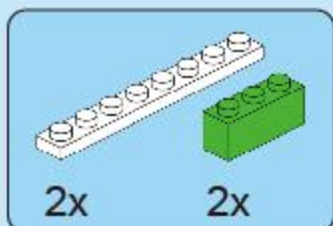
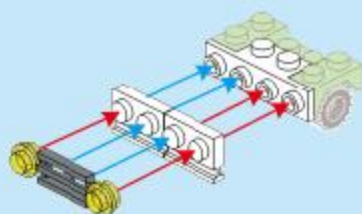

G3

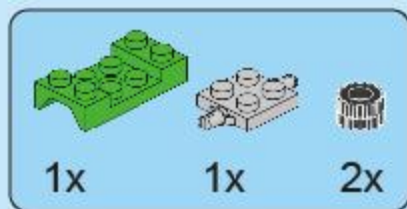
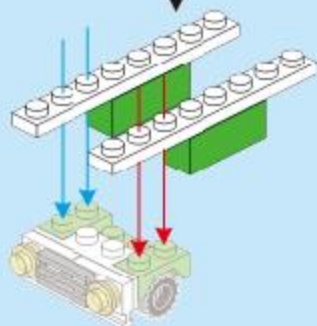
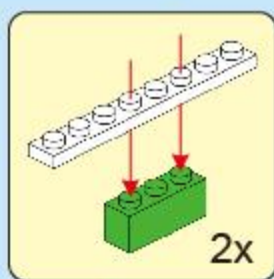

G4

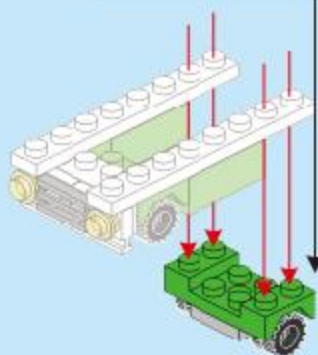
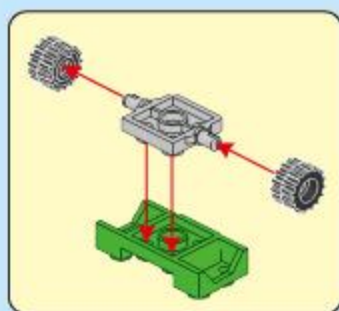

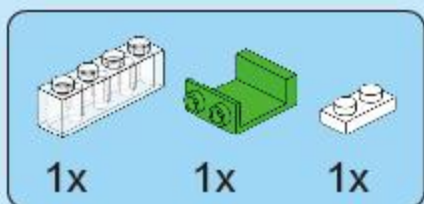

G5

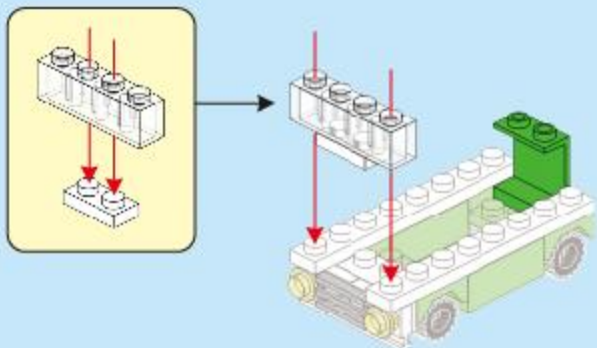

G6

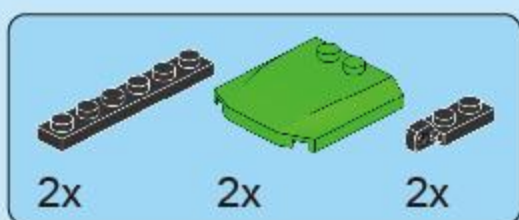

G7

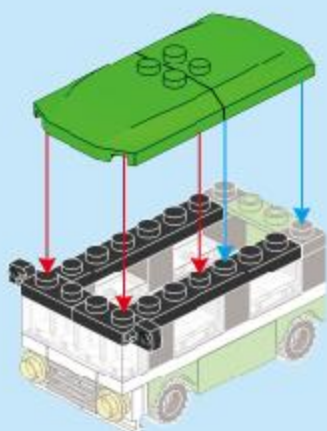
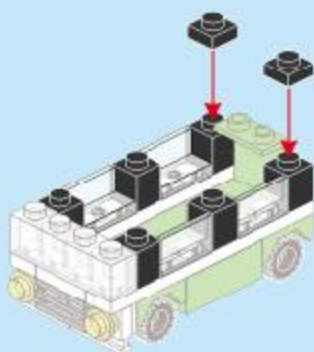

G

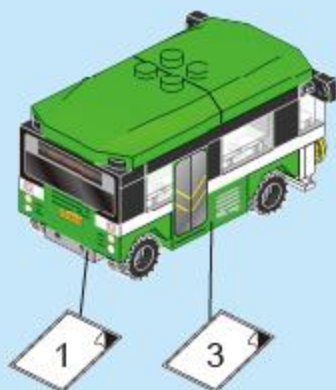



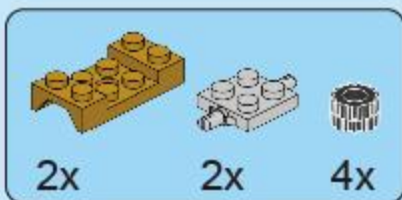

H1

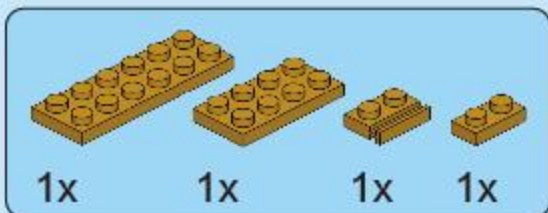
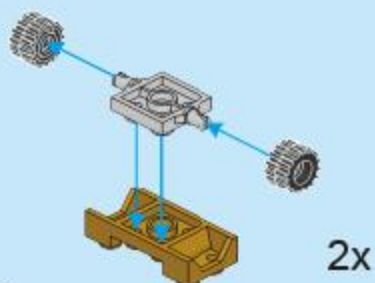

H2

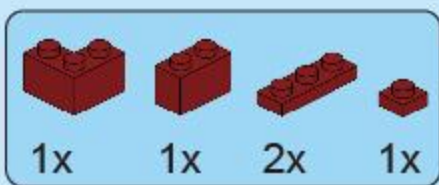
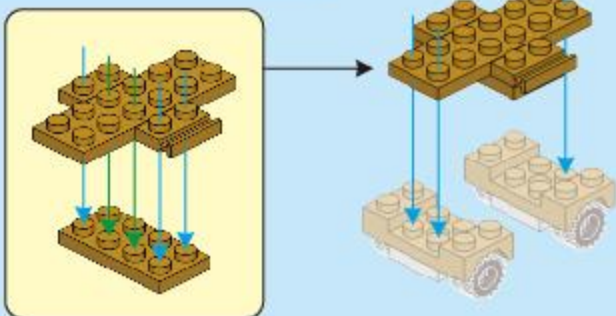

H3

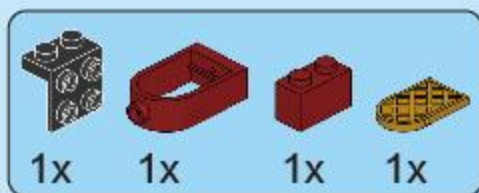
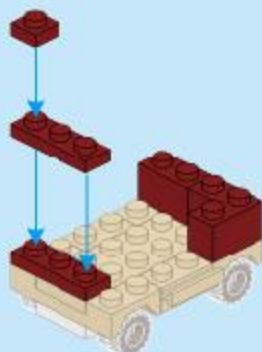

H4

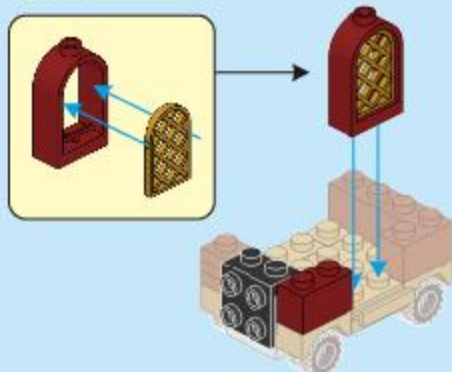

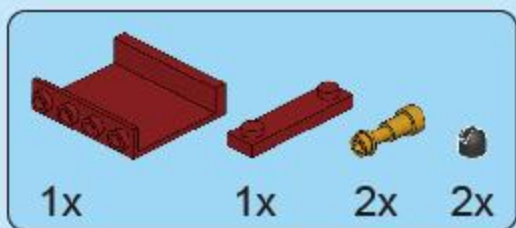

H5

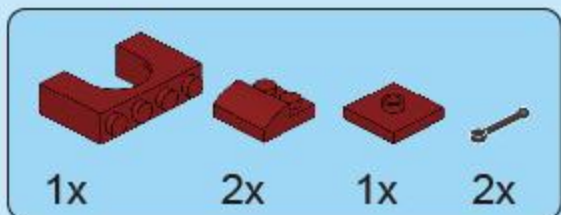
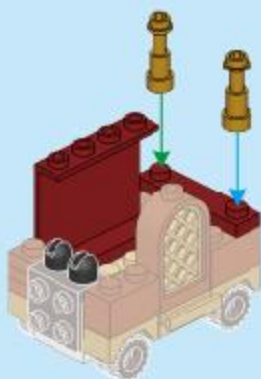

H6

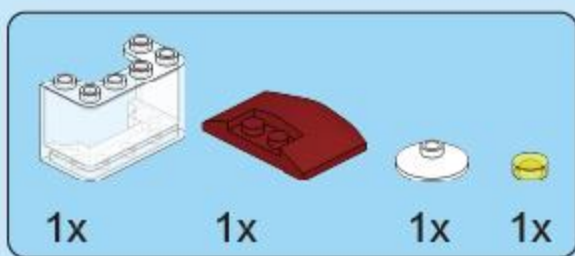
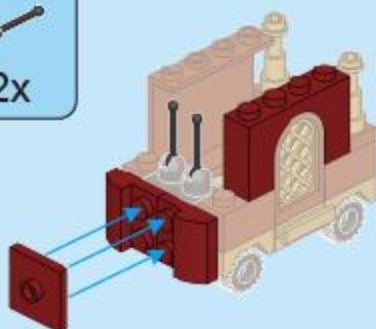

H7

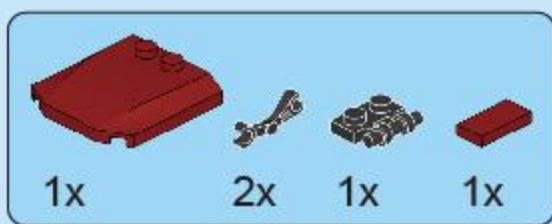
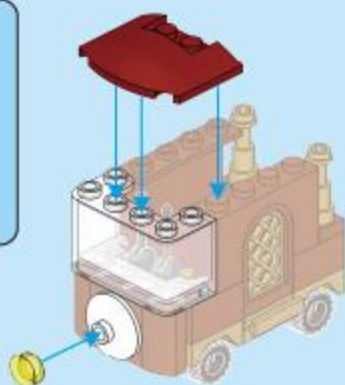

H8

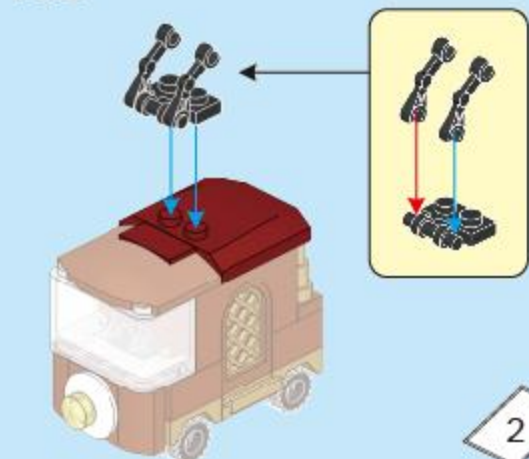

H

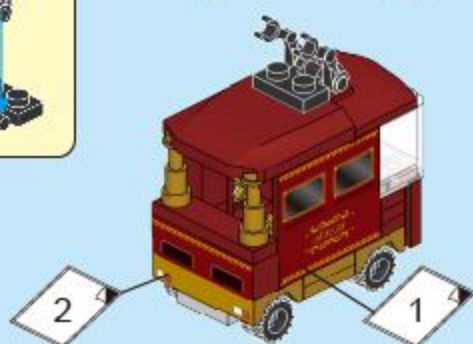
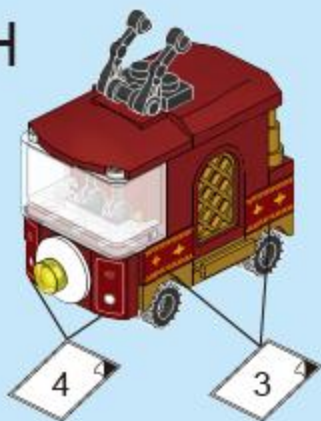



1.09.04.8138.09

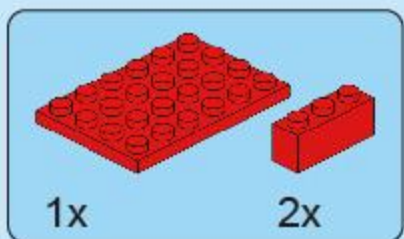

1x

2x

11

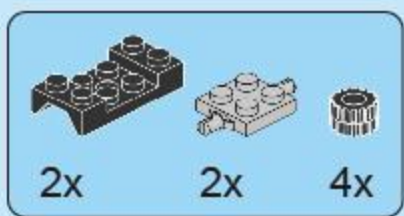
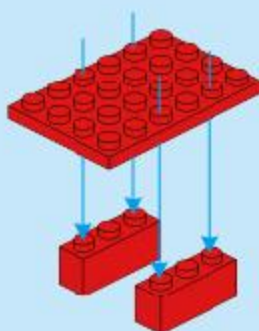

2x

2x

4x

12

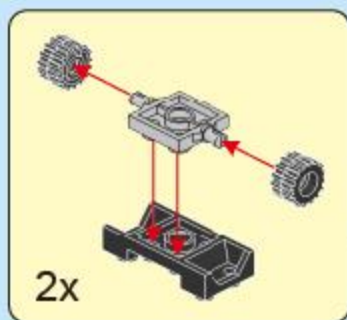

2x

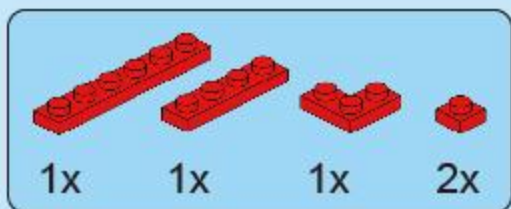
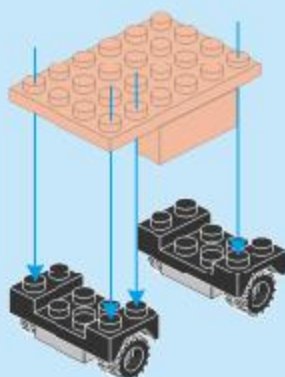

1x

1x

1x

2x

13

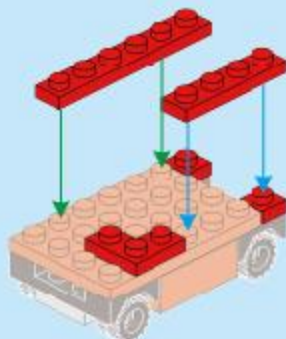



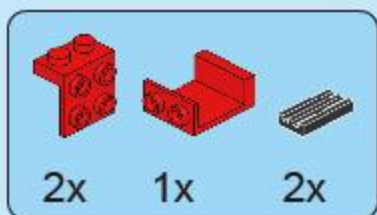

14

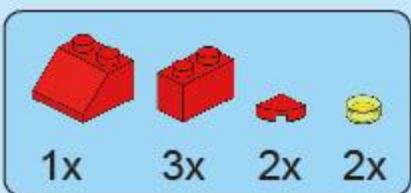
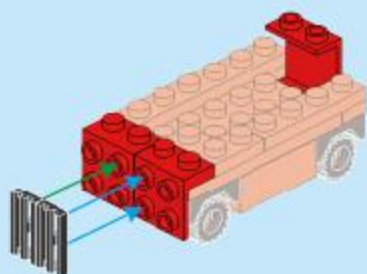

15

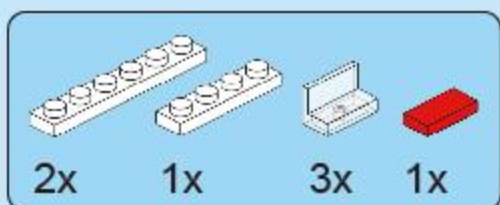
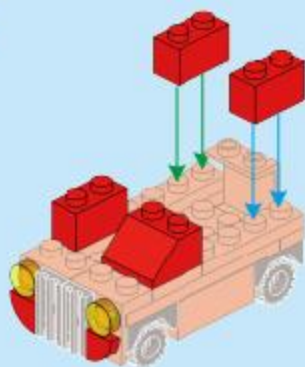

16

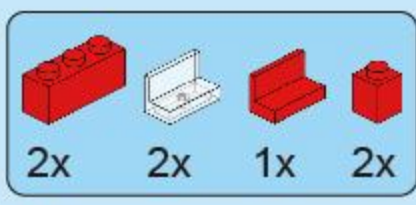
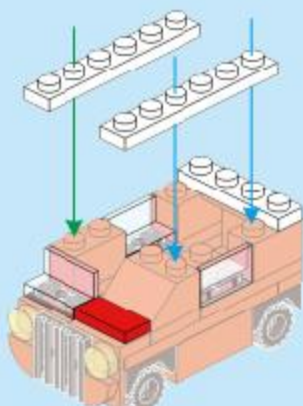

17

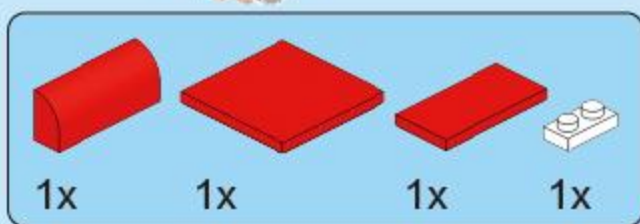
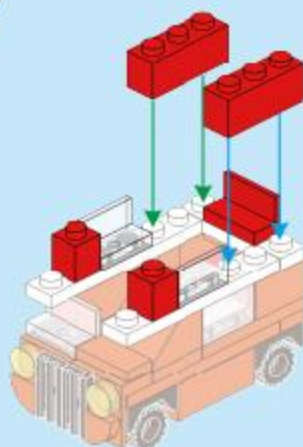

18

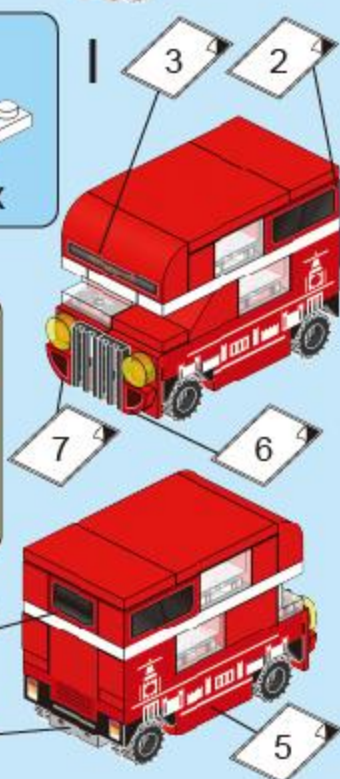
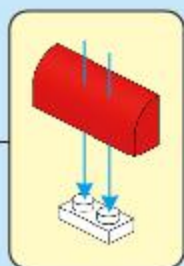
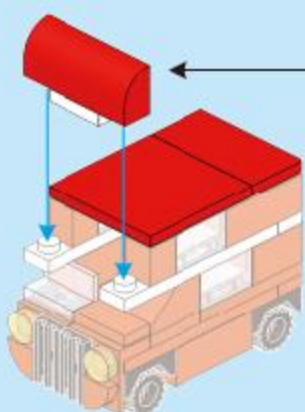

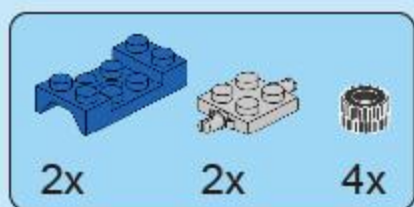

J1

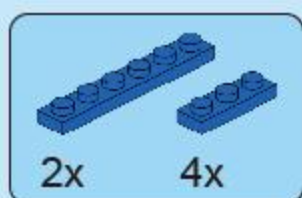
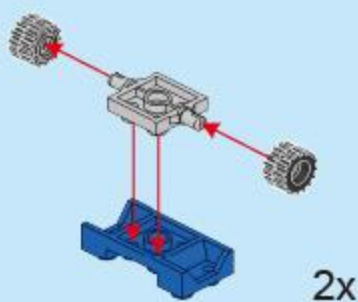

J2

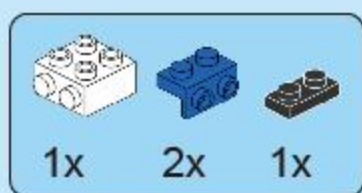
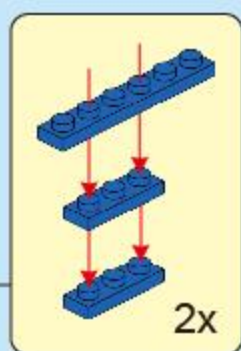
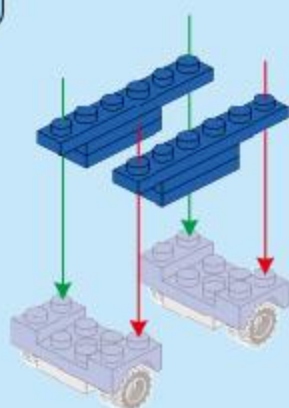

J3

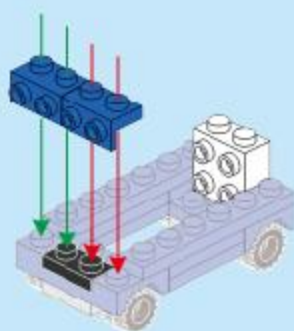

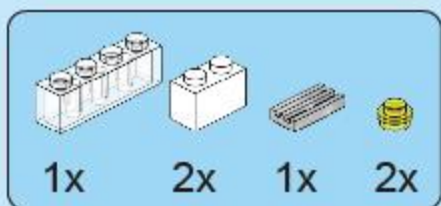

J4

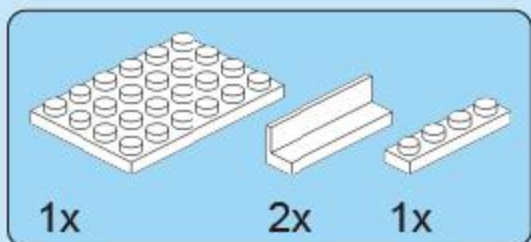
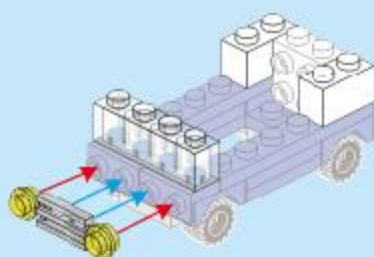

J5

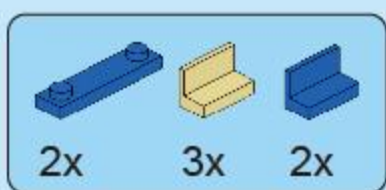
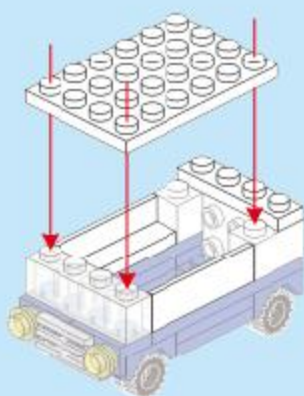

J6

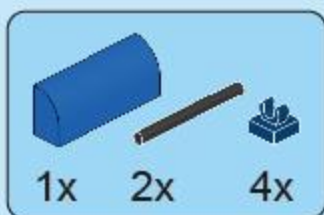
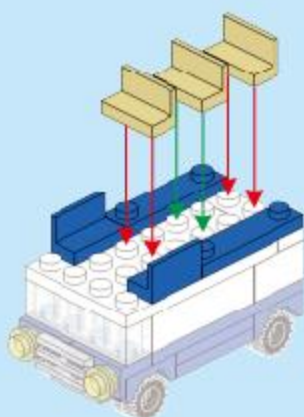

J7

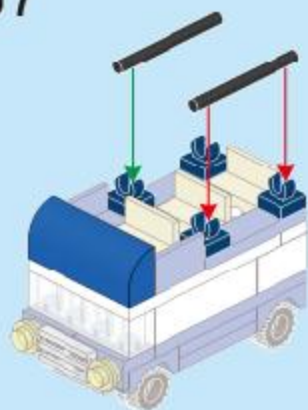

J

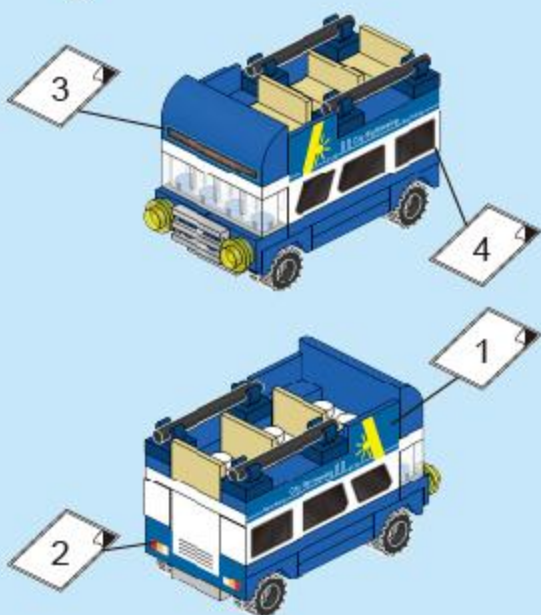





1.09.04.8138.11

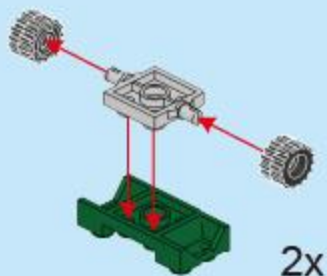
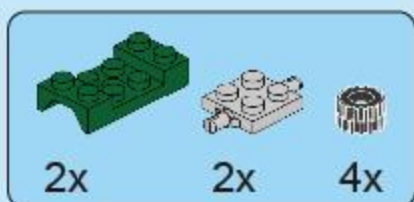

K1

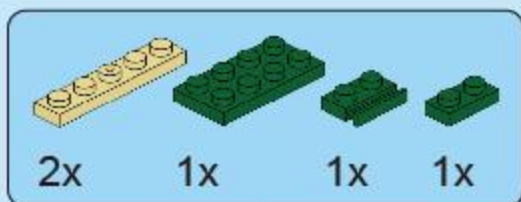

K2

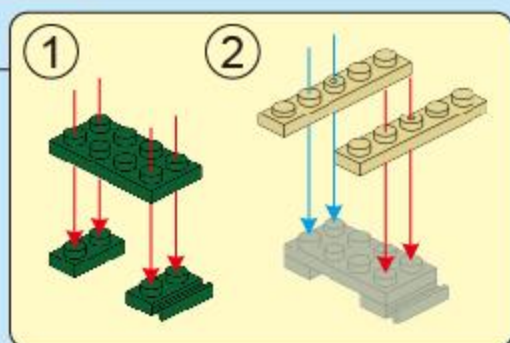
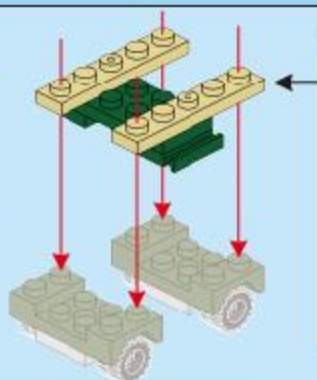

K3

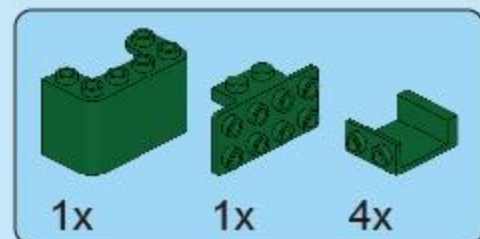
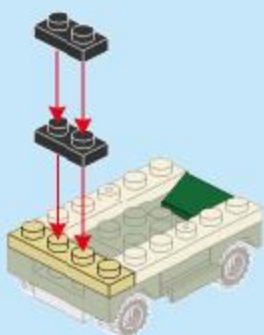

K4

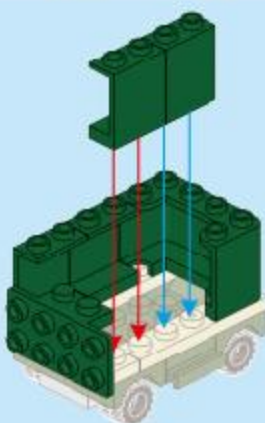

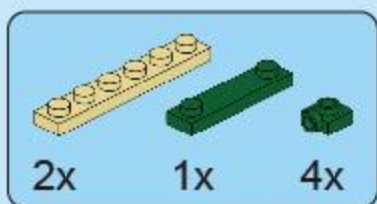

K5

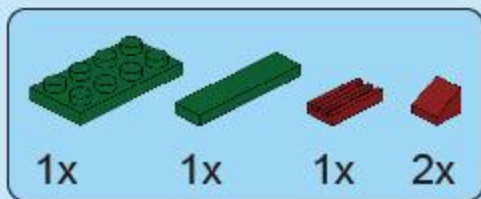
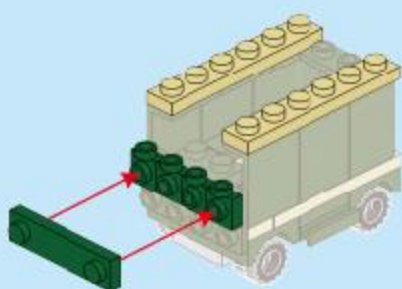

K6

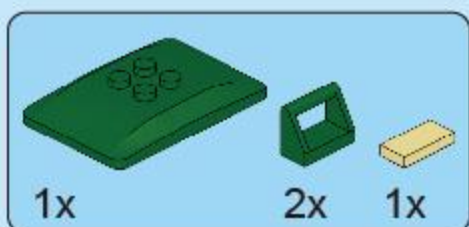
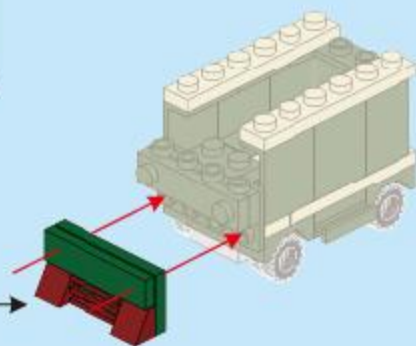
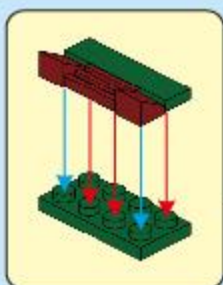

K7

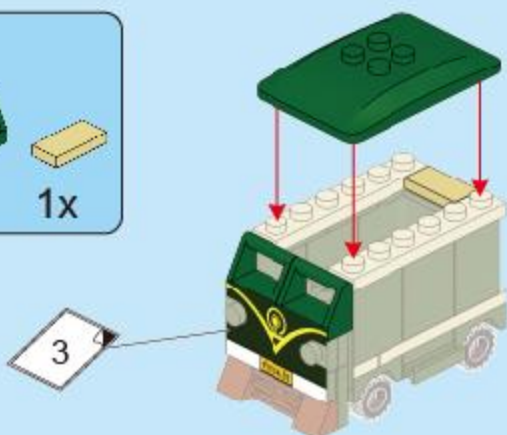

K8

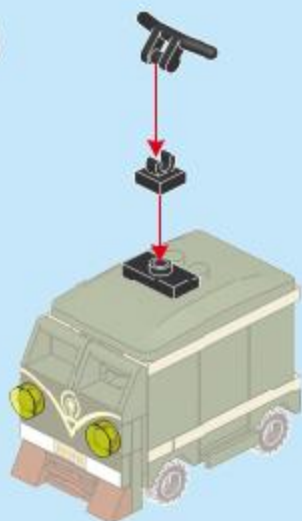

K

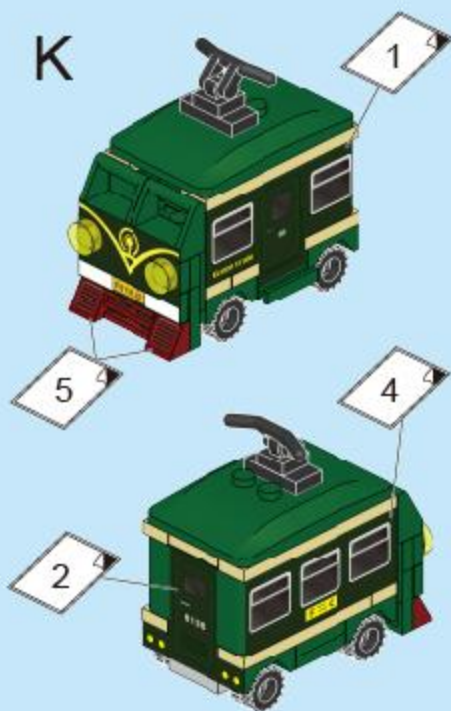



1.09.04.8138.12

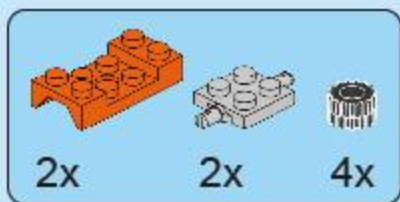

L1

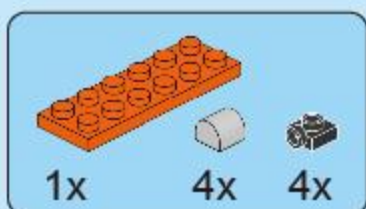
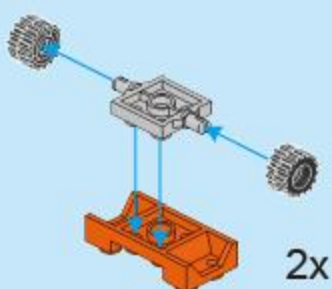

L2

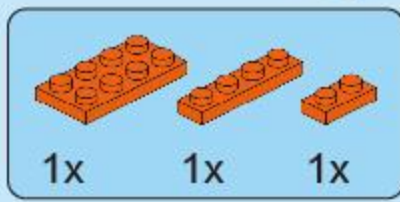
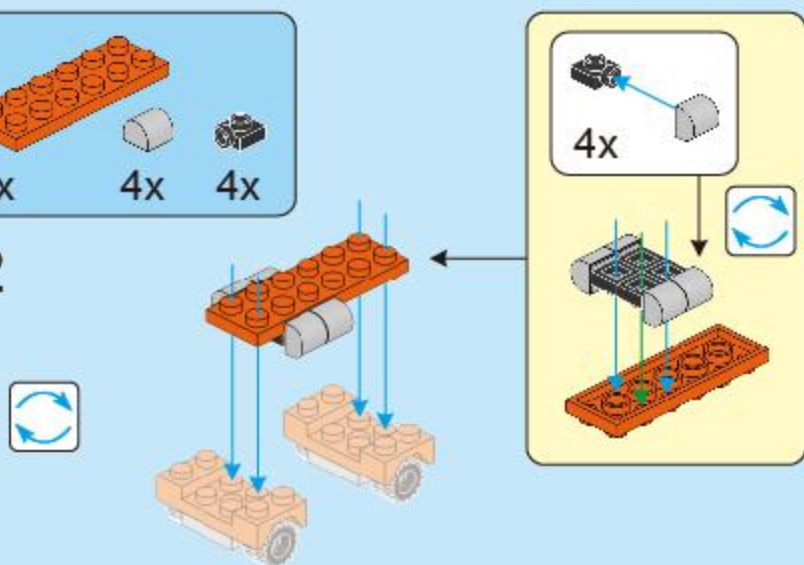

L3

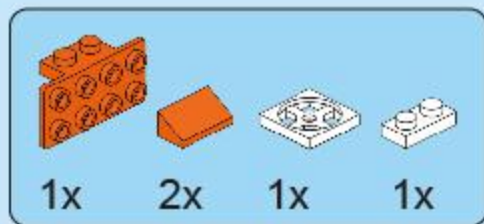
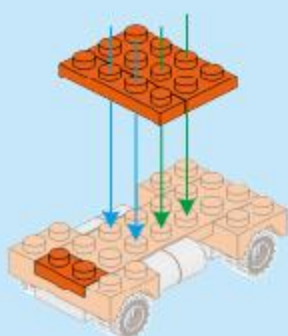

L4





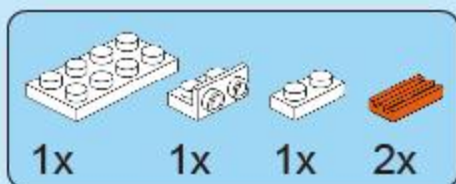

L5

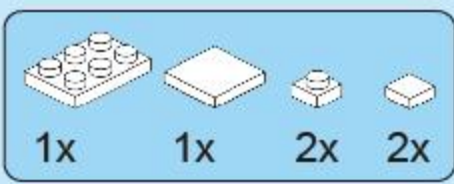
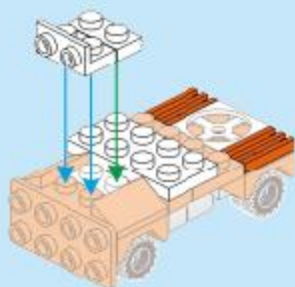

L6

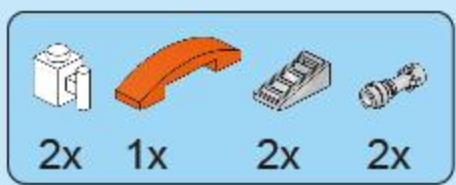
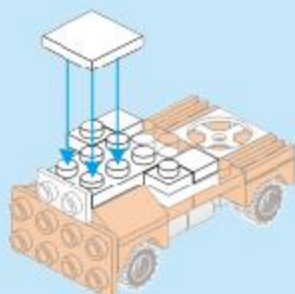

L7

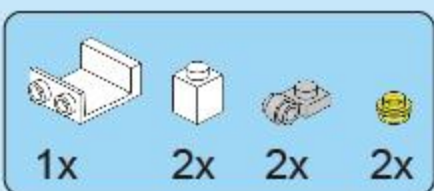
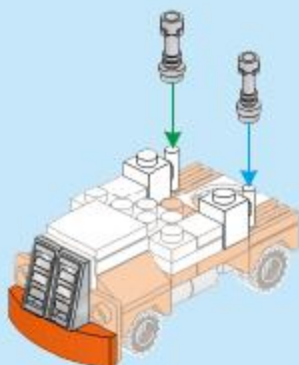

L8

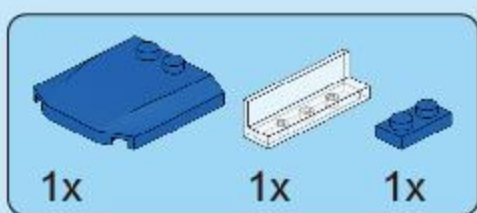
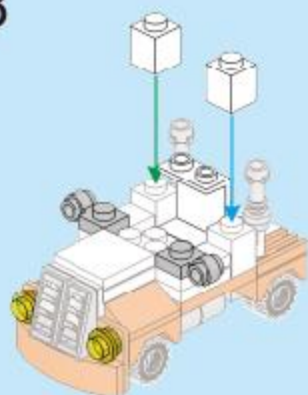

L9

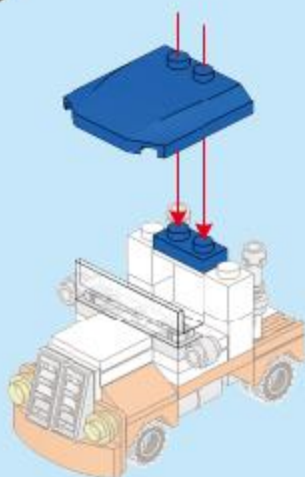

L

