

# ENGINE-MODEL



AEROBAT FORM

FC9301



拆件器使用方法, 仅为示例

Usage of Brick Separator, Just for the sample

1

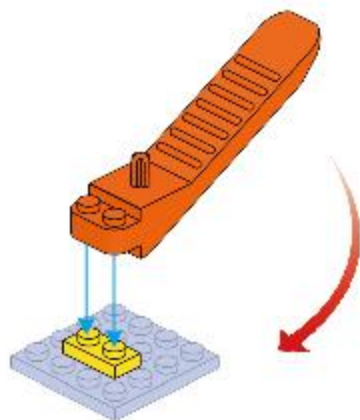

2

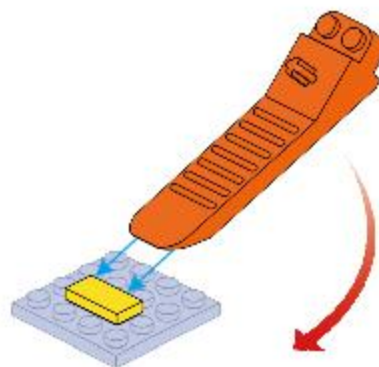

3

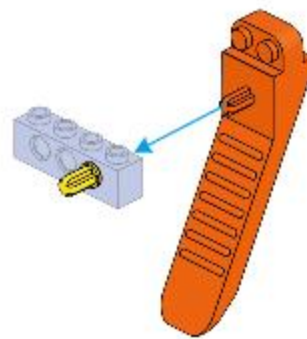

4

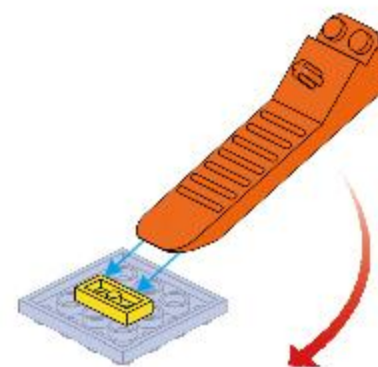

11



1x

2x

1

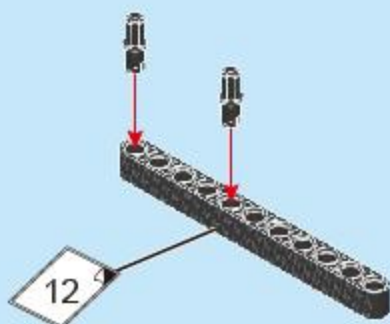

1x

1x

1x

2

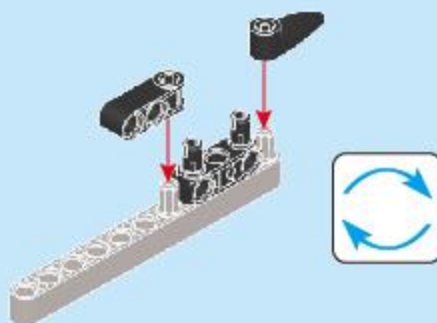

1x

1x

1x

3

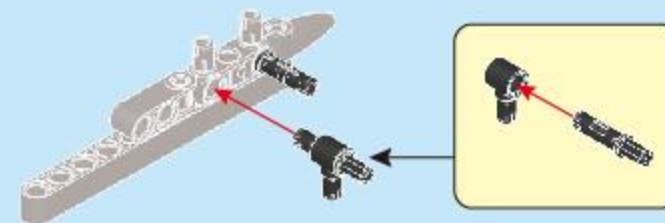

11



1x

2x

4

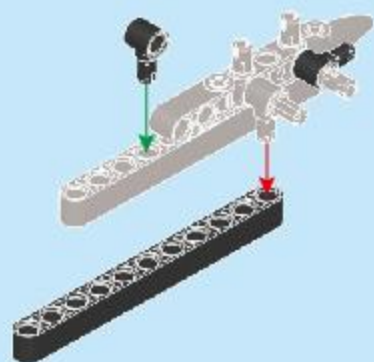

1x

1x

1x

5

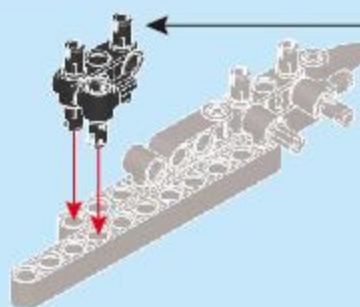

1

2



2



6

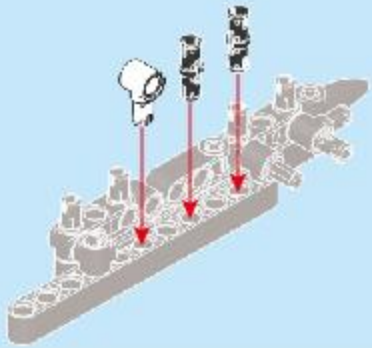

7

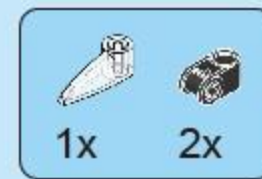
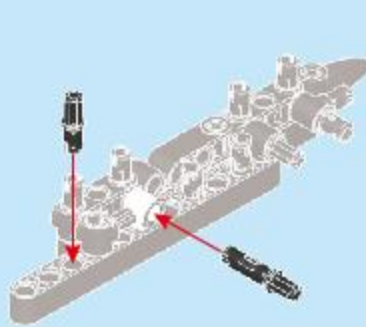

8

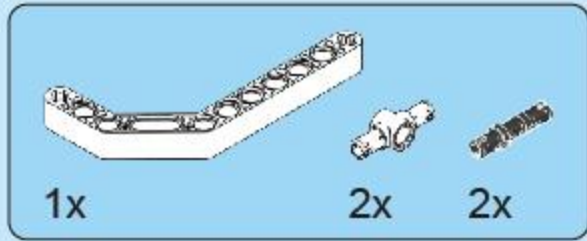
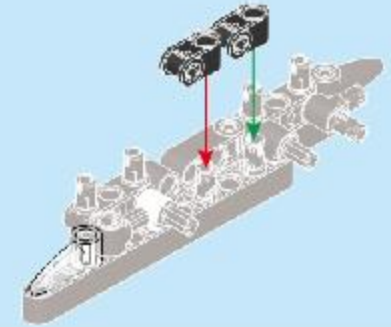

9

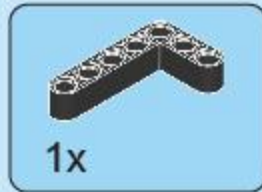
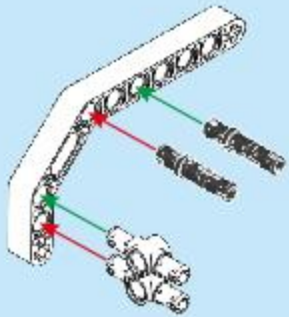

10

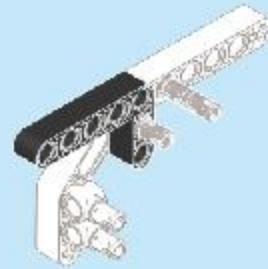

11

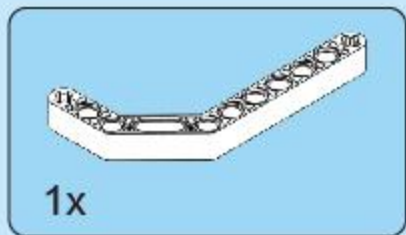
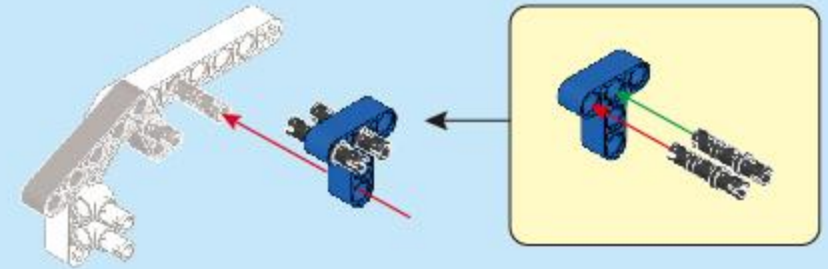

12

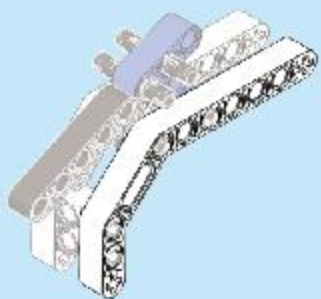

13

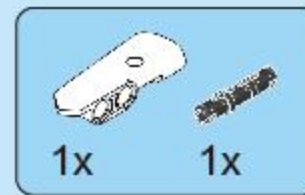
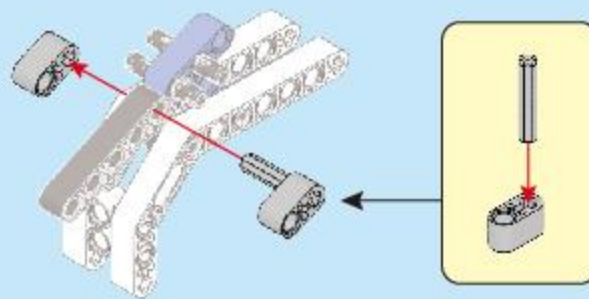

14

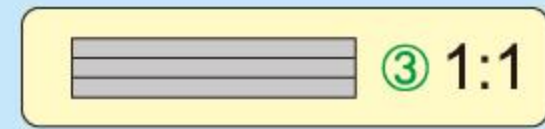
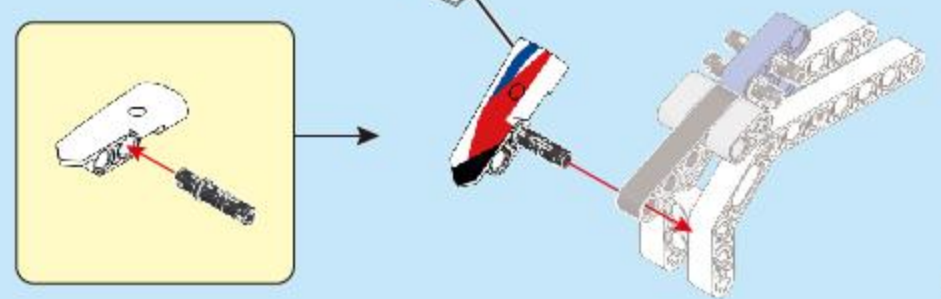

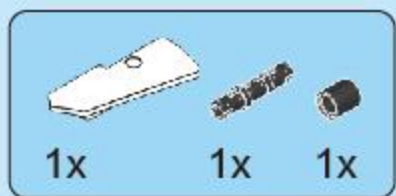

15

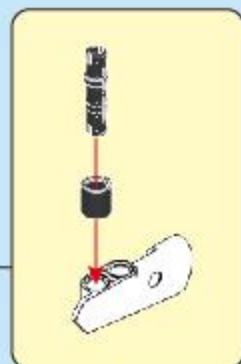
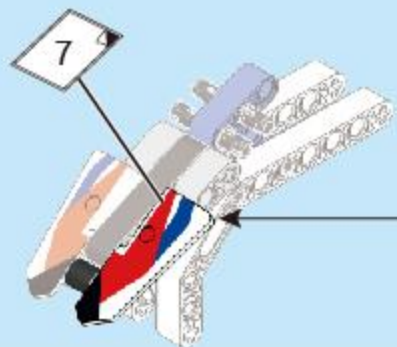

16

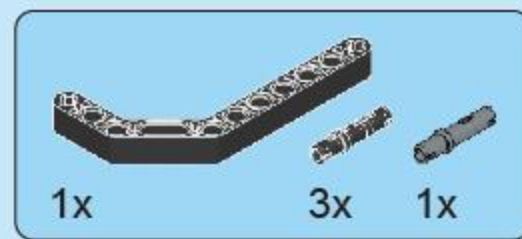
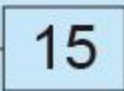
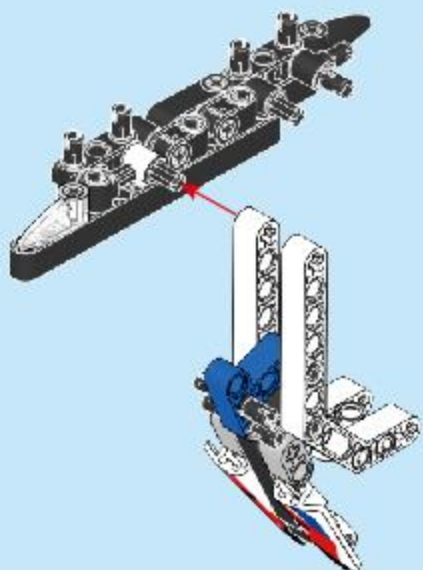

17

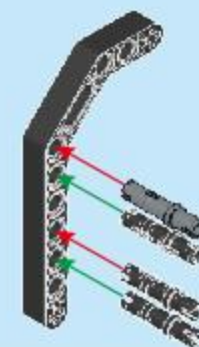

18

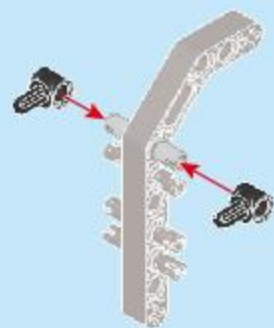

19

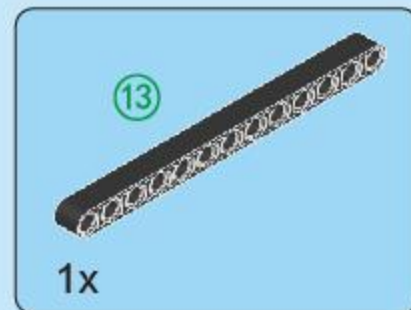
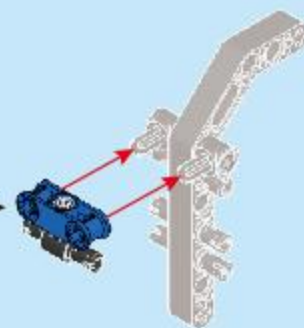
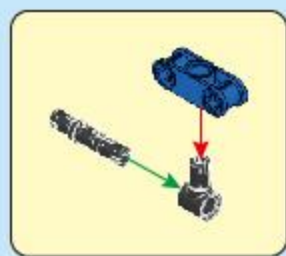

20

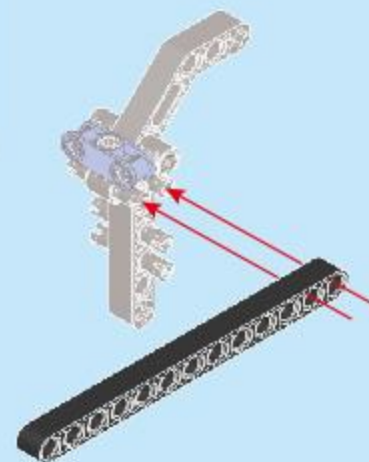

21

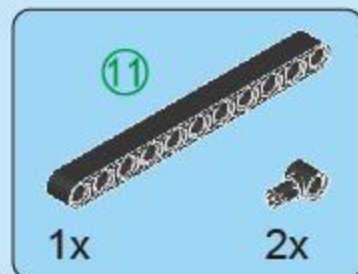
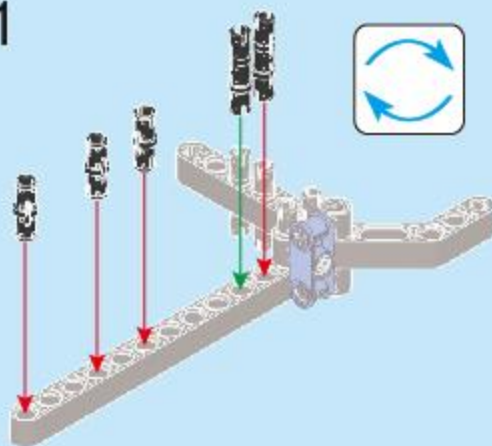

22

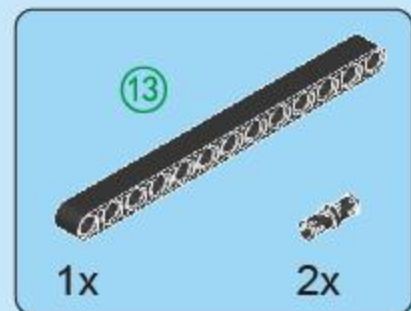
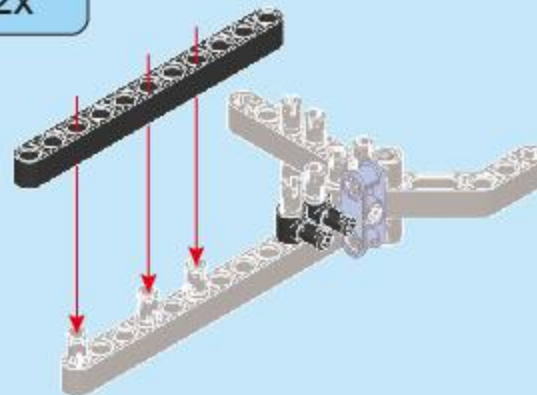

23

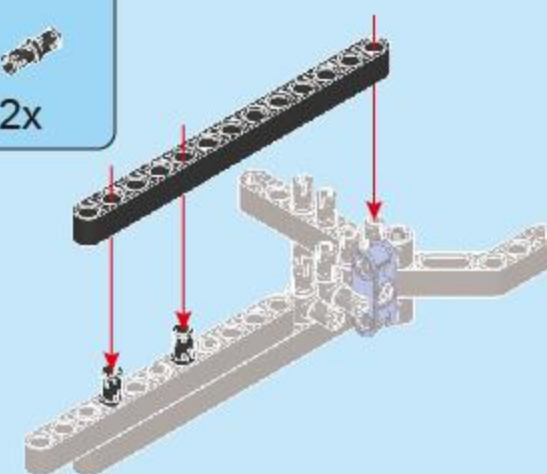



24

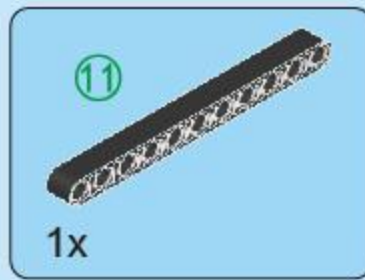
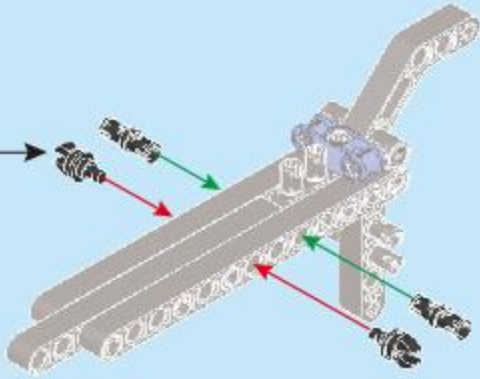

25

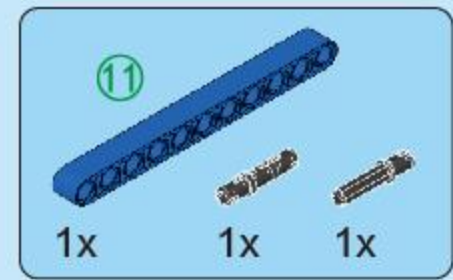

26

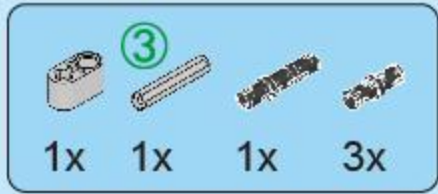
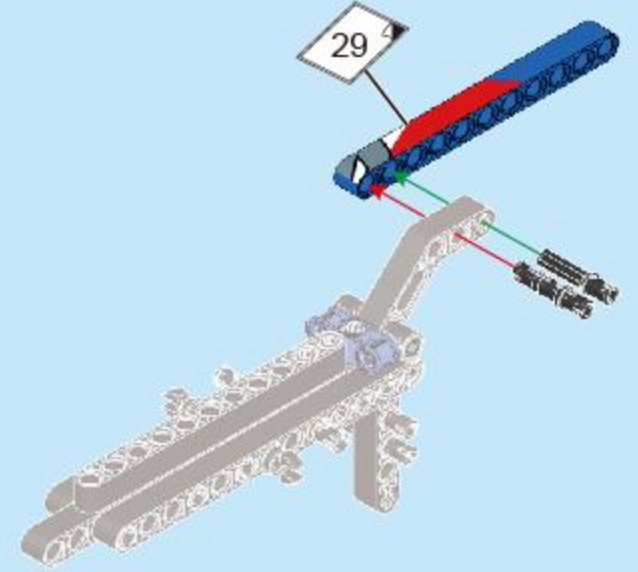
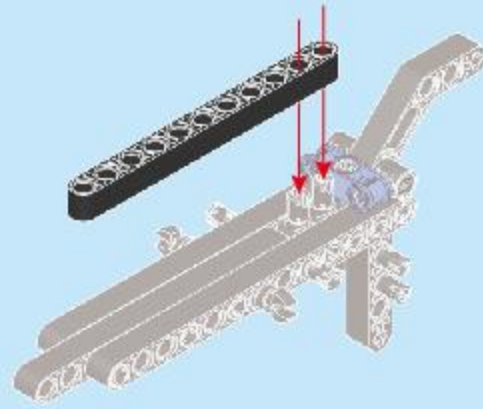

27

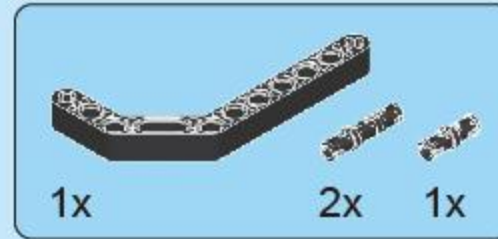
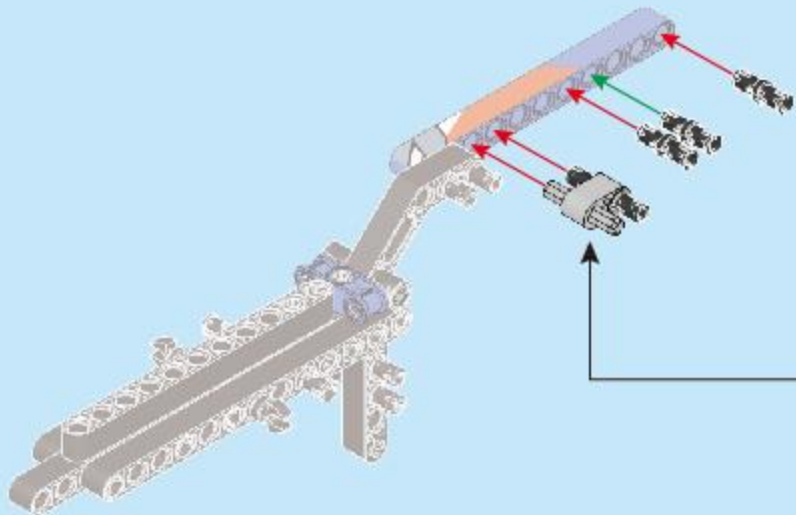
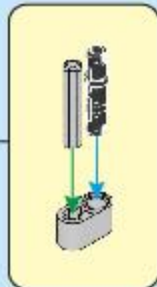
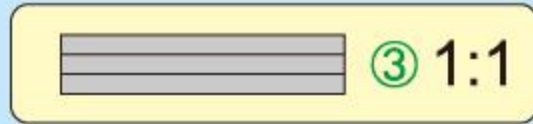

28

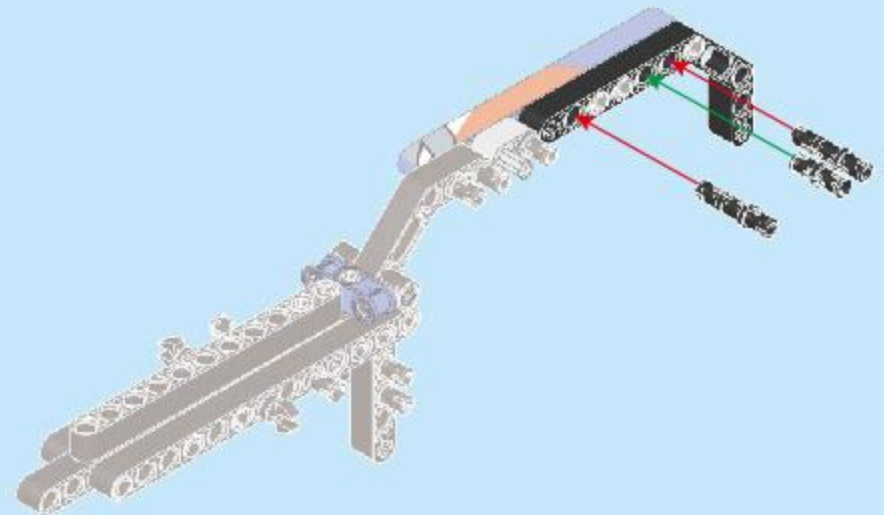

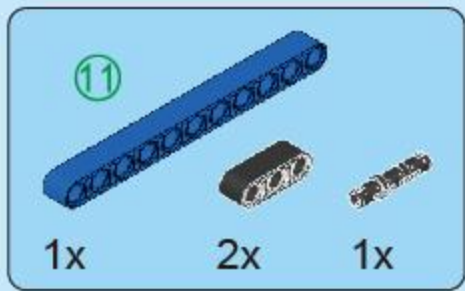

29

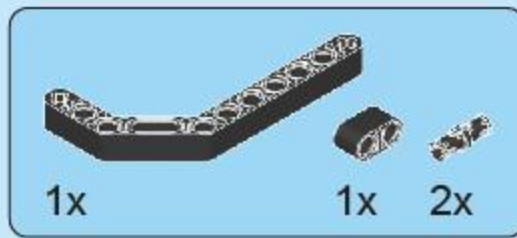
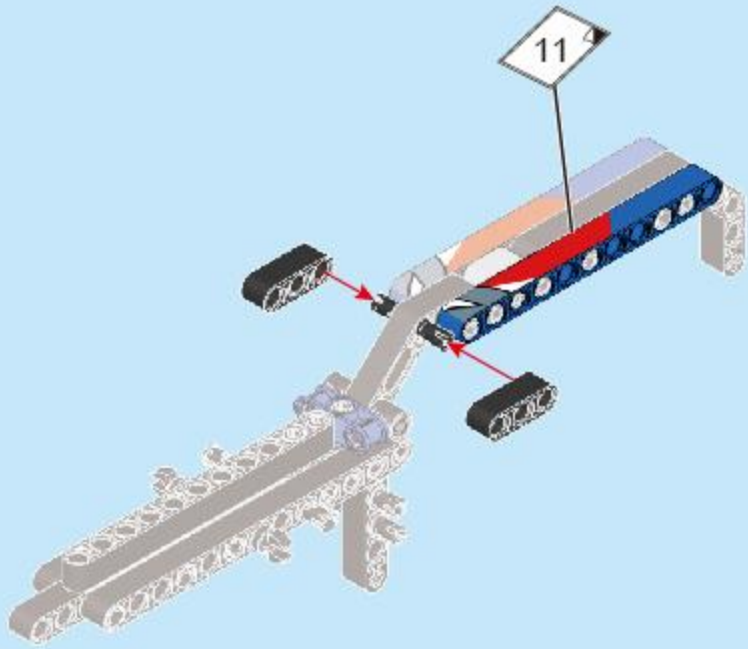

30

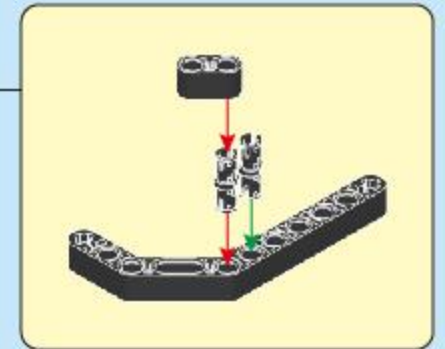
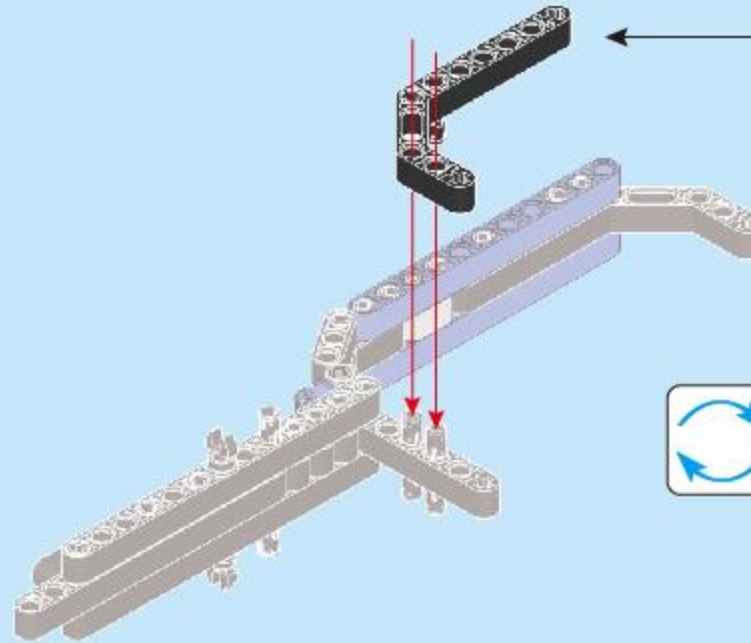

31

32

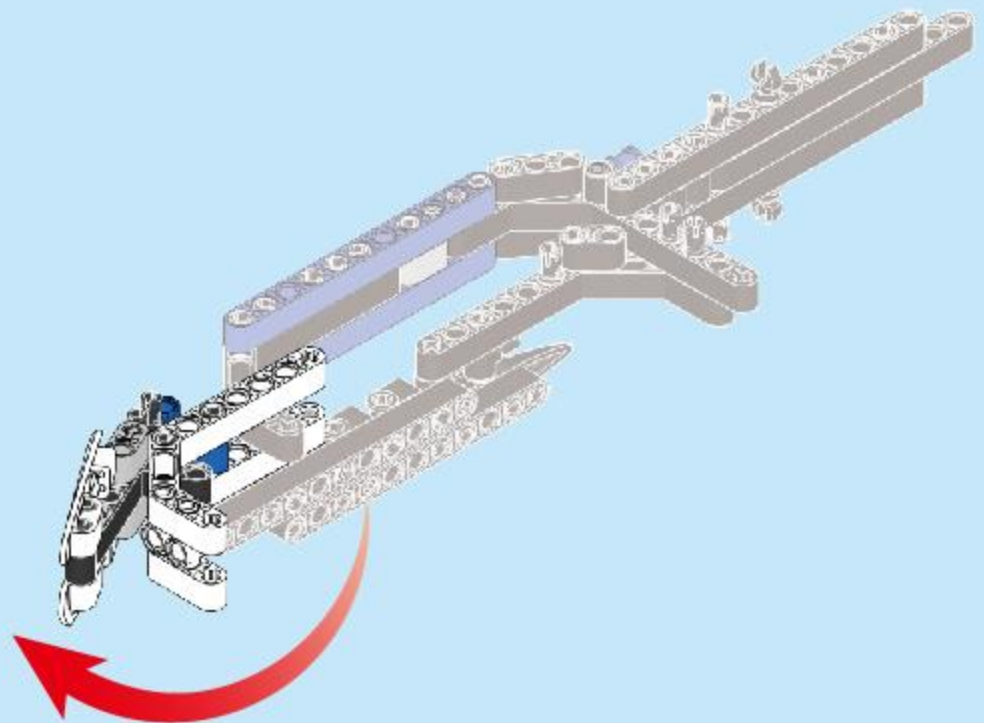
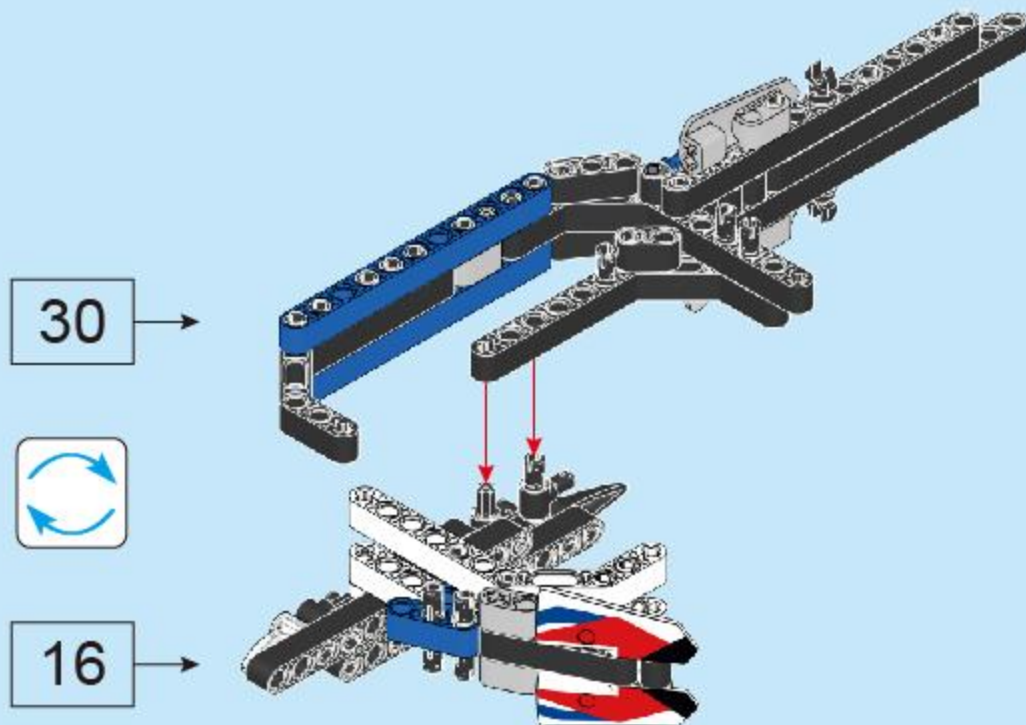

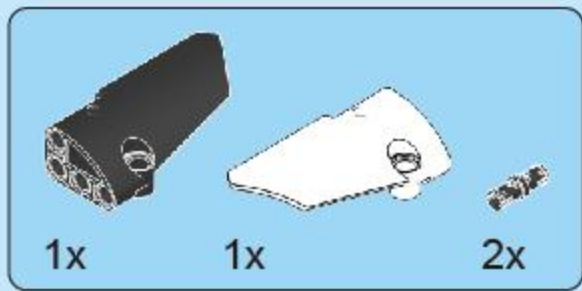

33

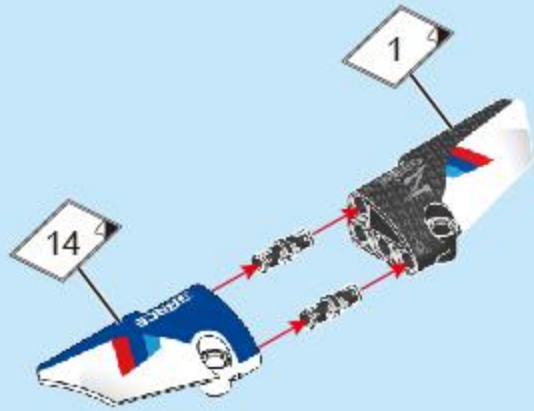

34

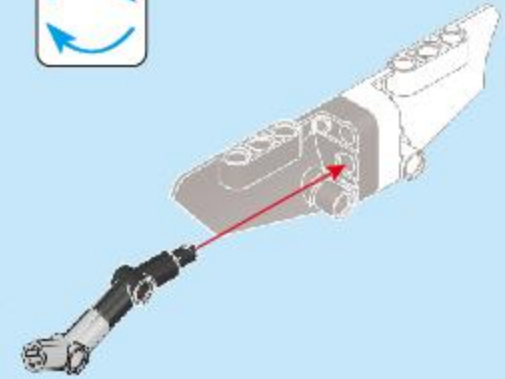
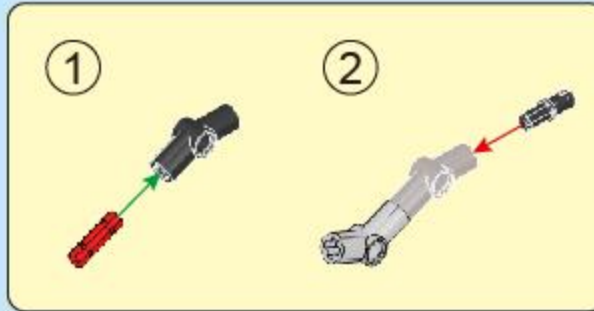

35



36

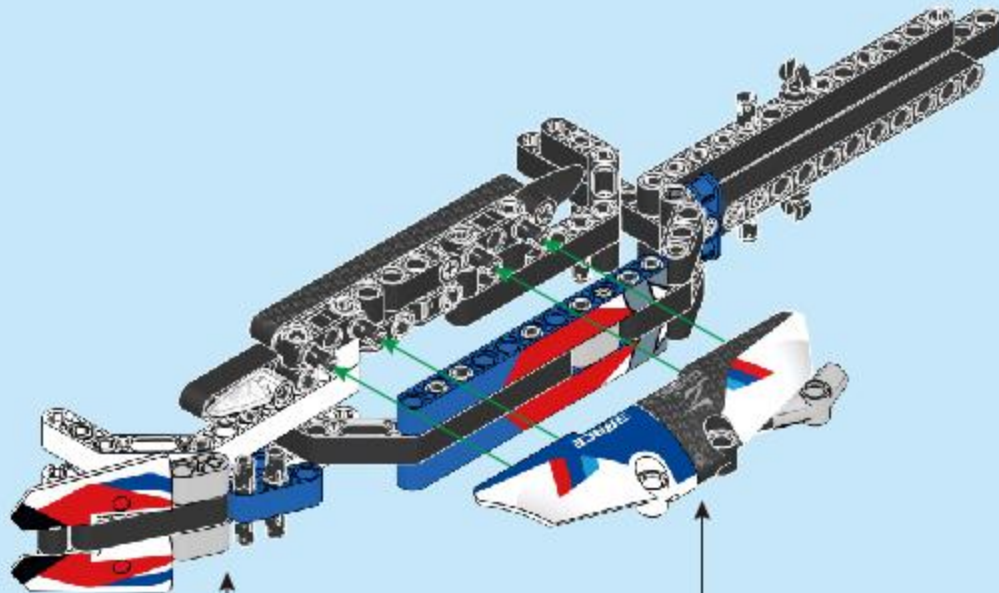

32



34

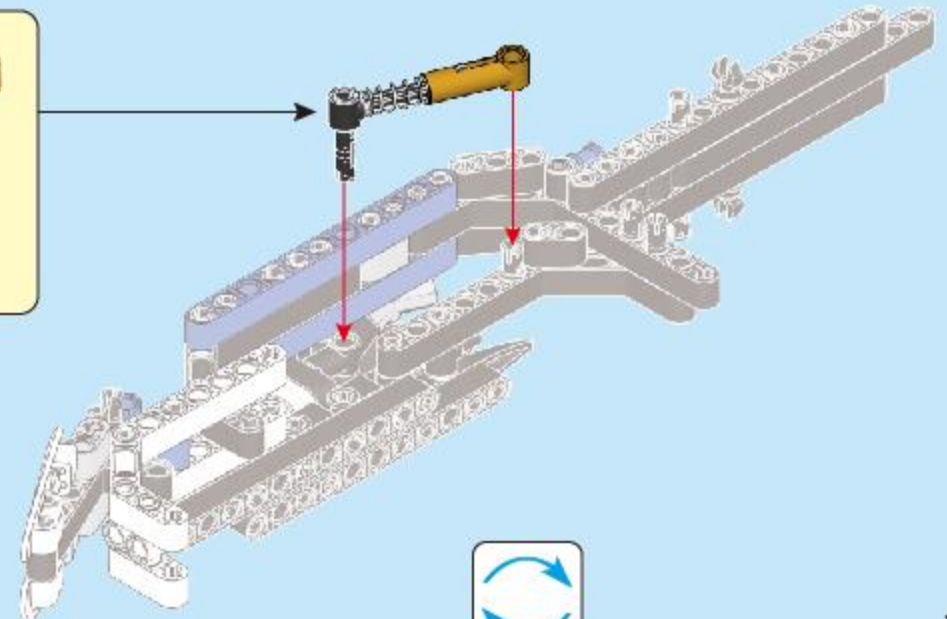
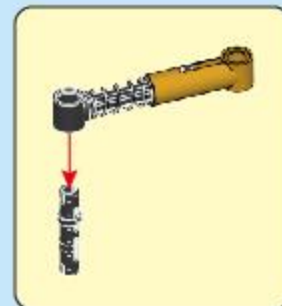

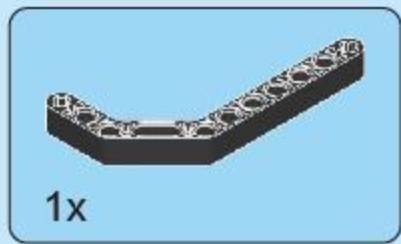

37

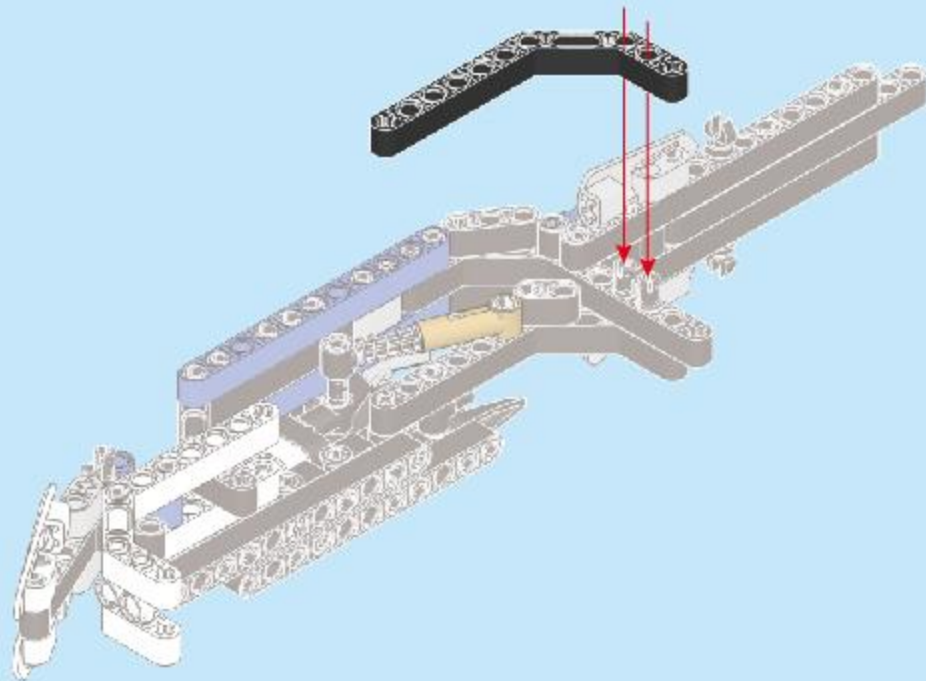

38

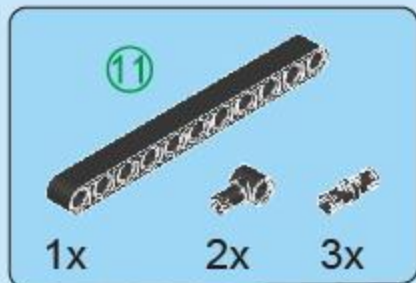
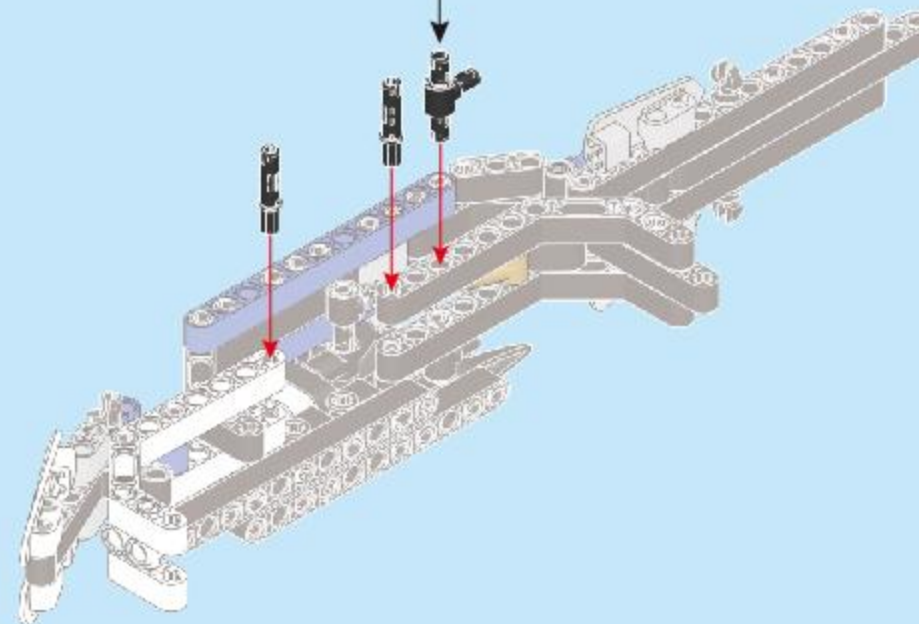

39

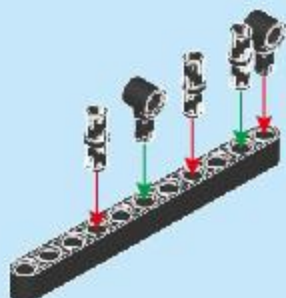

40

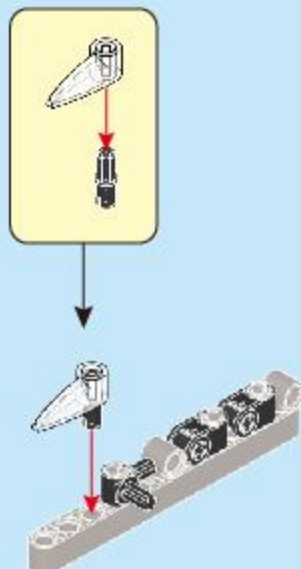

41

40



38

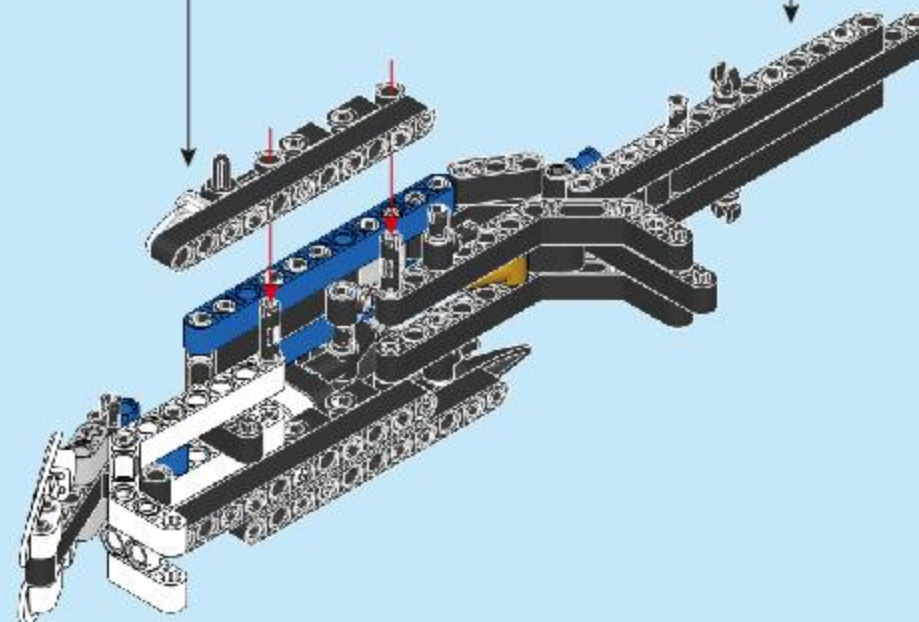



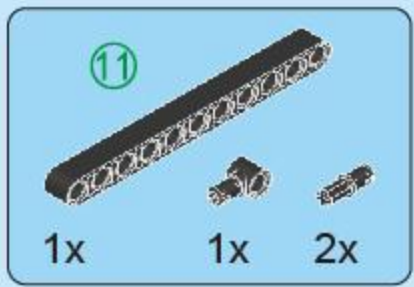

42

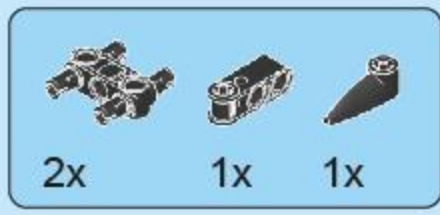
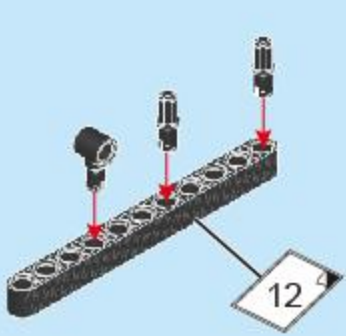

43

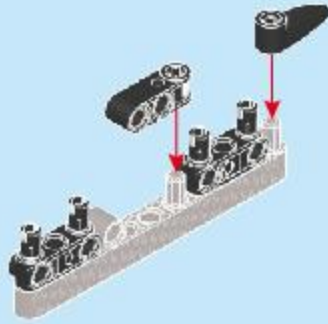

44



43

41

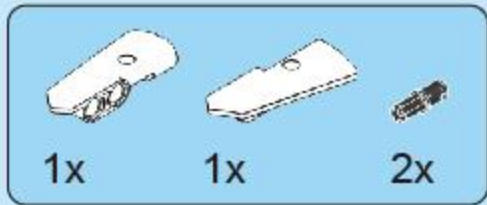
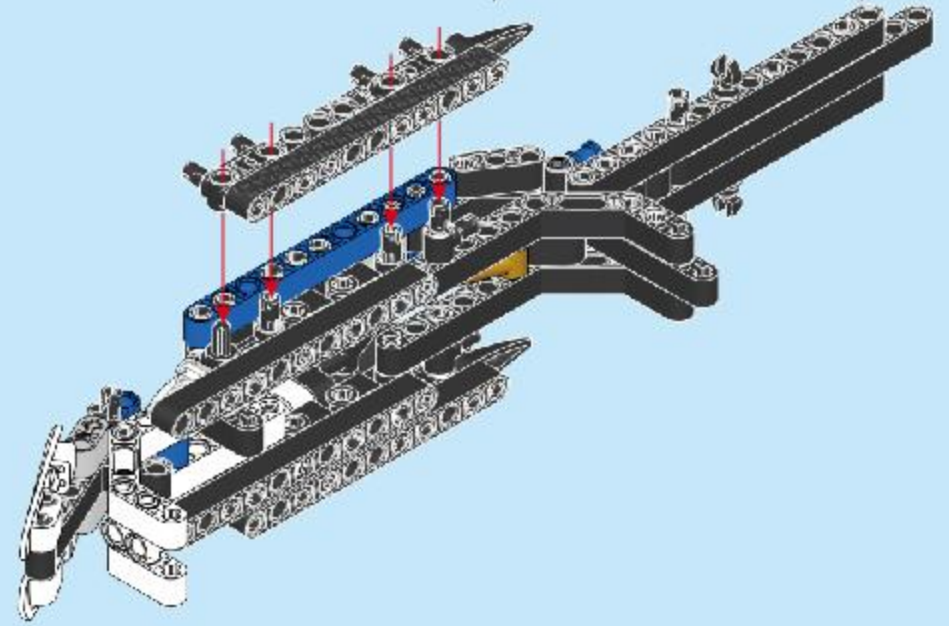

45

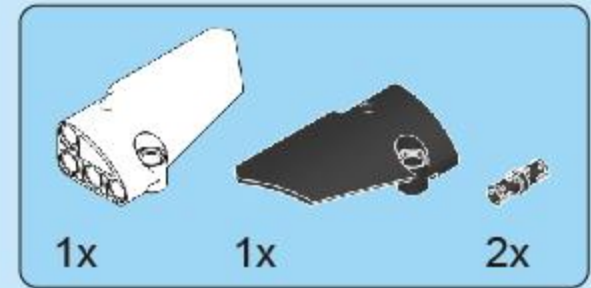
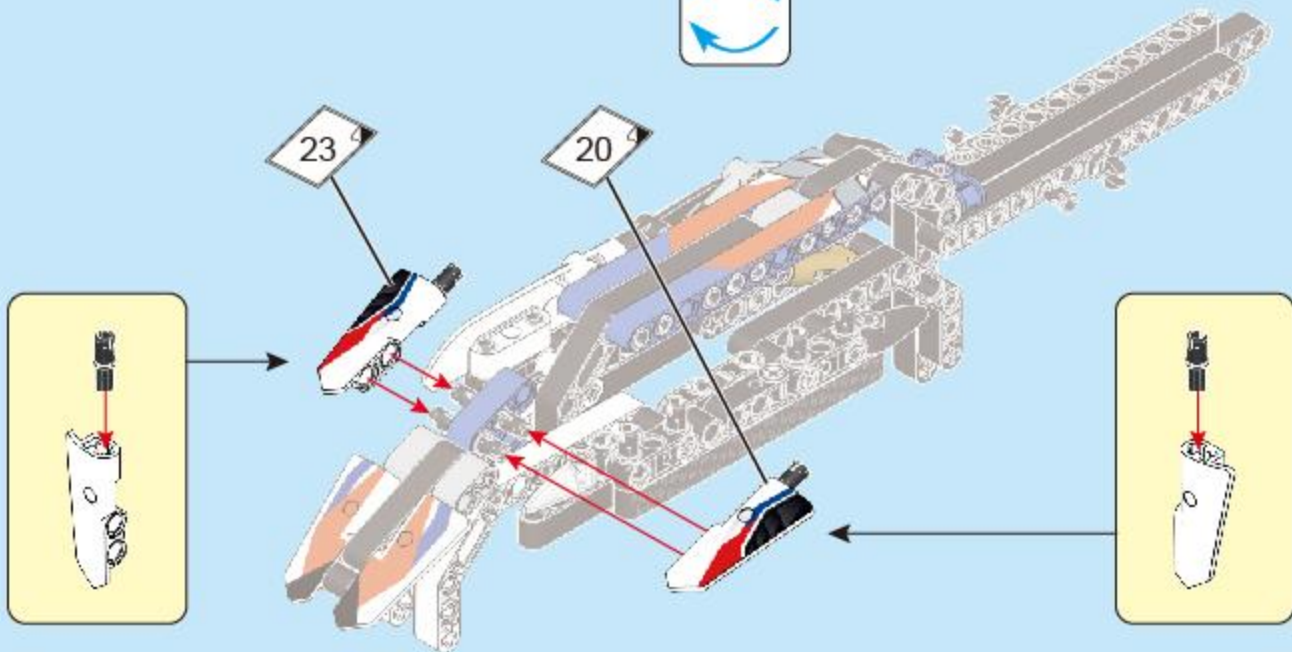

46

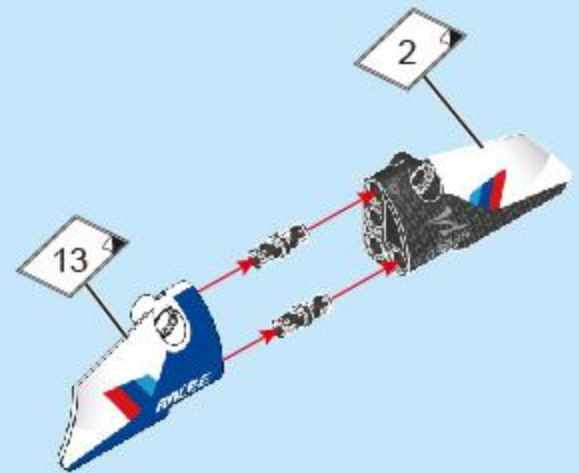



47

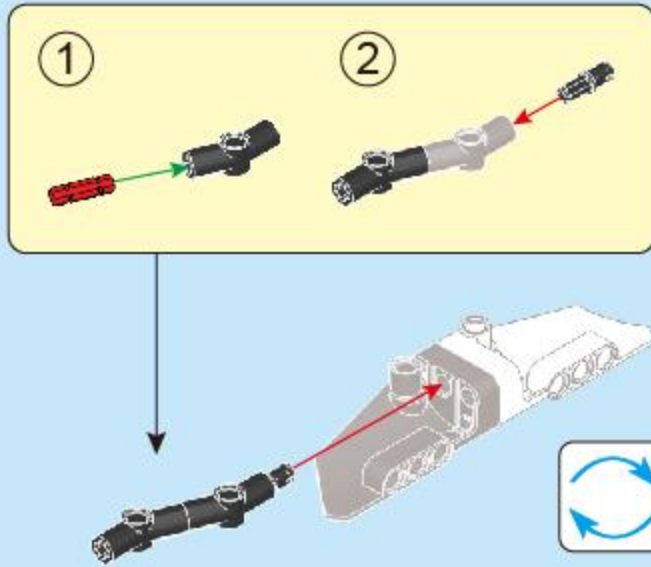

48

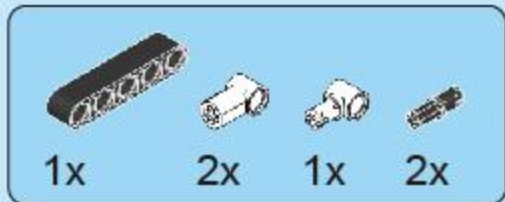
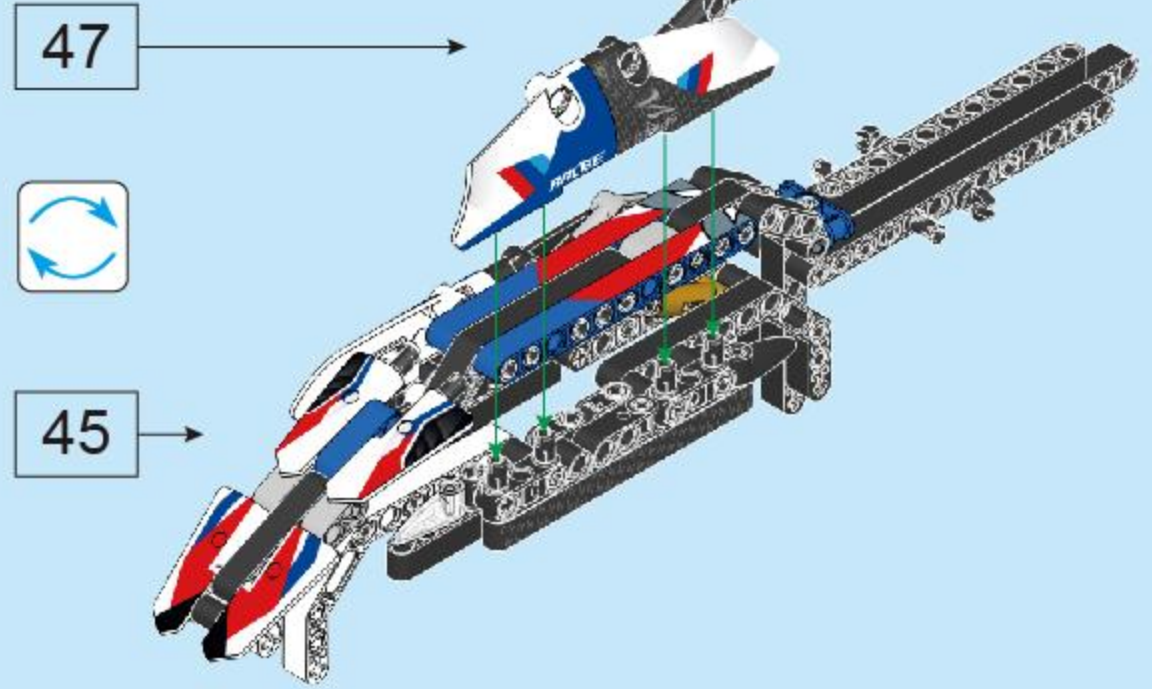

49

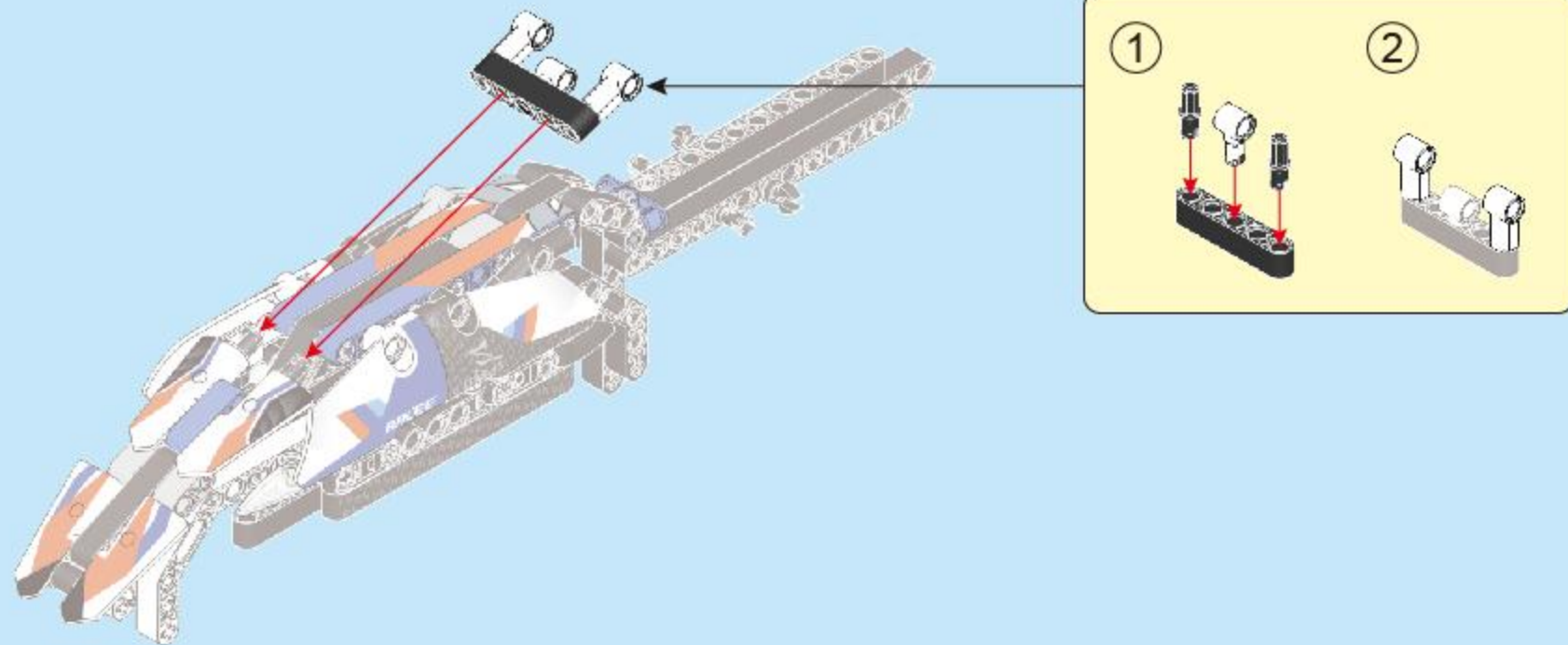

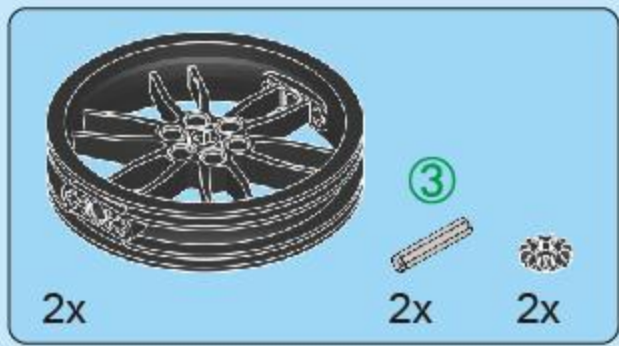

50

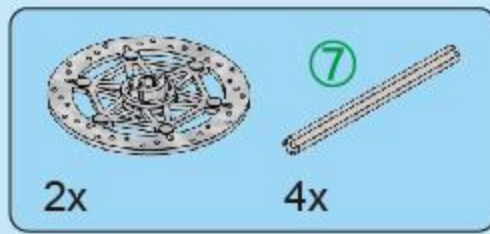
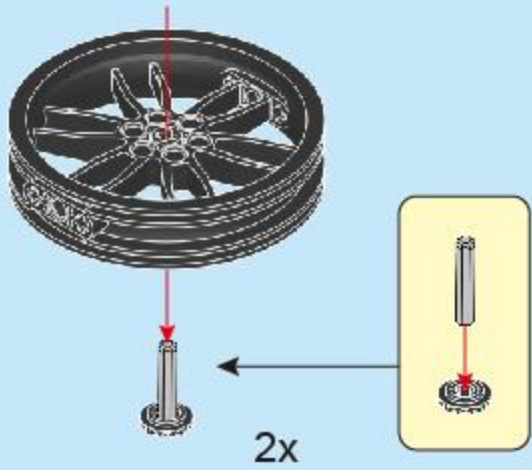

51

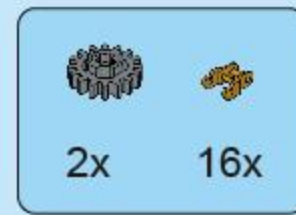
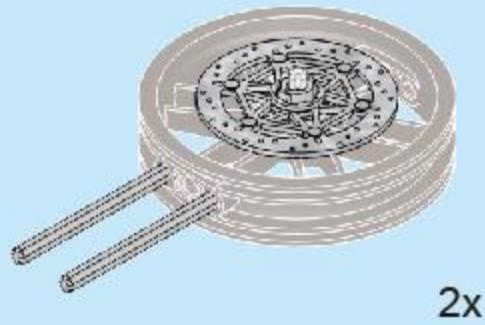

52

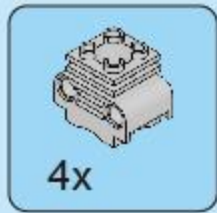
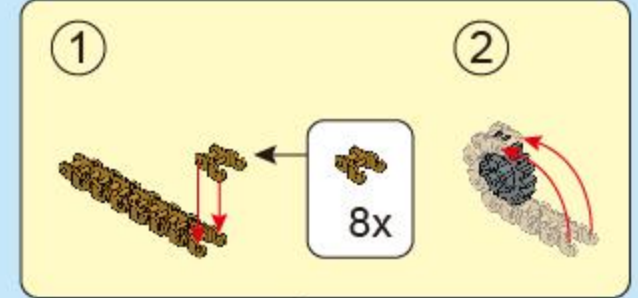

53

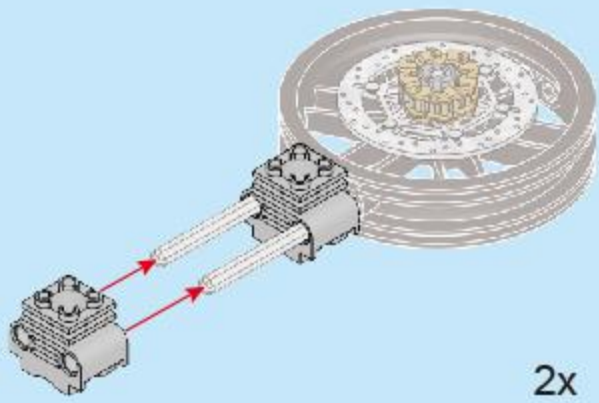

54

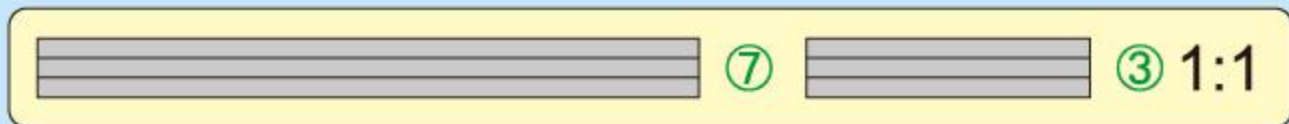
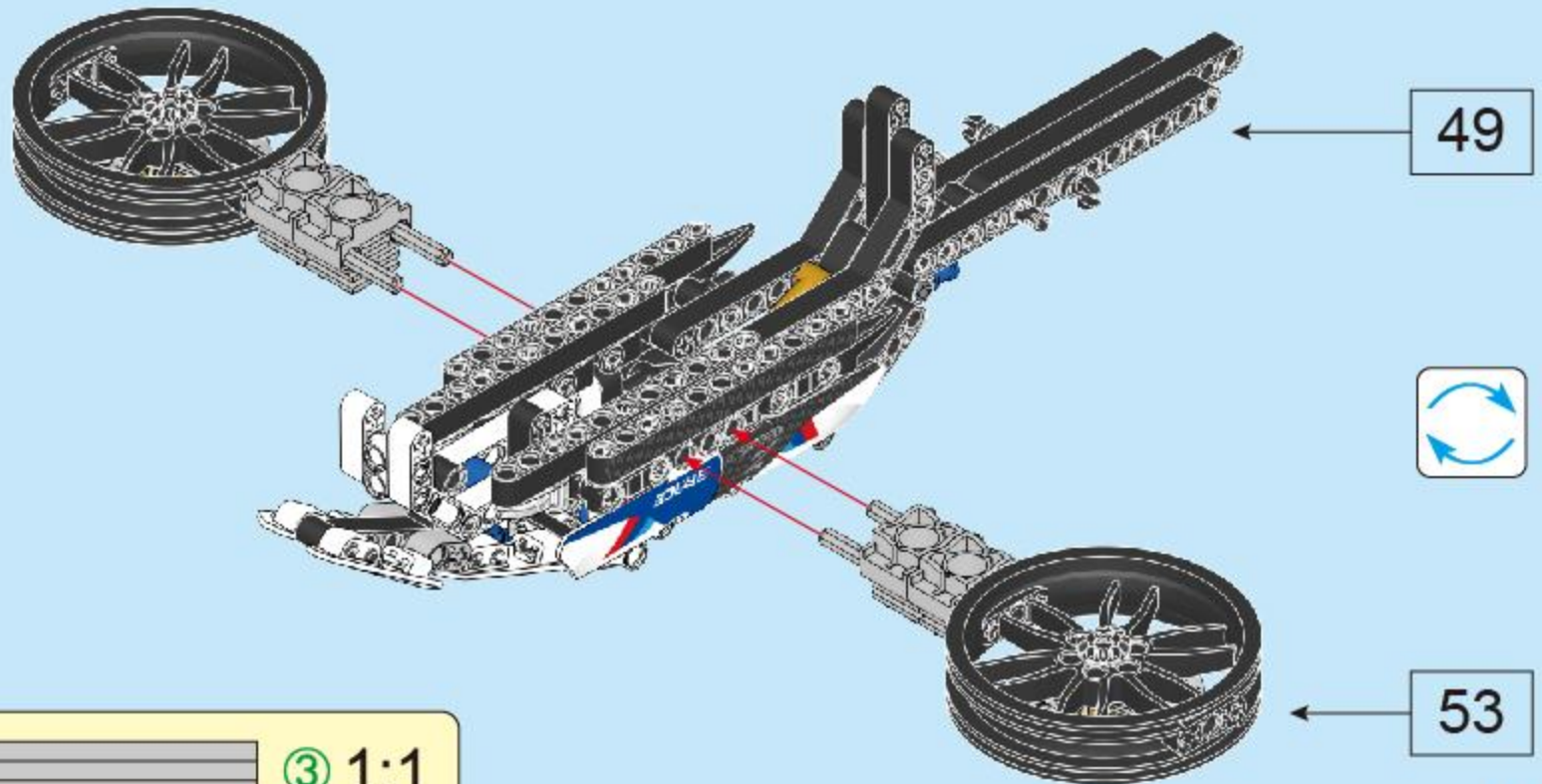

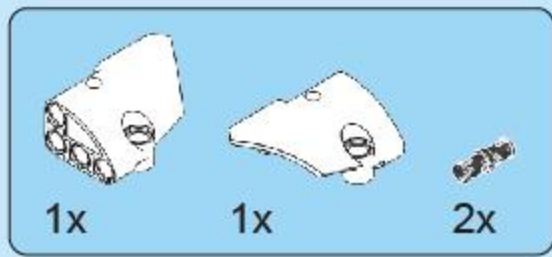

55



56

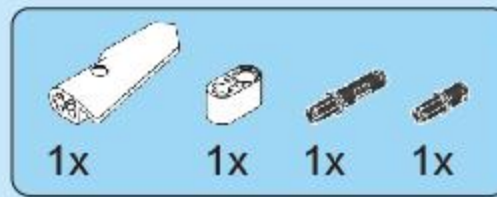

57

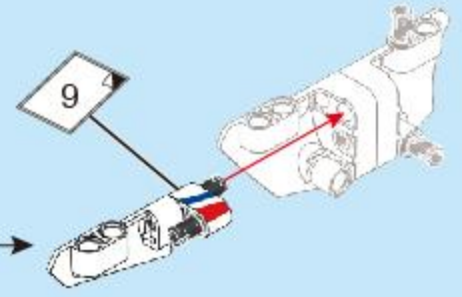
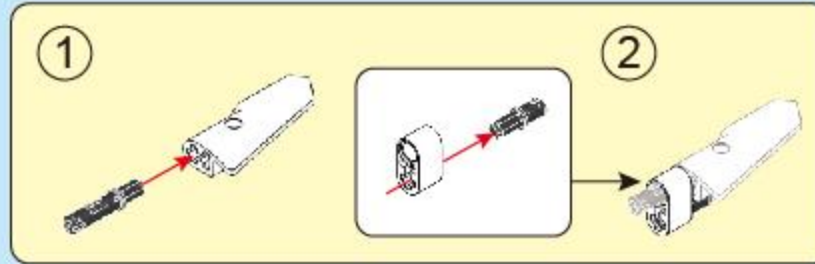
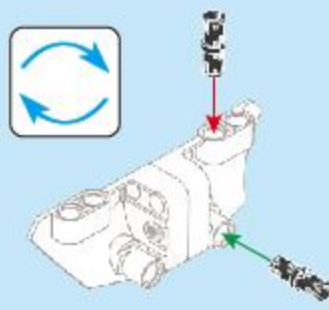
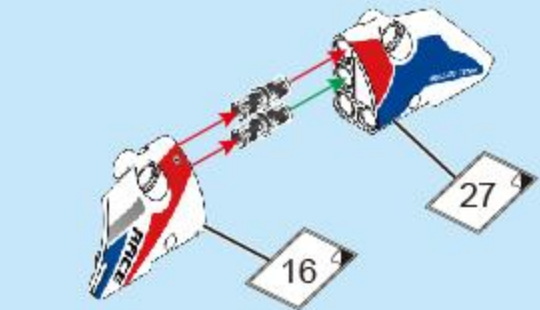
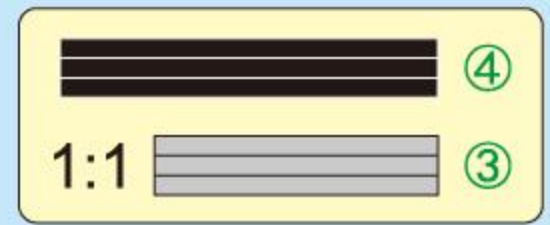

58

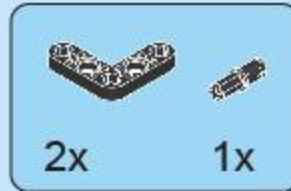

59

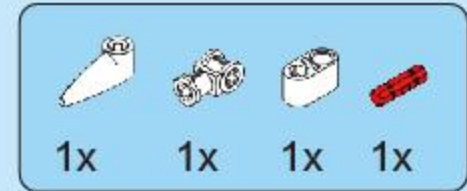

60

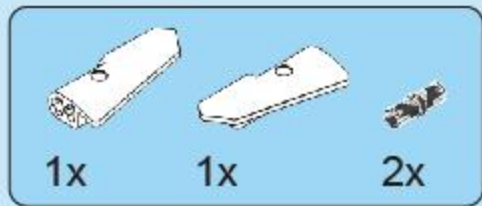
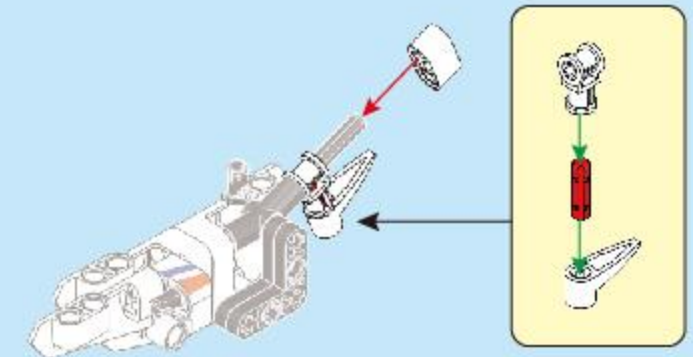
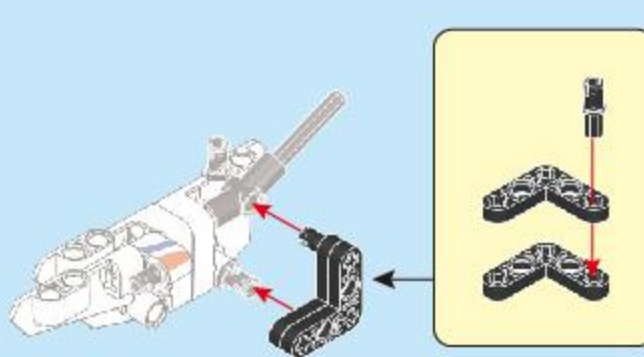
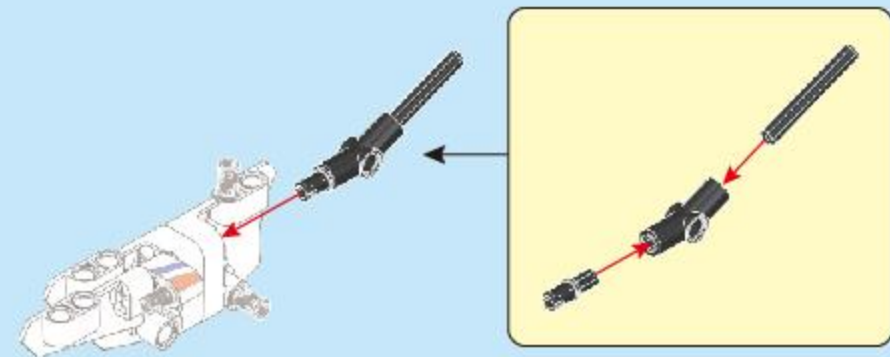

61

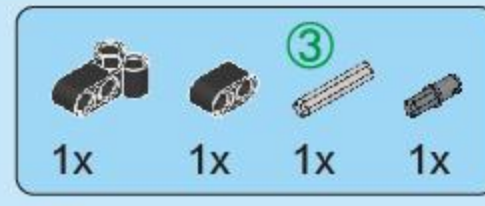

62

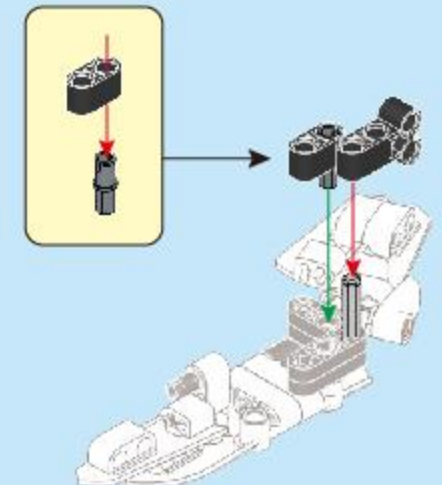
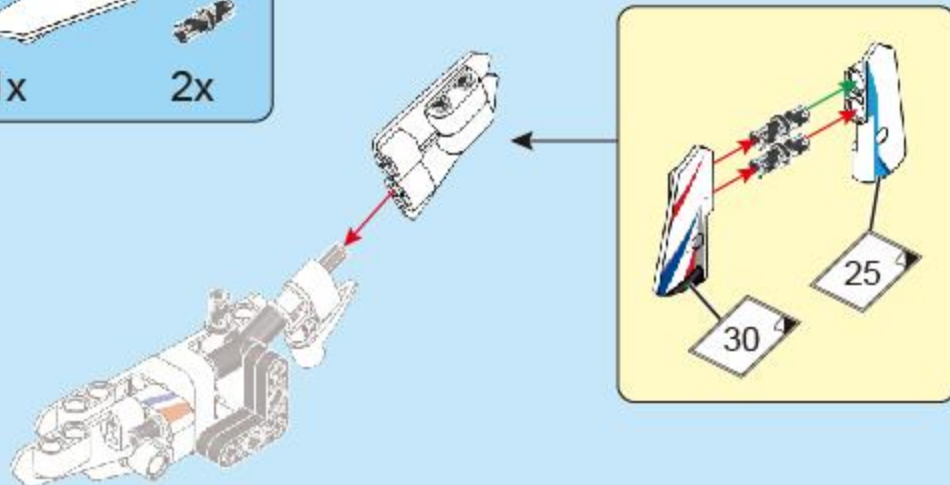

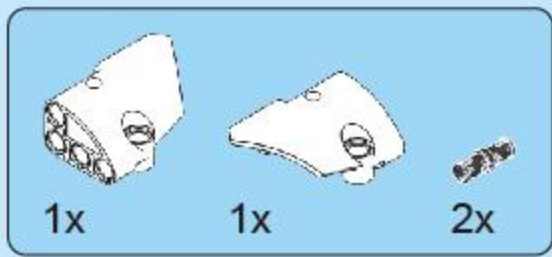

63

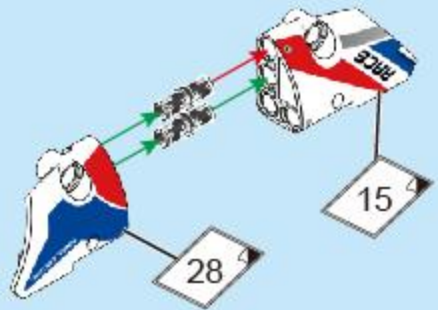

64

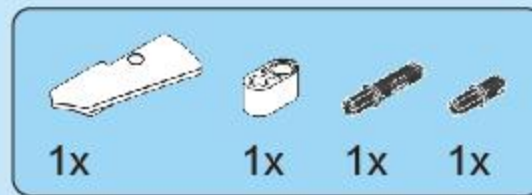
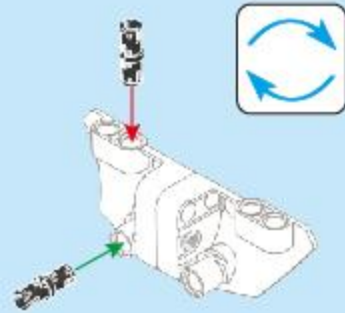

65

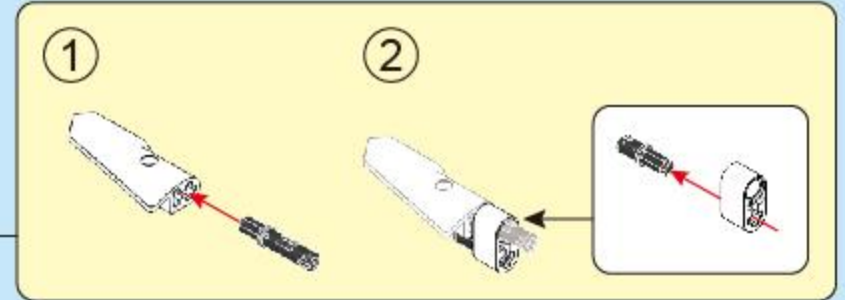
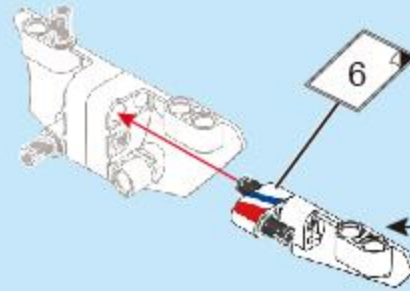

66

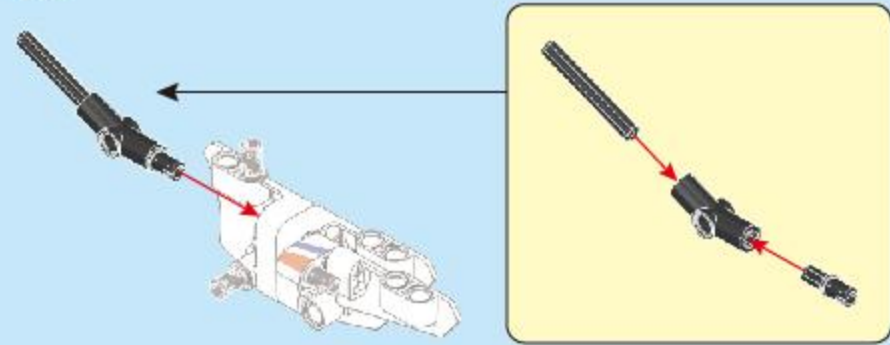

67

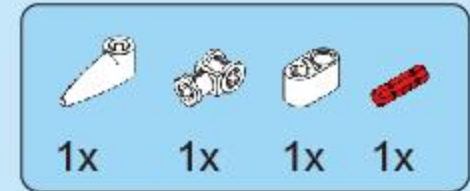
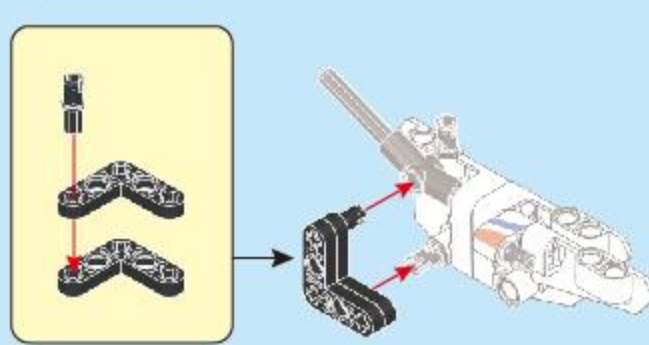

68

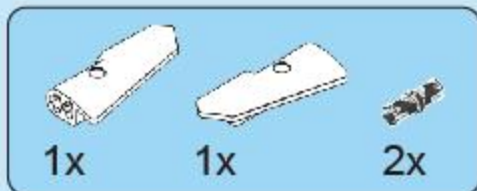
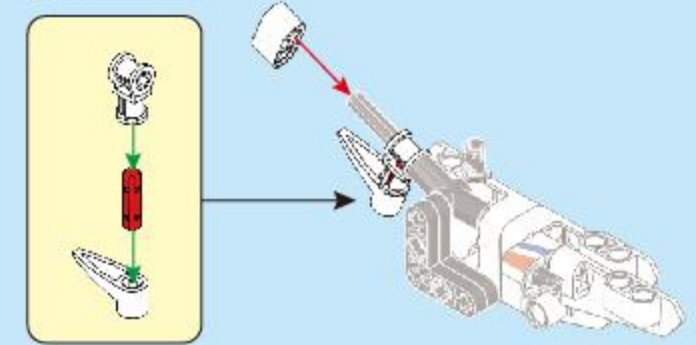

69

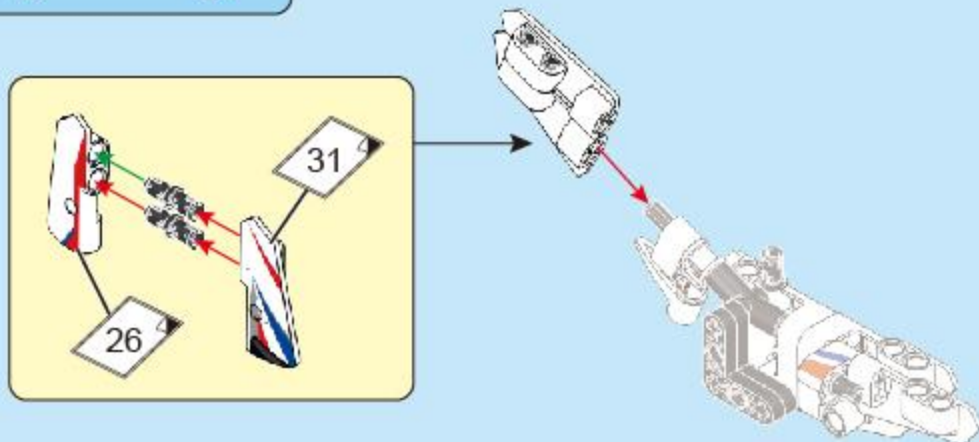

70

69



62

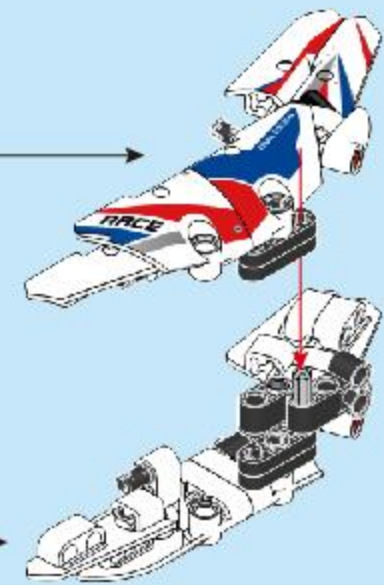

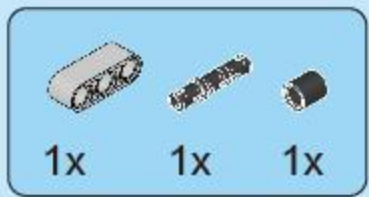

71

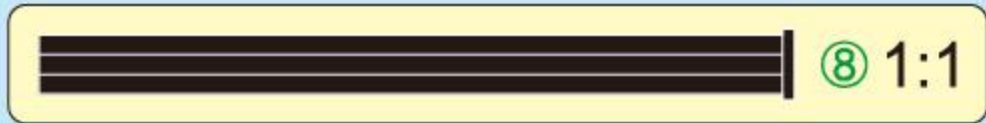
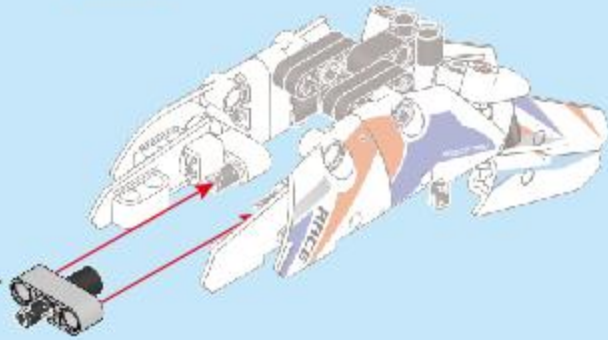
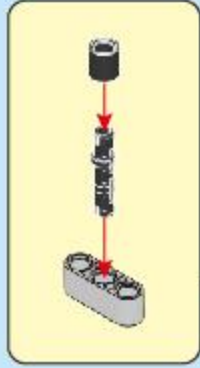

72

71

54

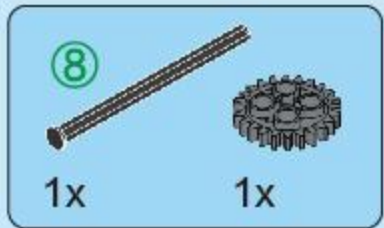
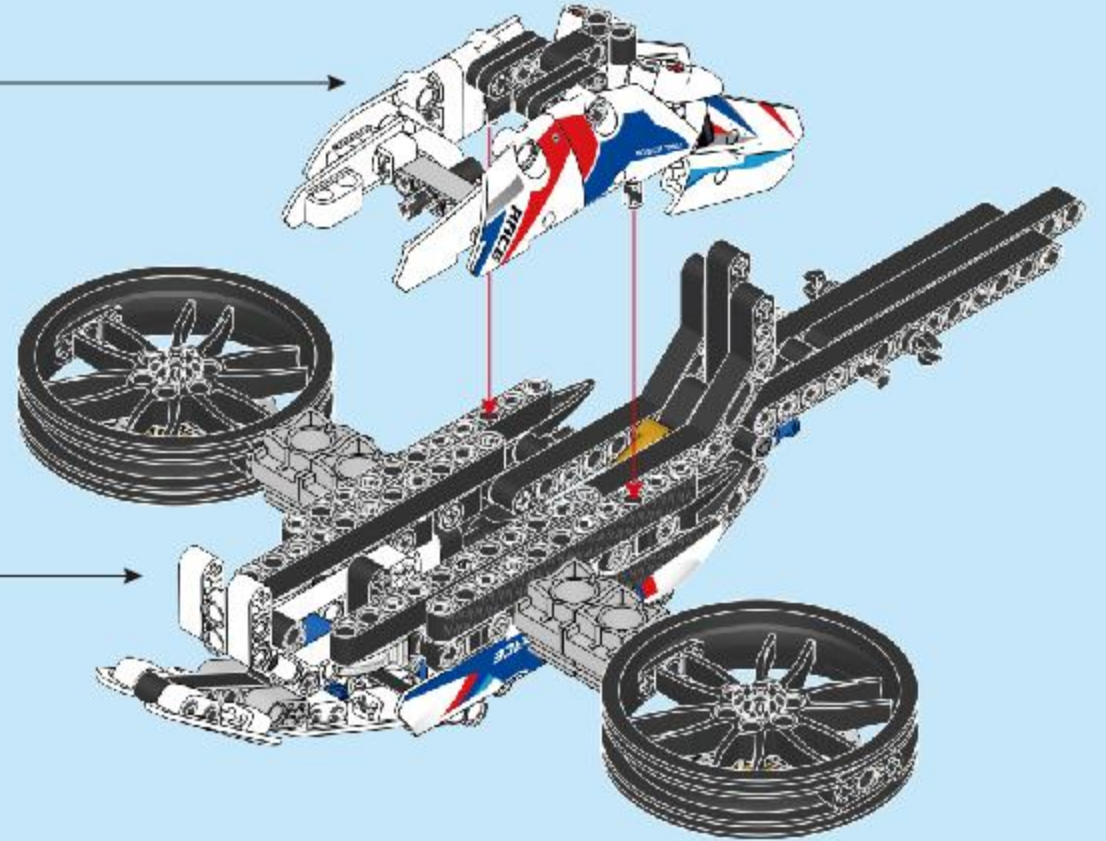

73



74

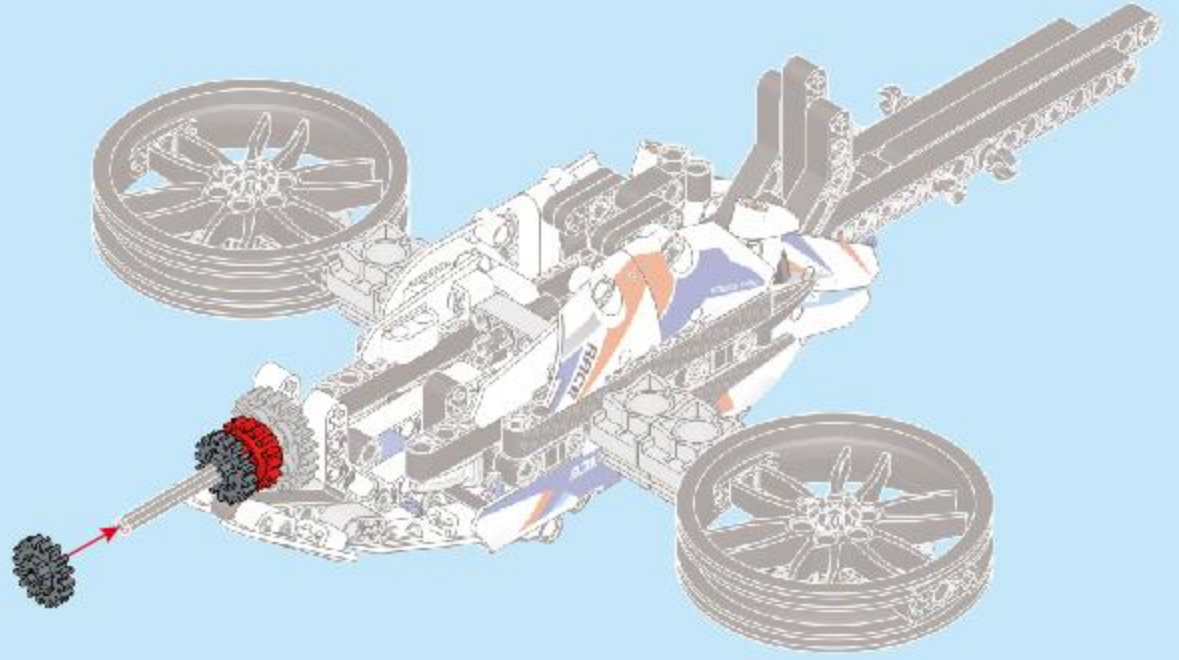
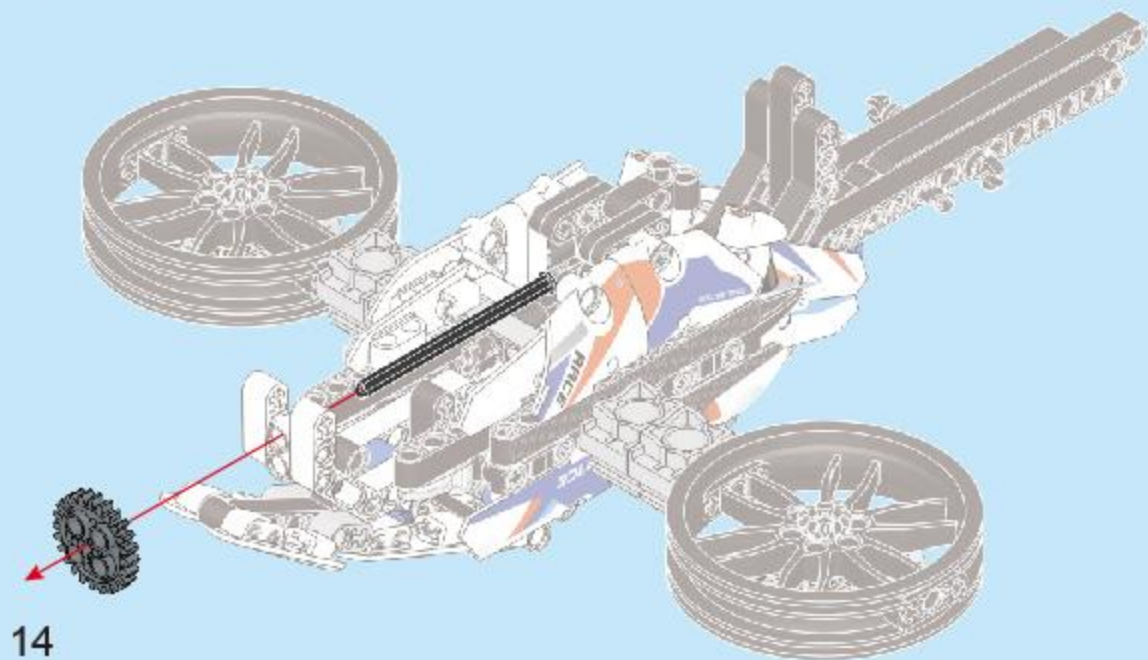



75

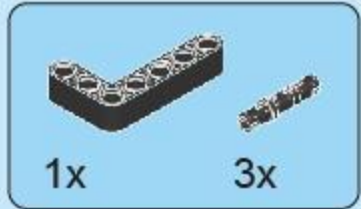
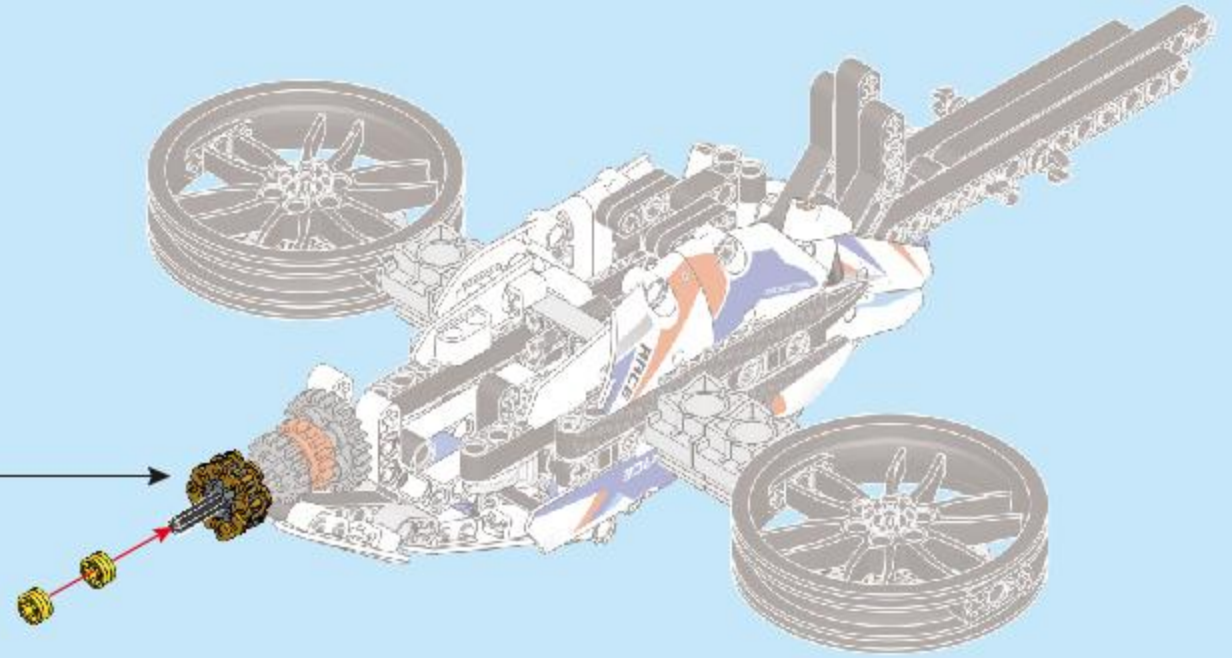
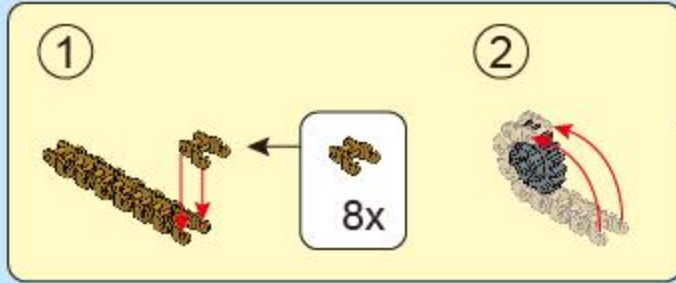

76

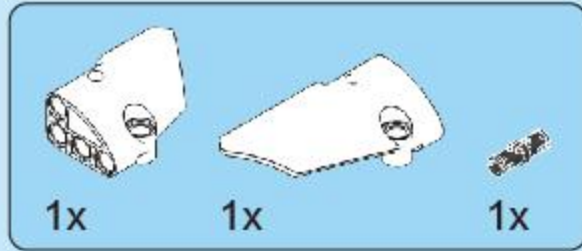

77



78



79

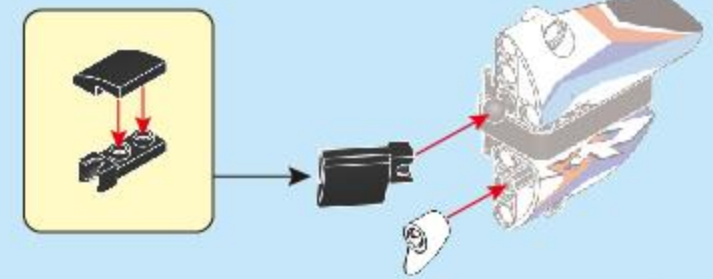
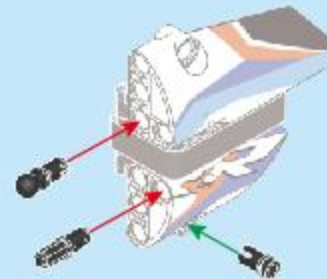
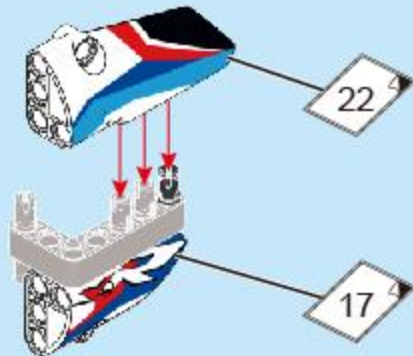

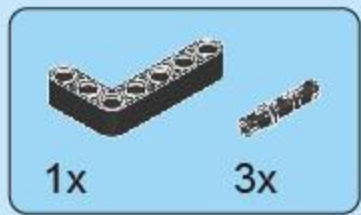

80

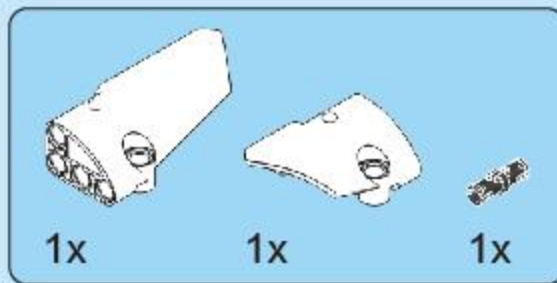

81

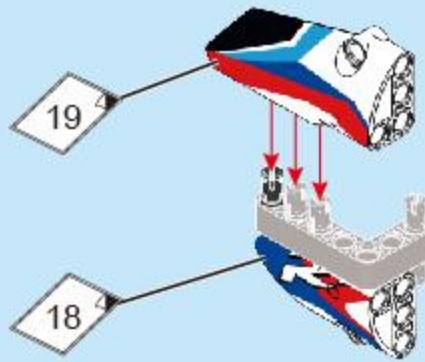

82

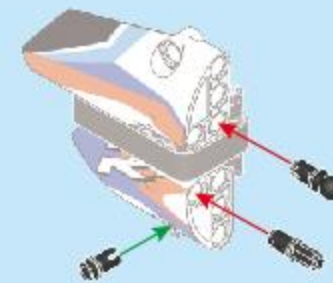

83

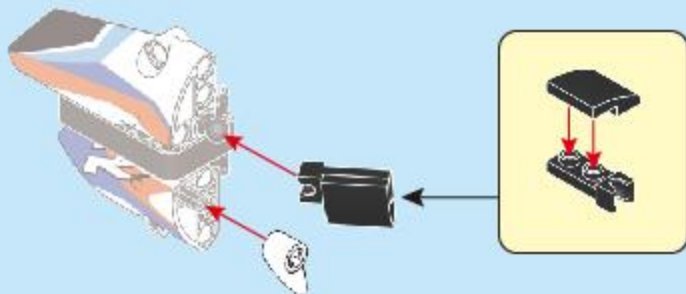

84

75



83

79

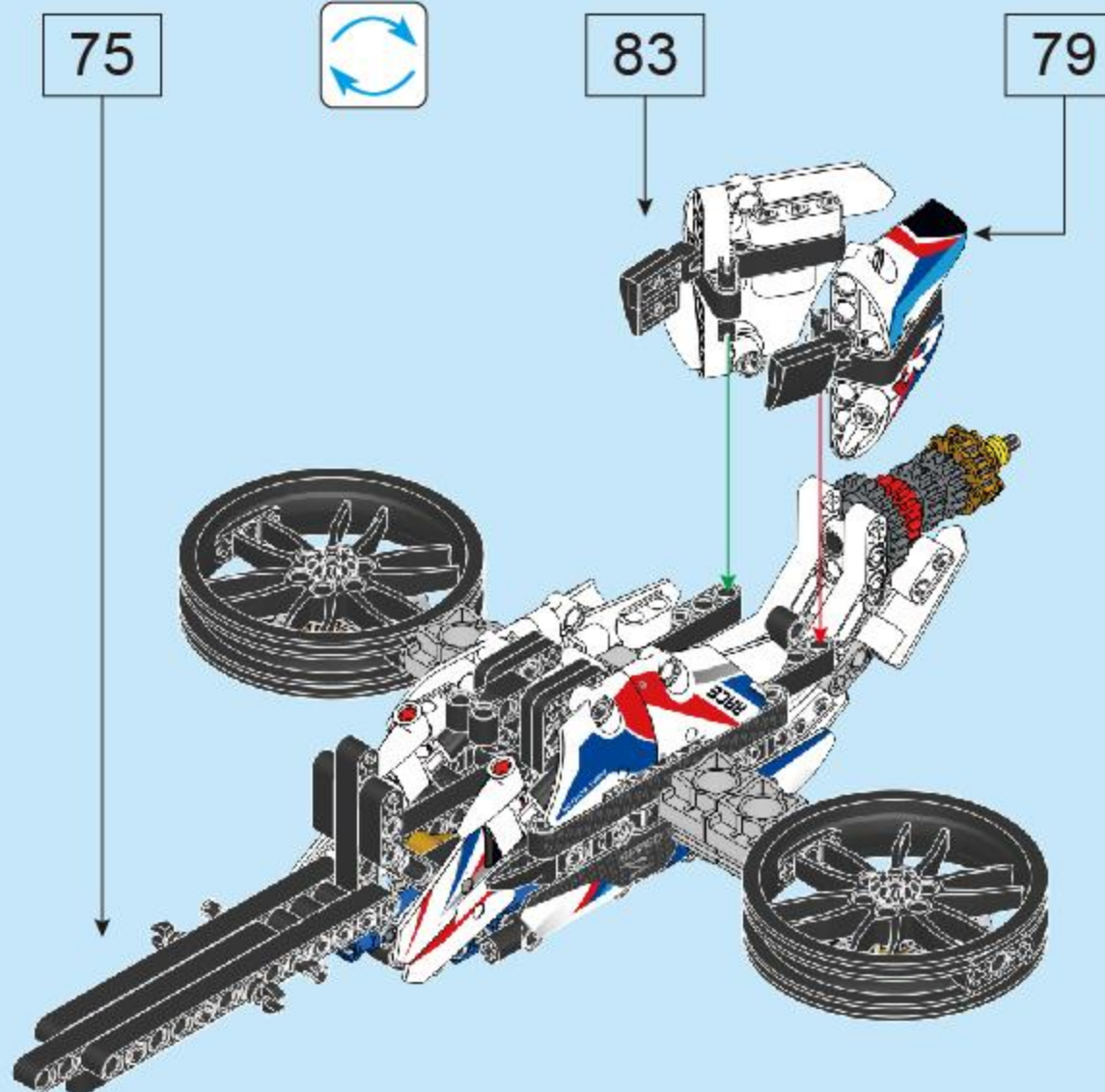



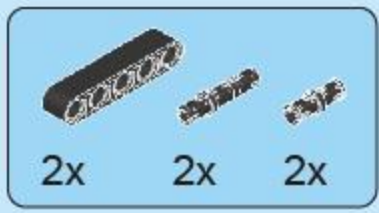

85

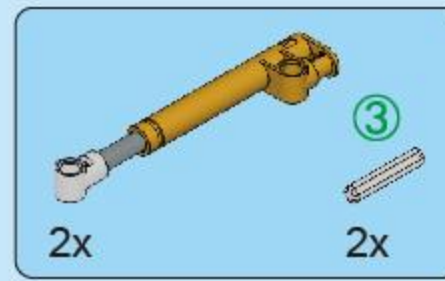
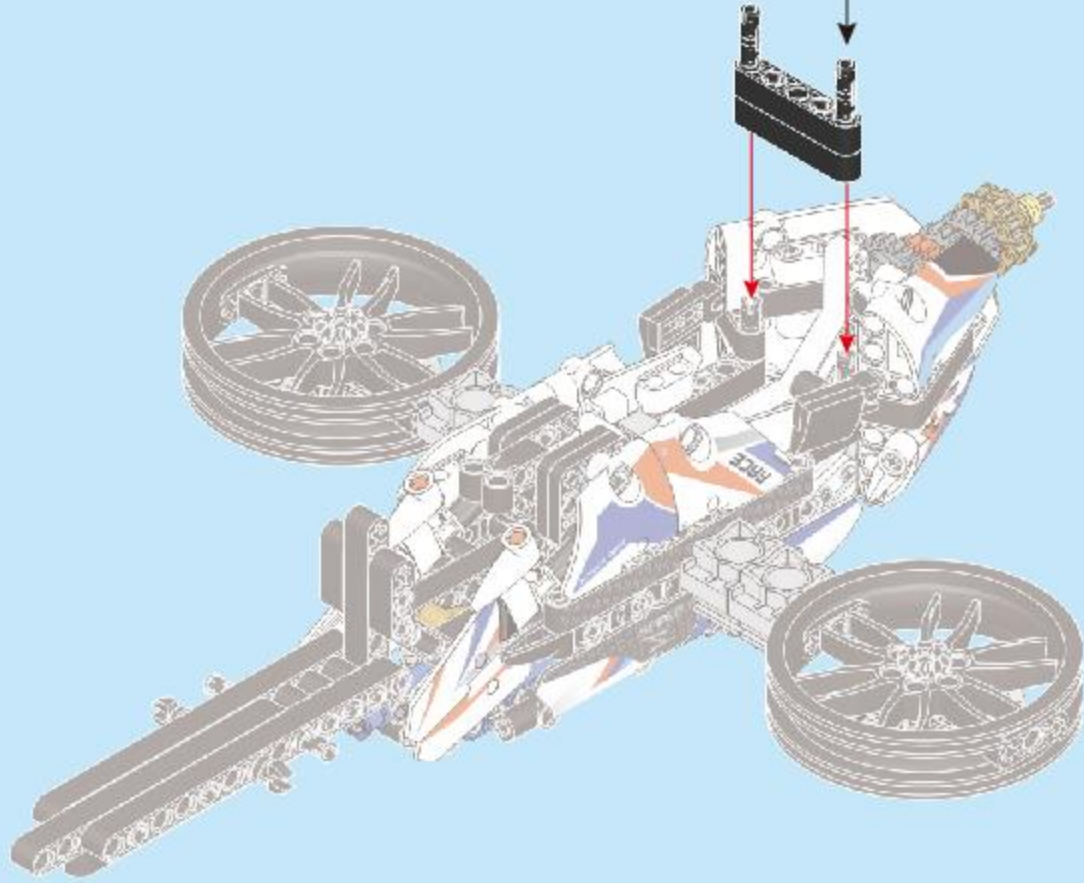
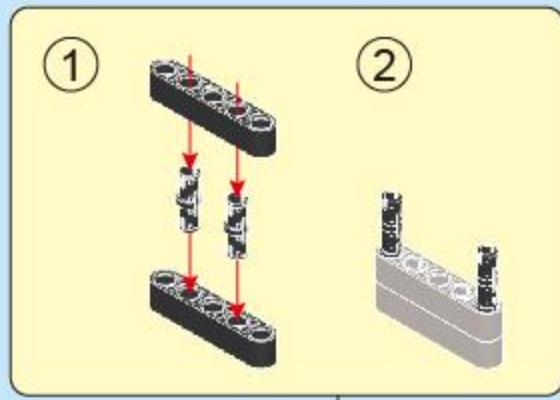

86

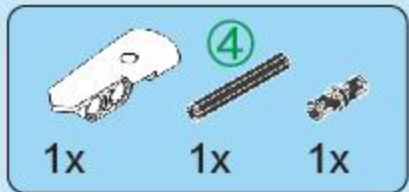
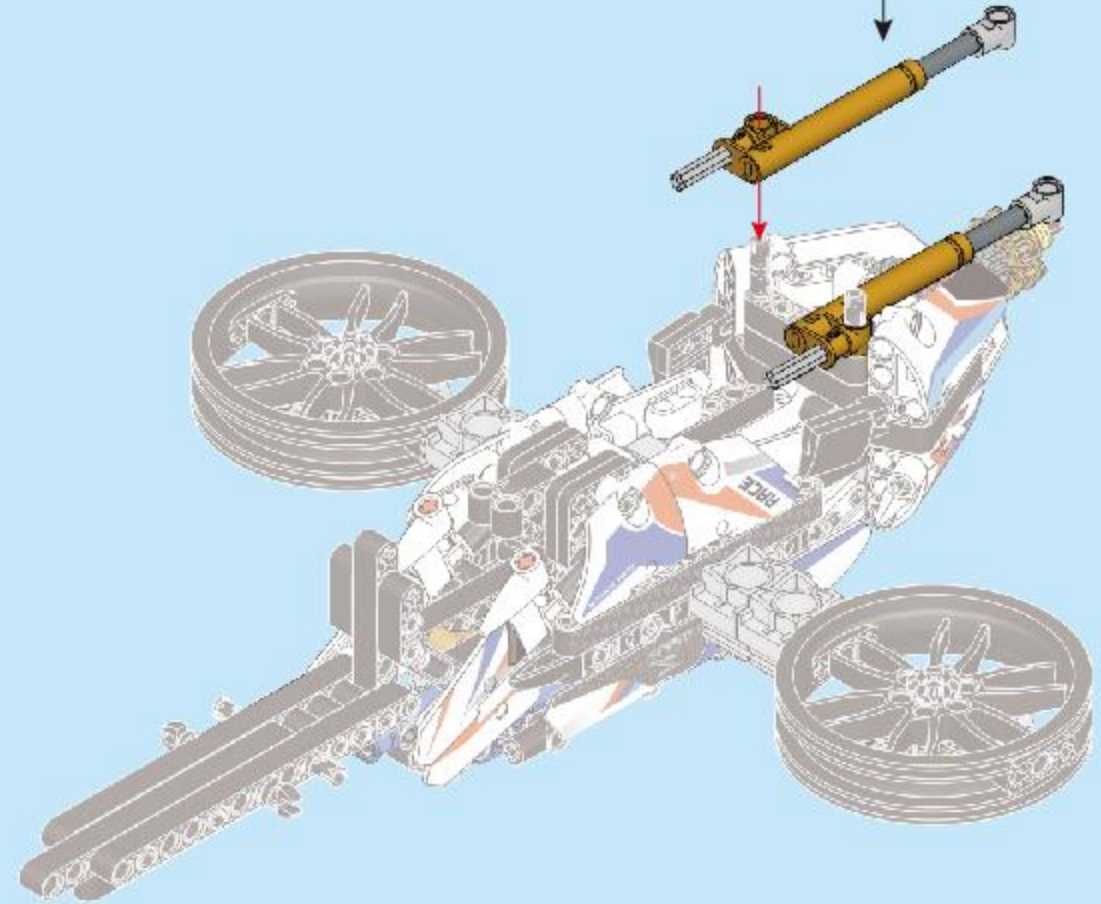
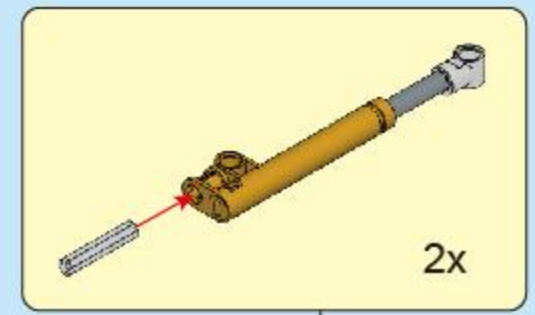

87



88

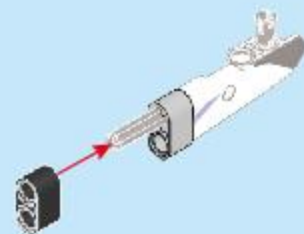
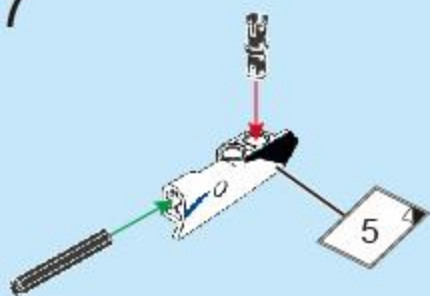

89

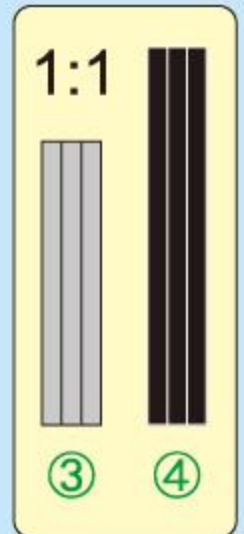
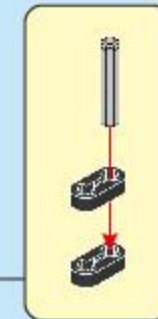
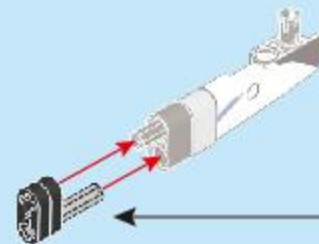

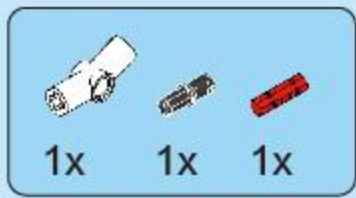

90

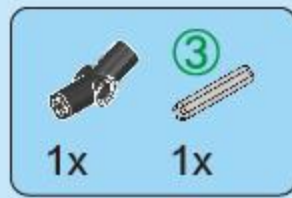
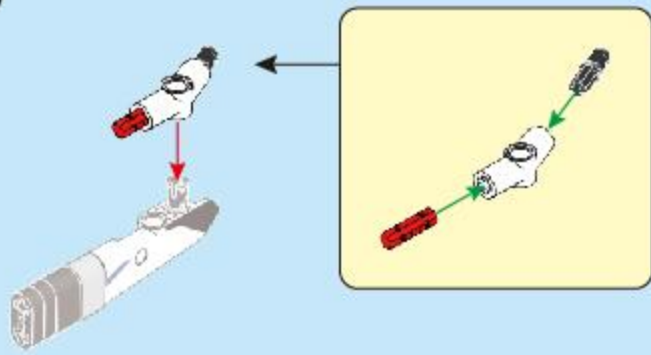

91

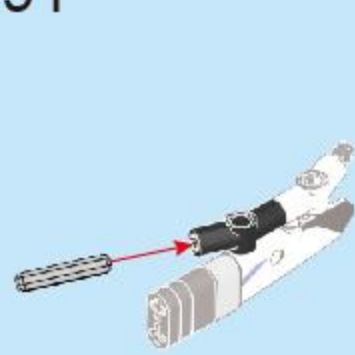

92

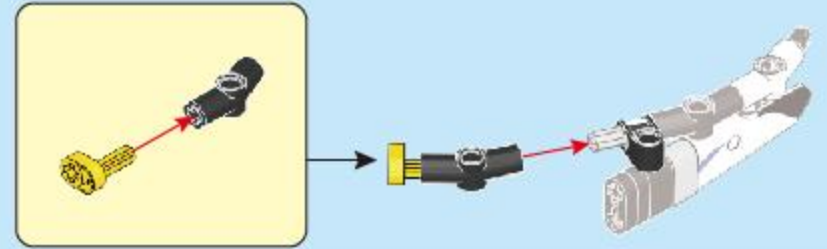

93

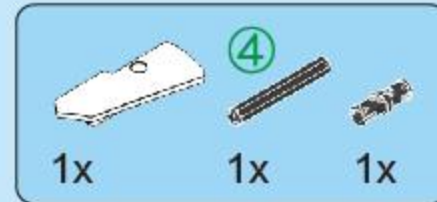
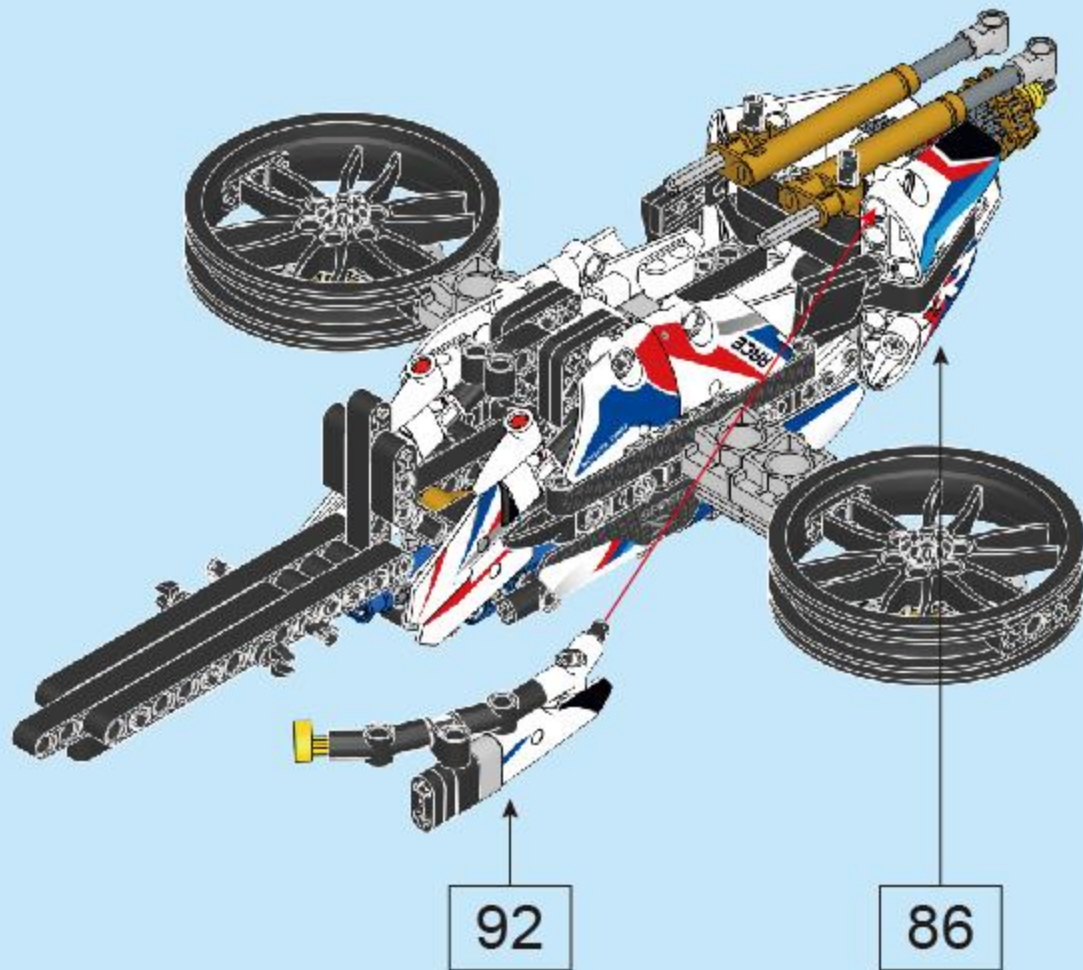
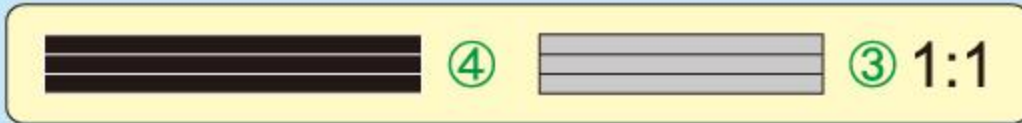

94

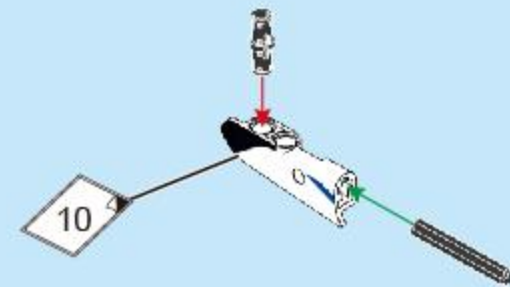

95

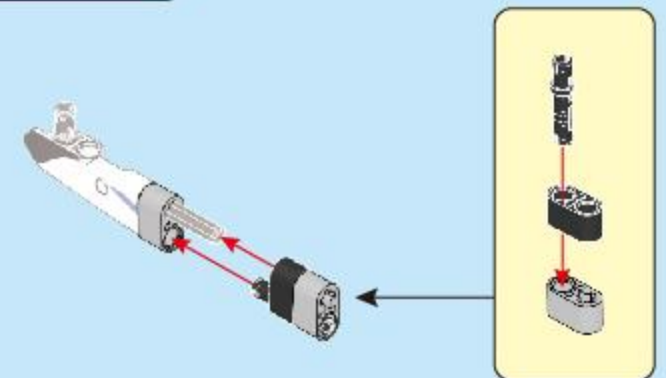

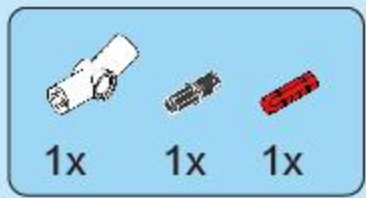

96

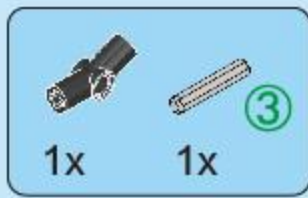
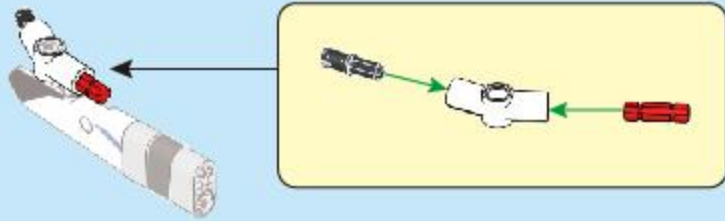

97

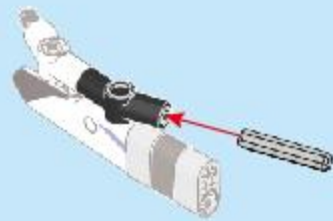

98

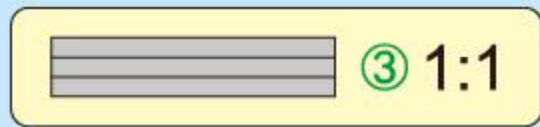

99

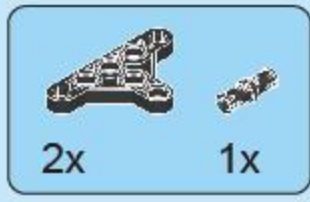
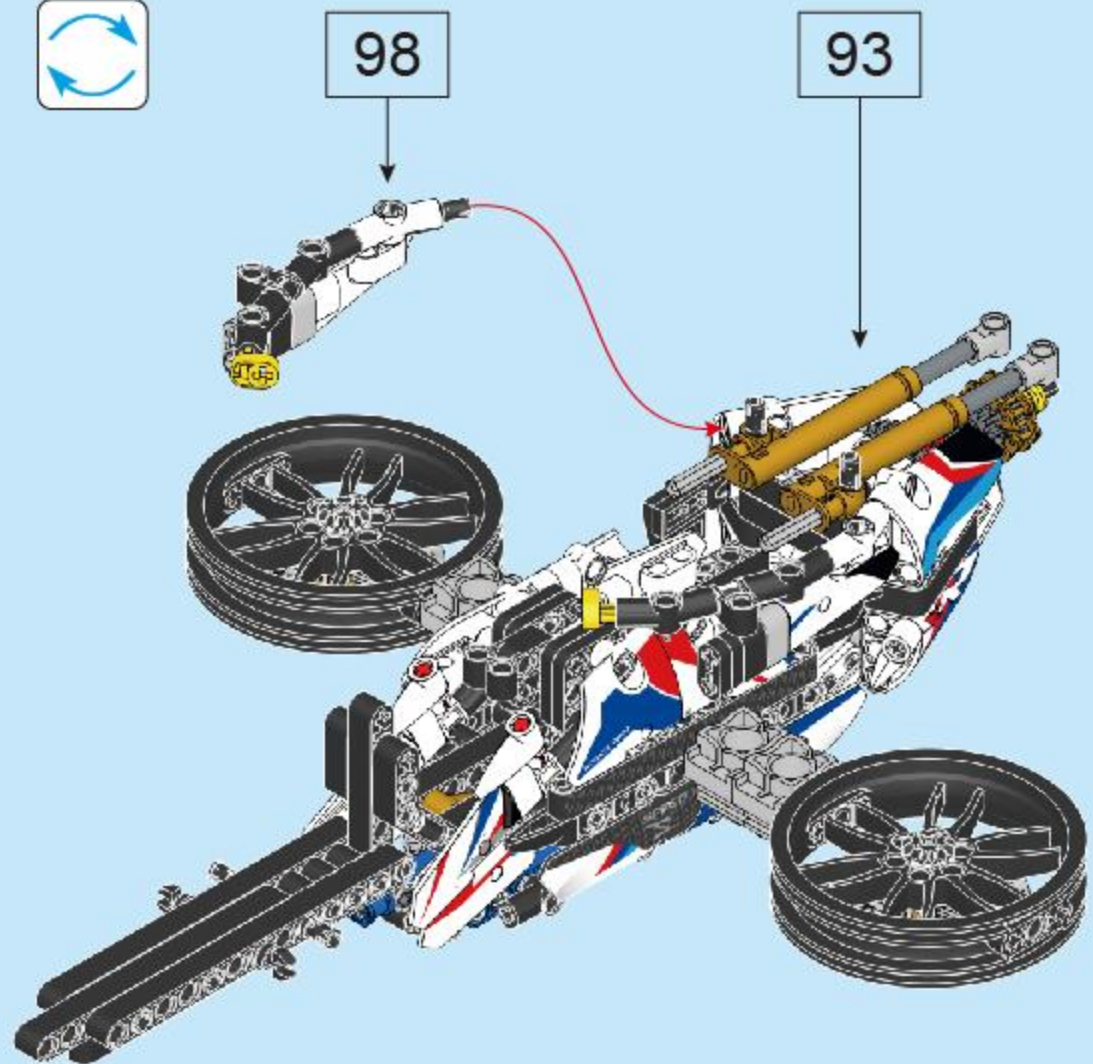

100

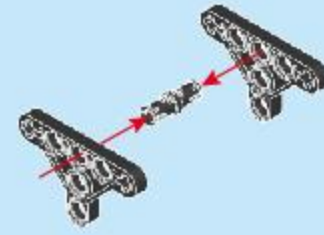

101

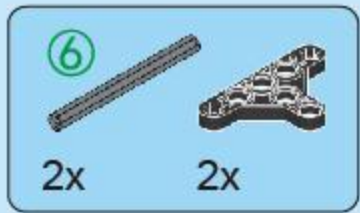
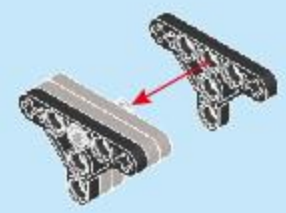

102

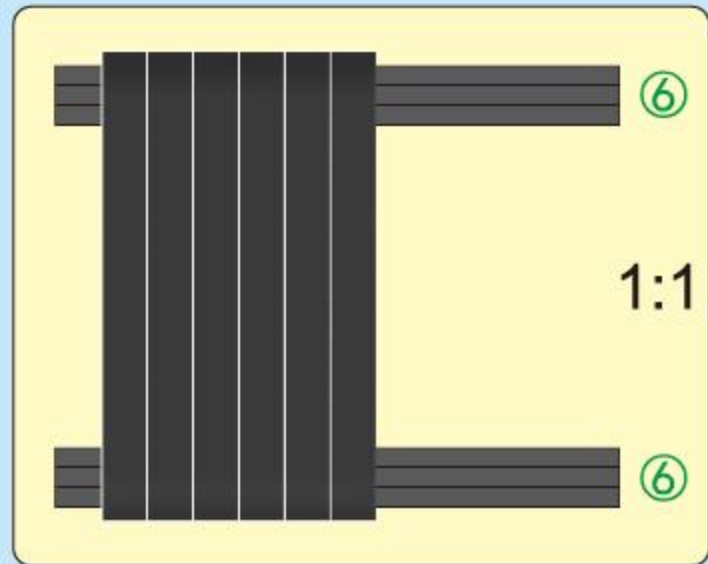
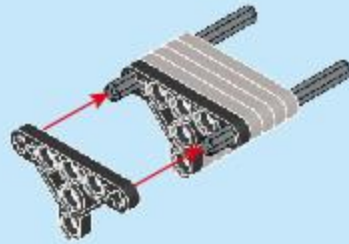



103

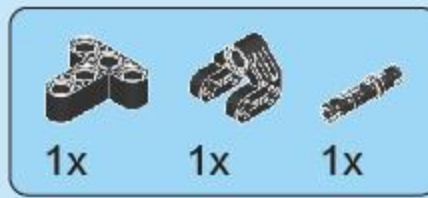
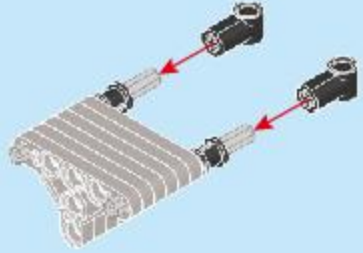

104

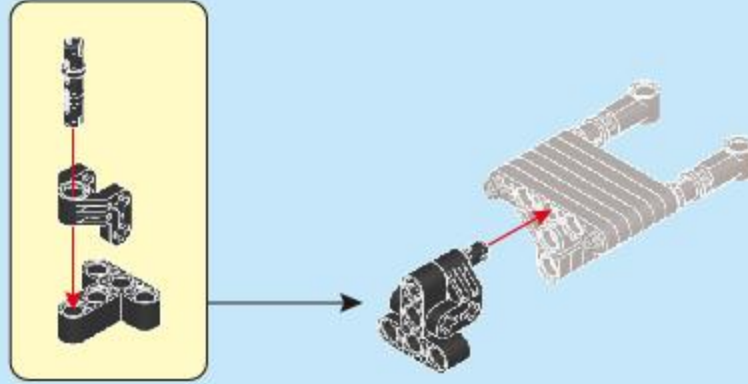

105

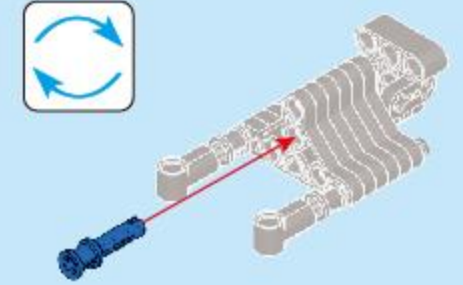

106

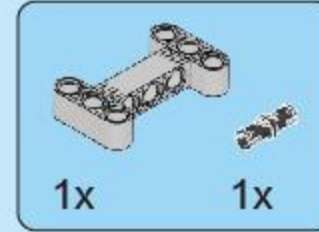
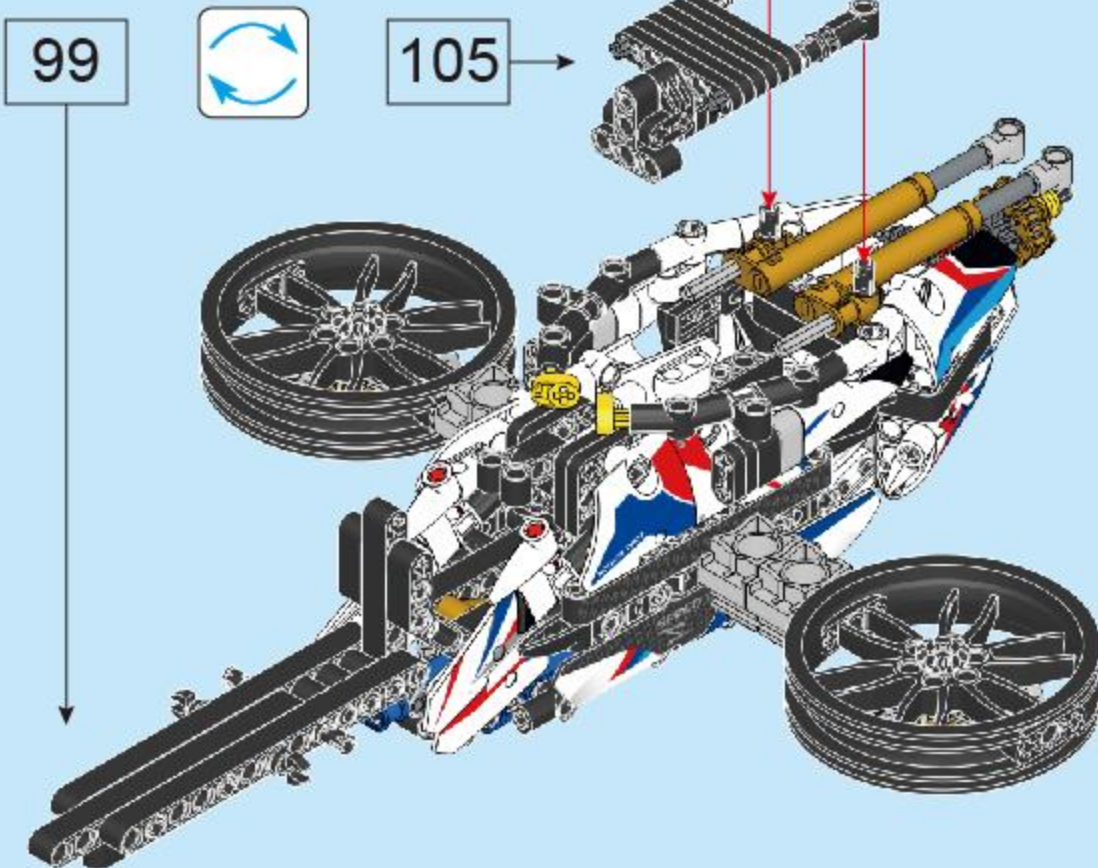

107

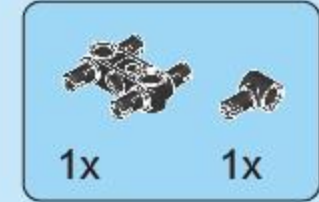
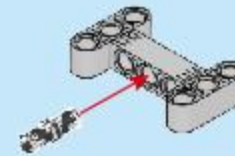

108



109

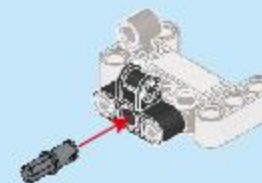

110

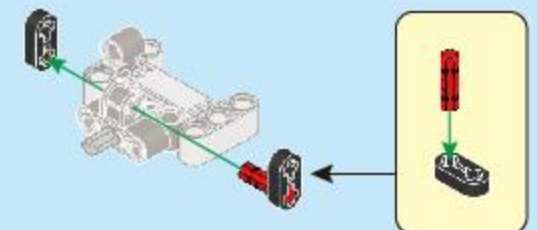

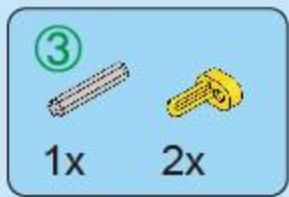

111

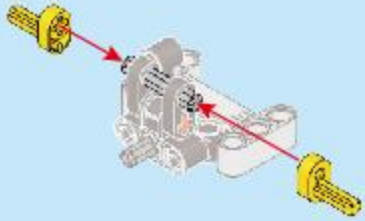

112

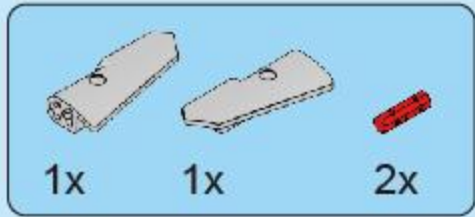
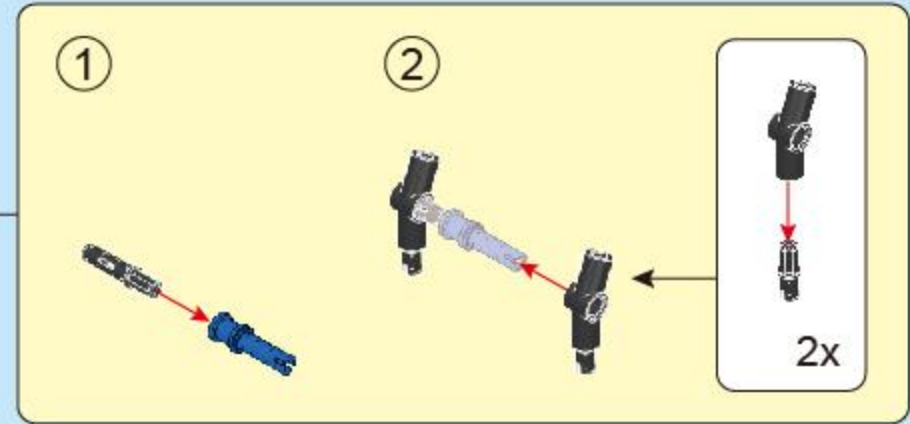
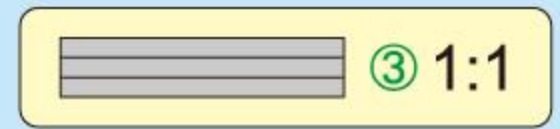
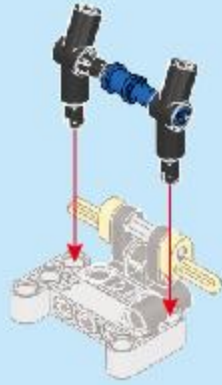

113

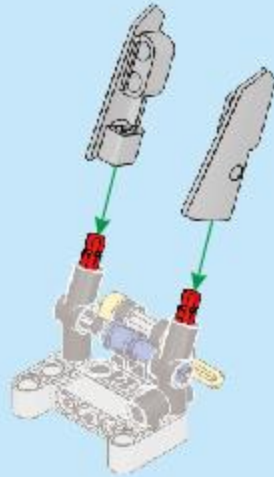

114

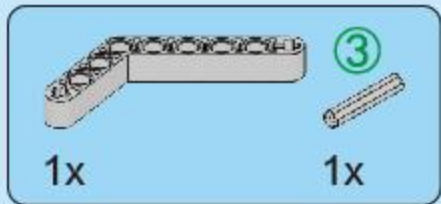
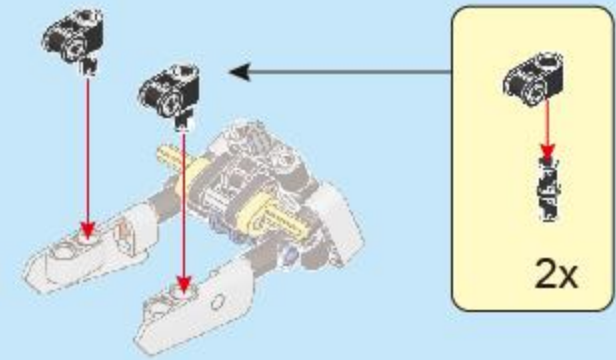

115

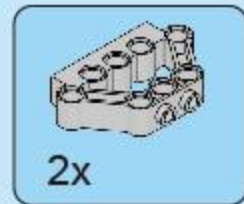
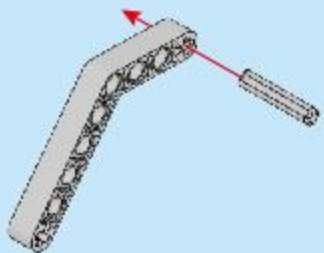

116

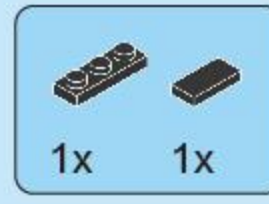
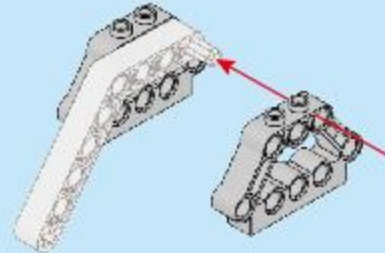

117

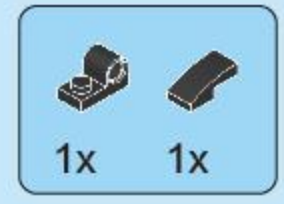
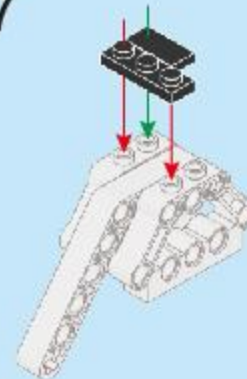

118

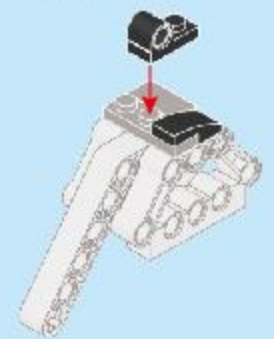



119

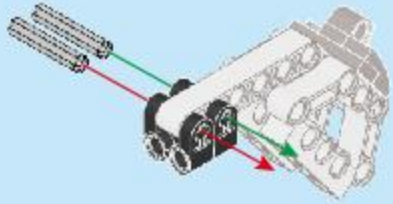

120



121

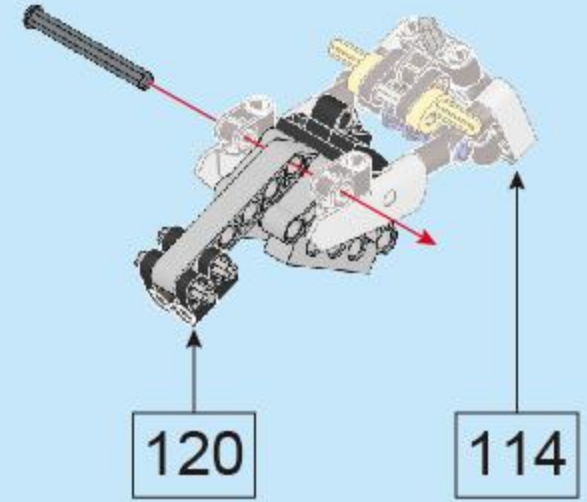

122

121



106

22

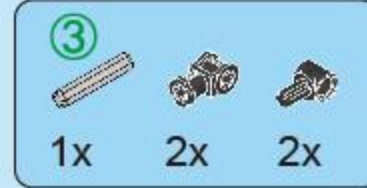
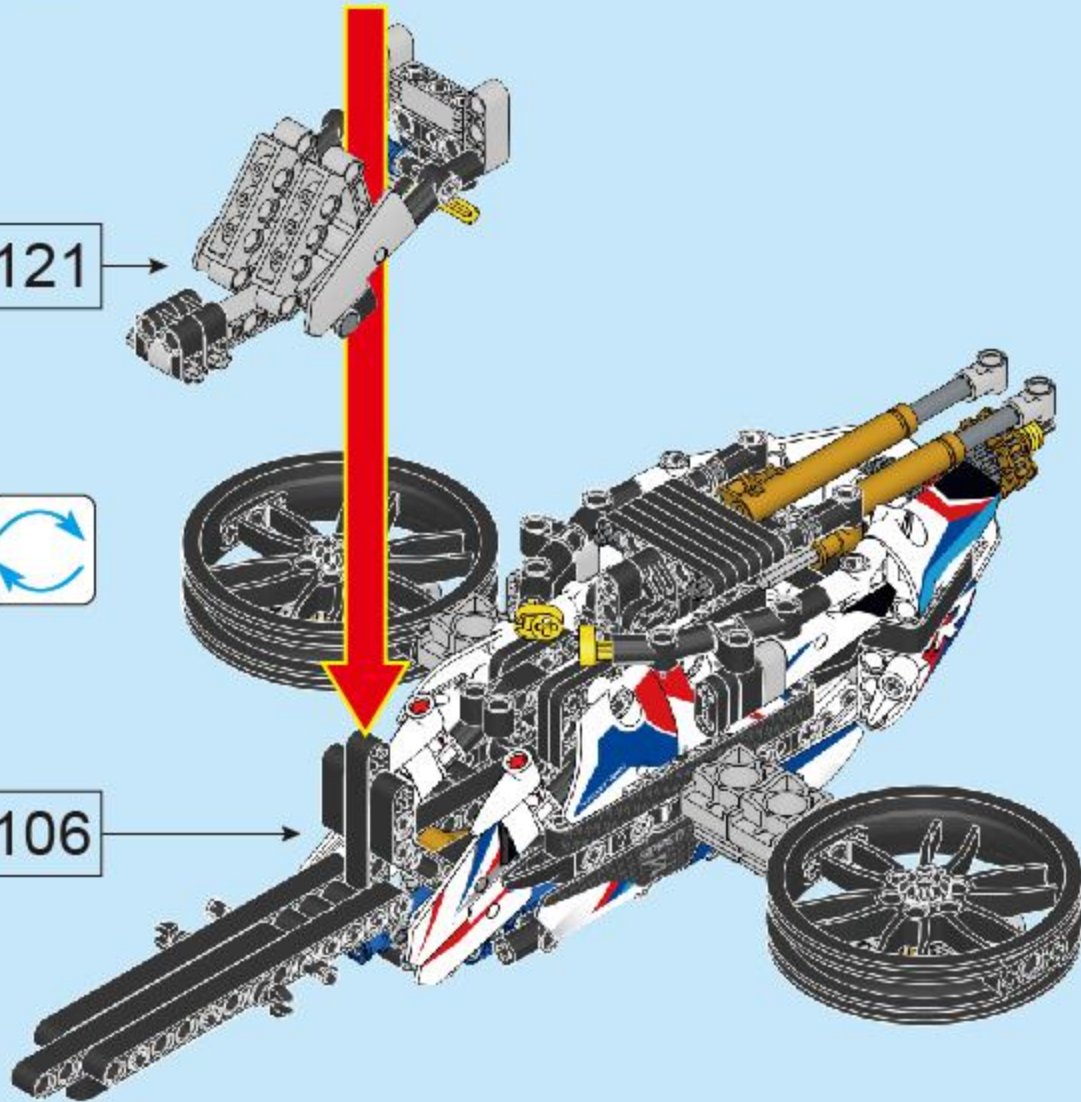

123

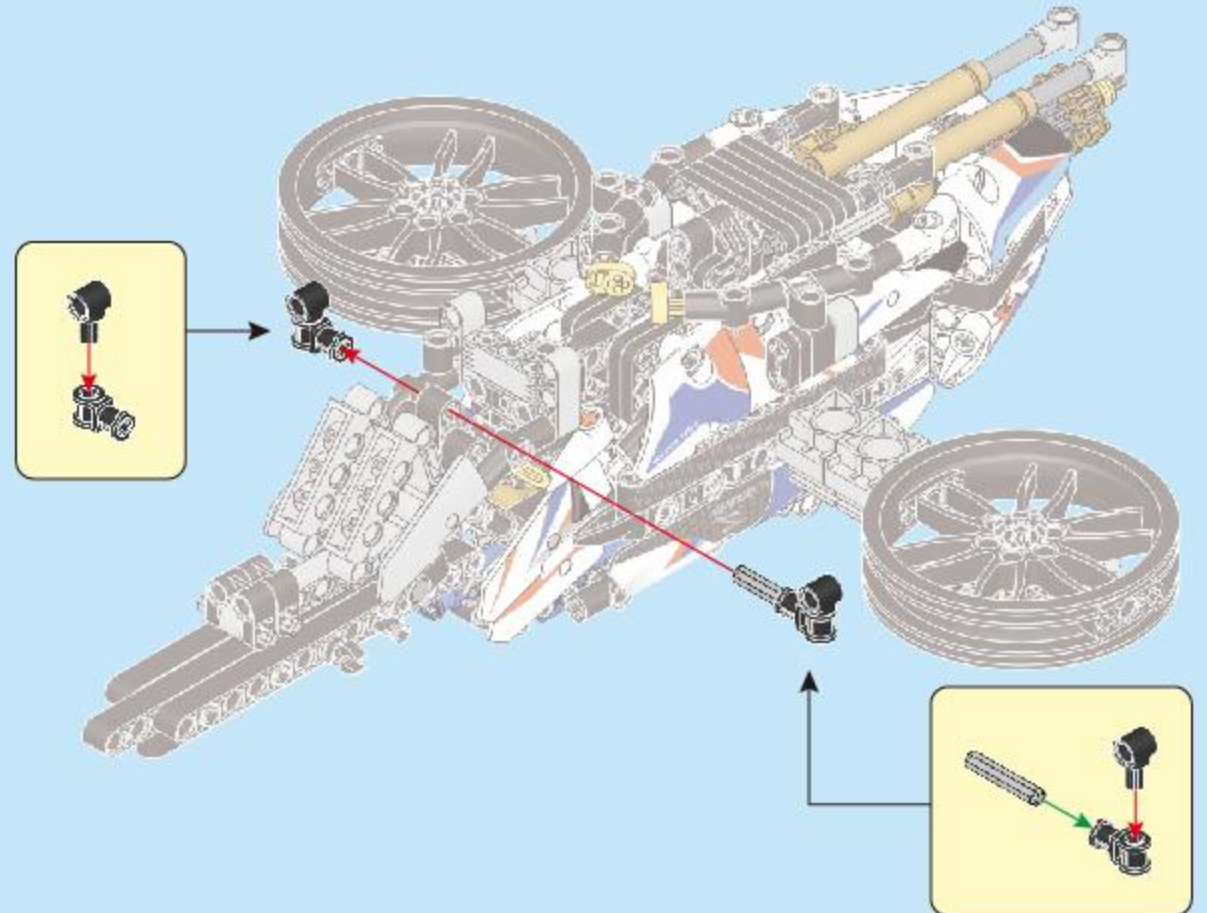

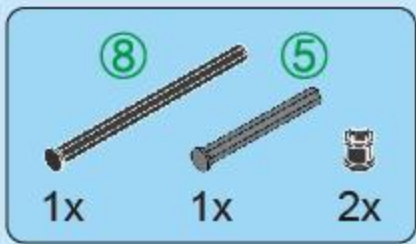

124

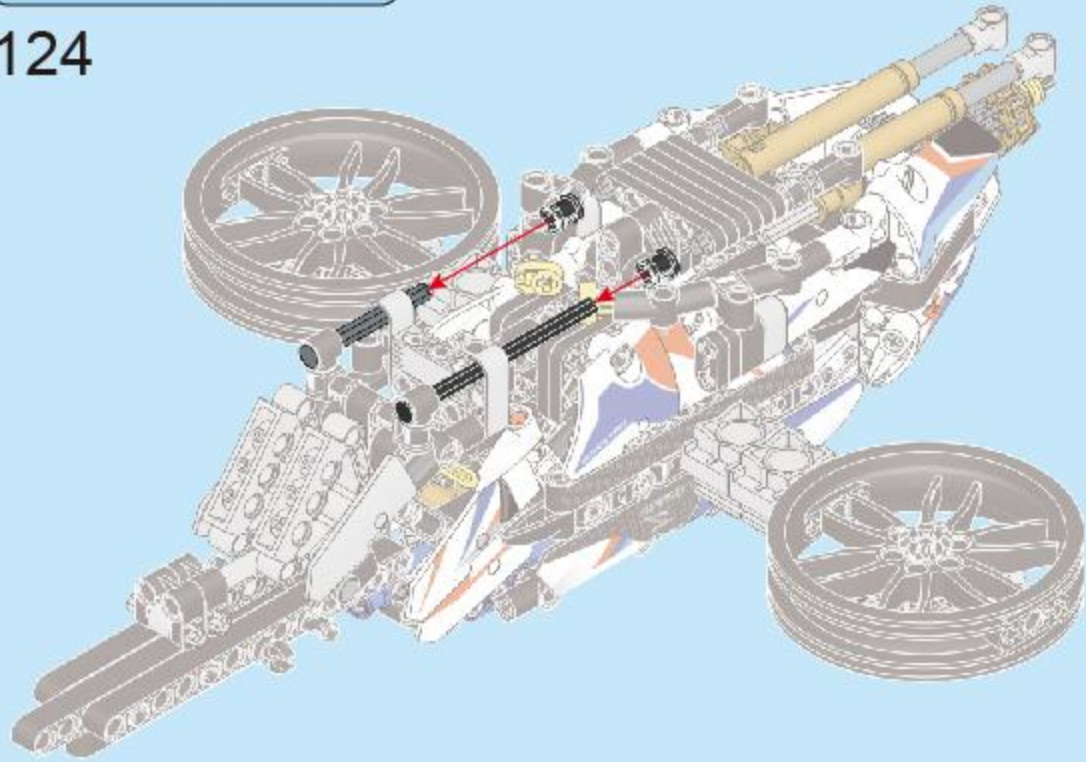

125



126

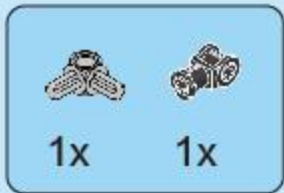
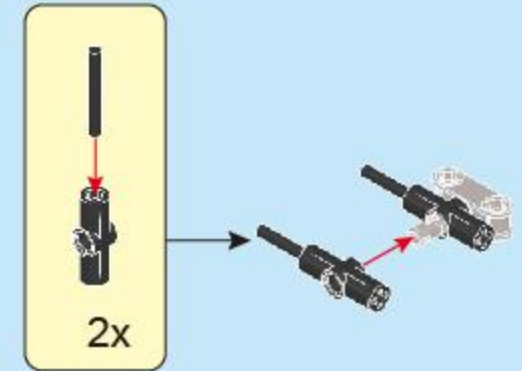

127

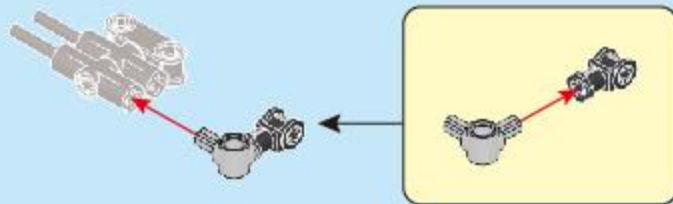

128



129

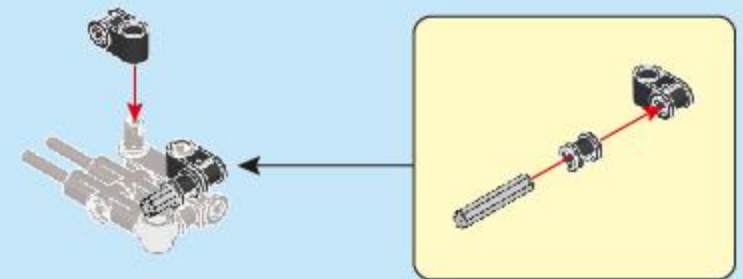

130

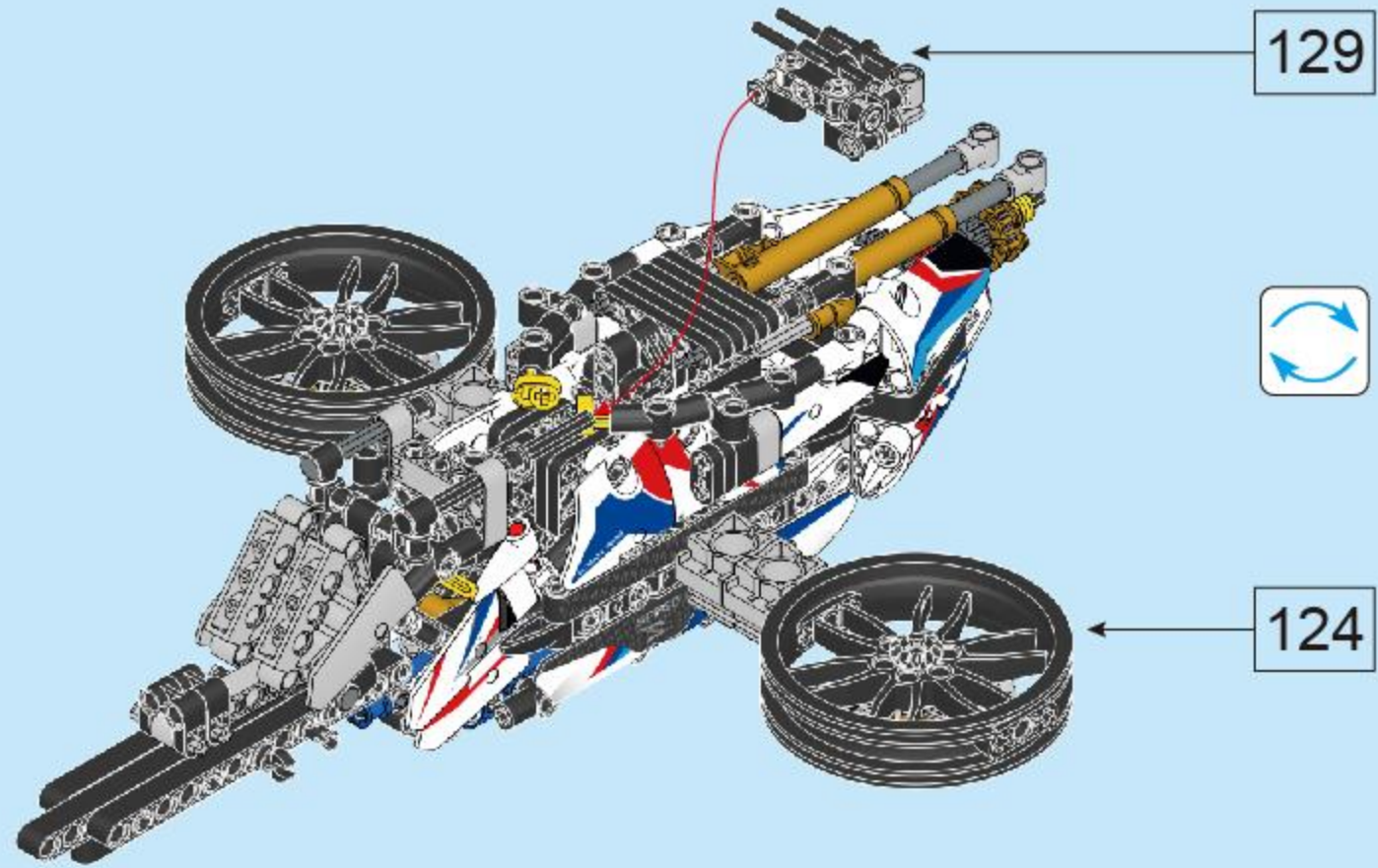

131

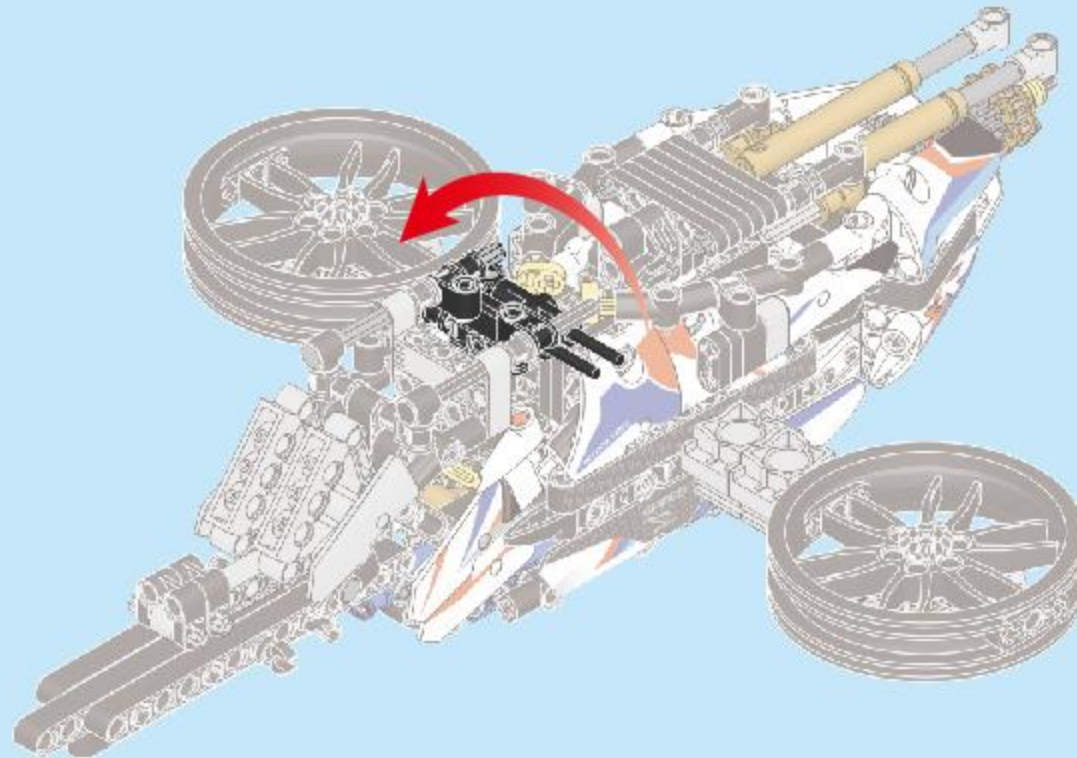





132

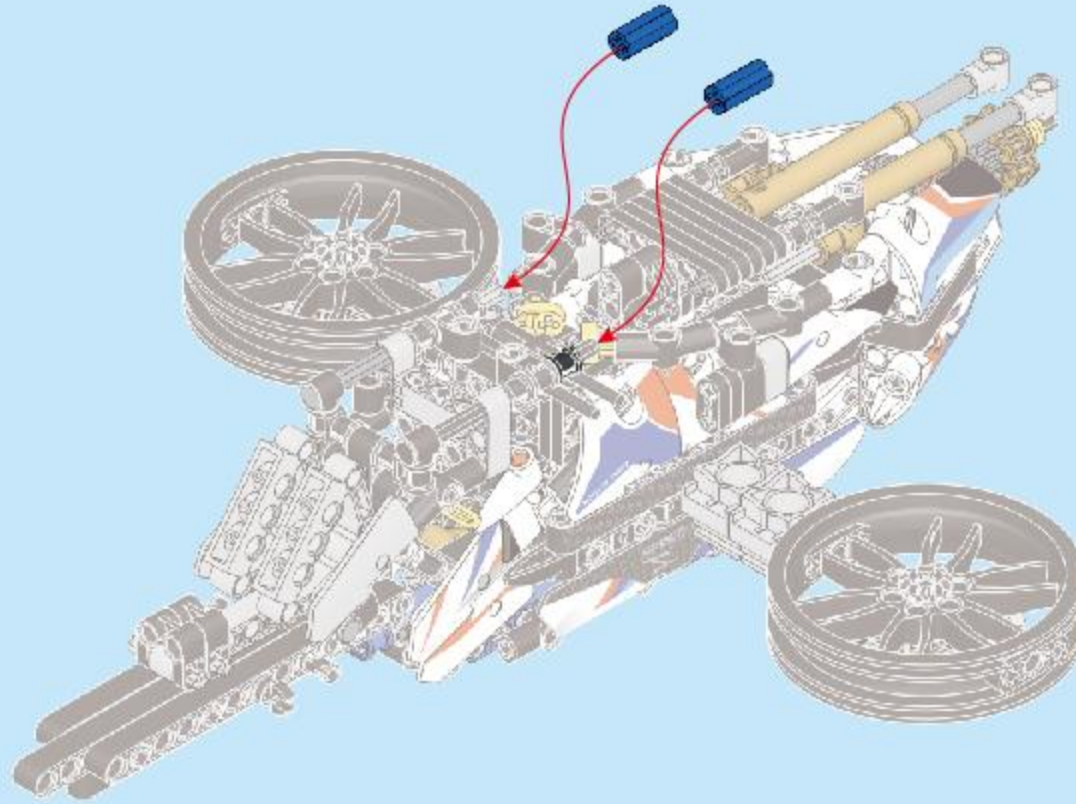

133

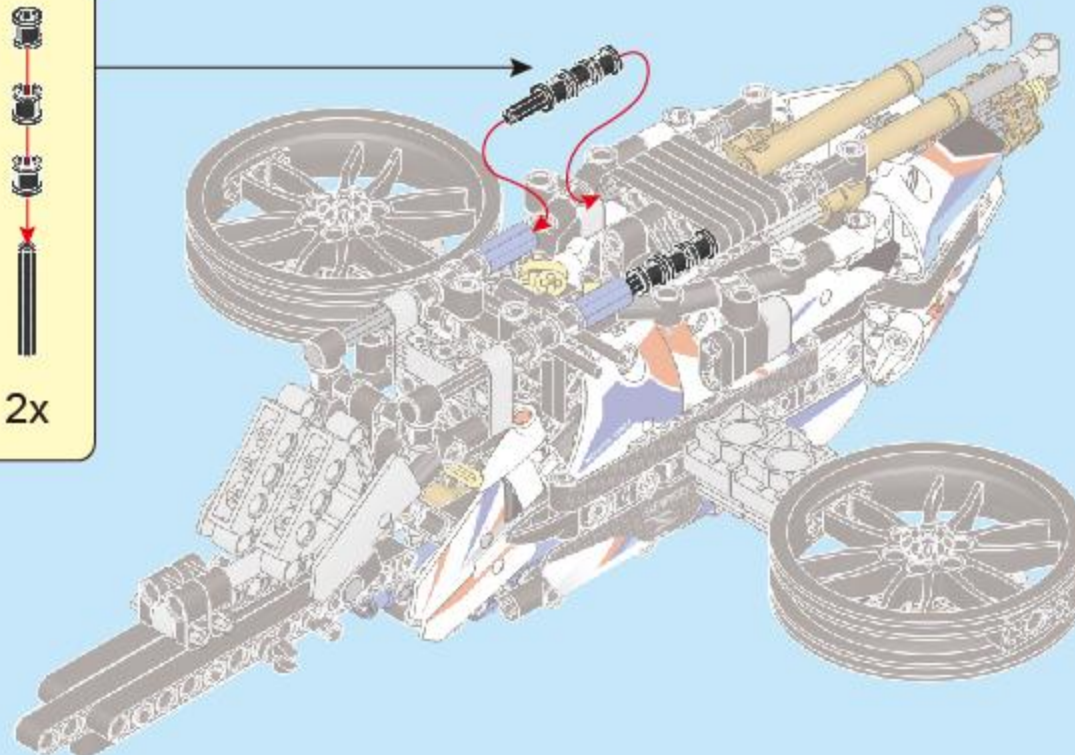
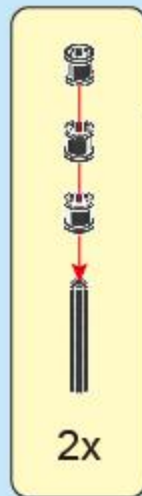

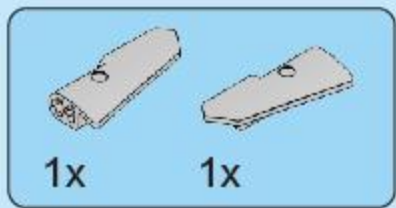

134

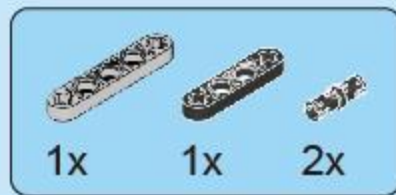

135

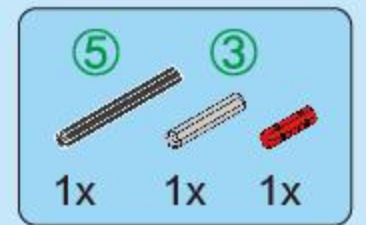

136

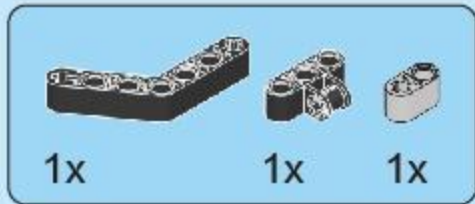
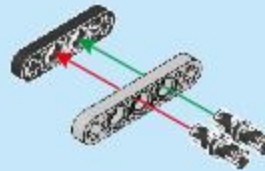
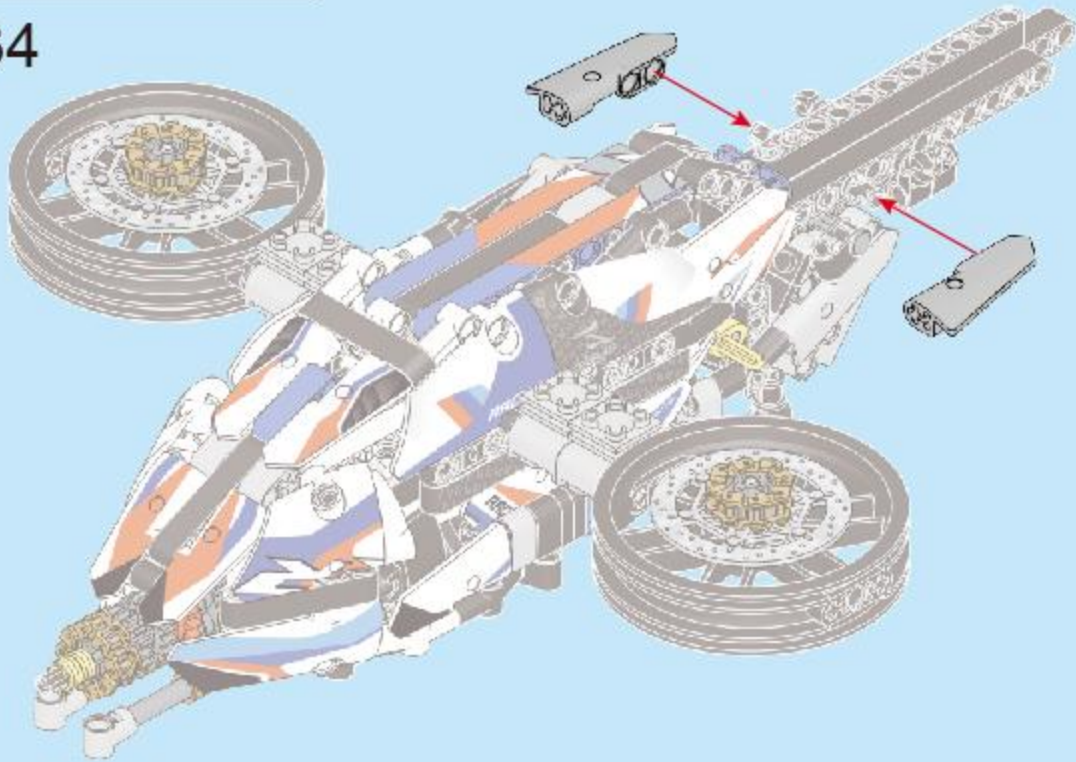

137

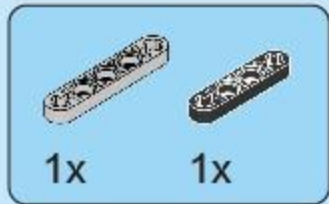

138



139

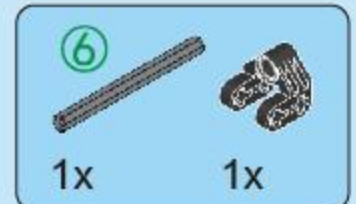

140

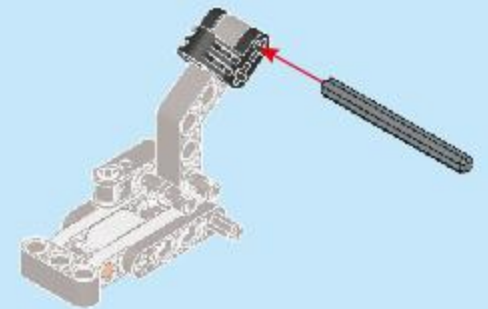
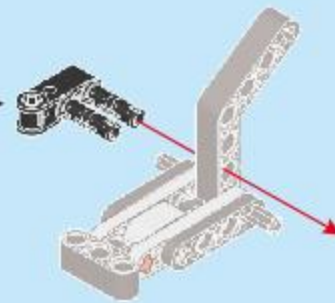
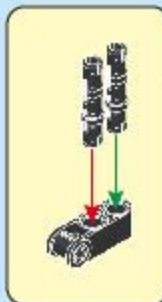
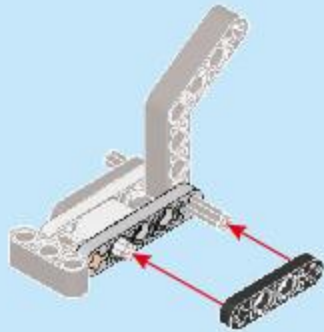
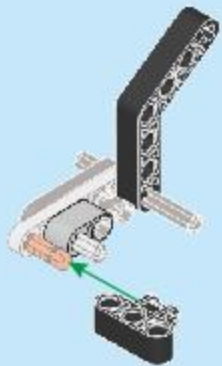

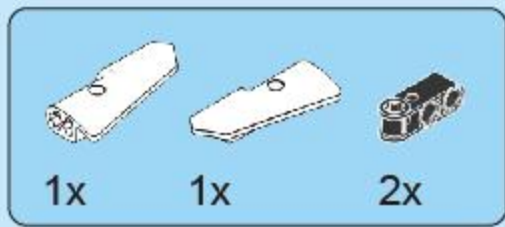

141

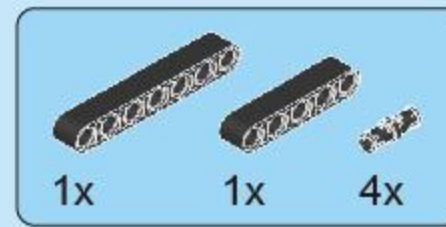
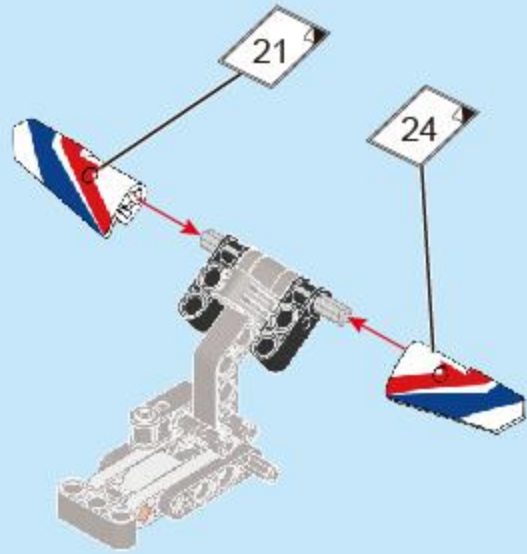

142

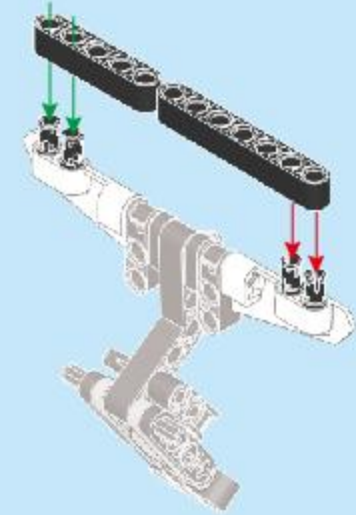

143

134



142

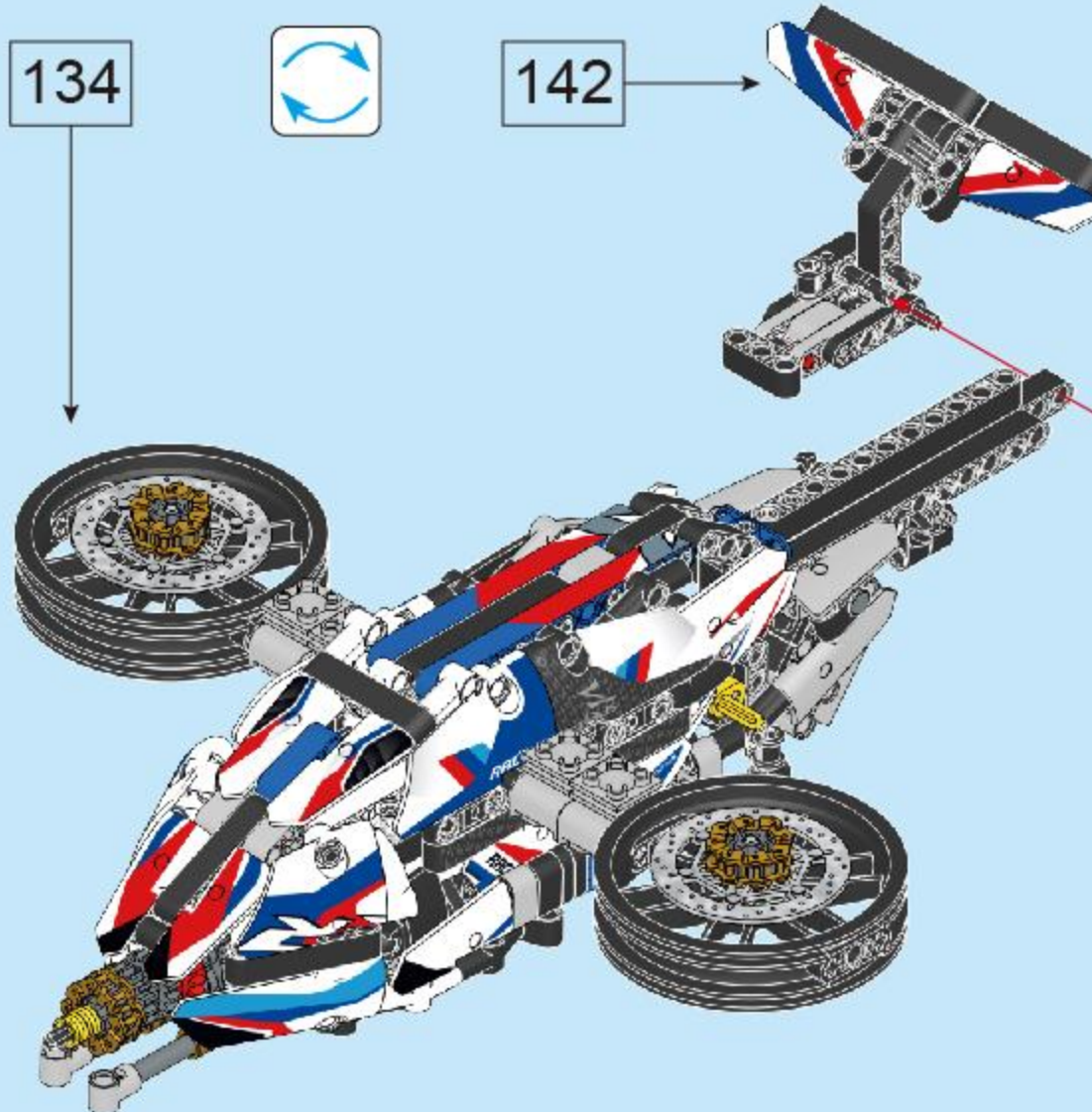



144

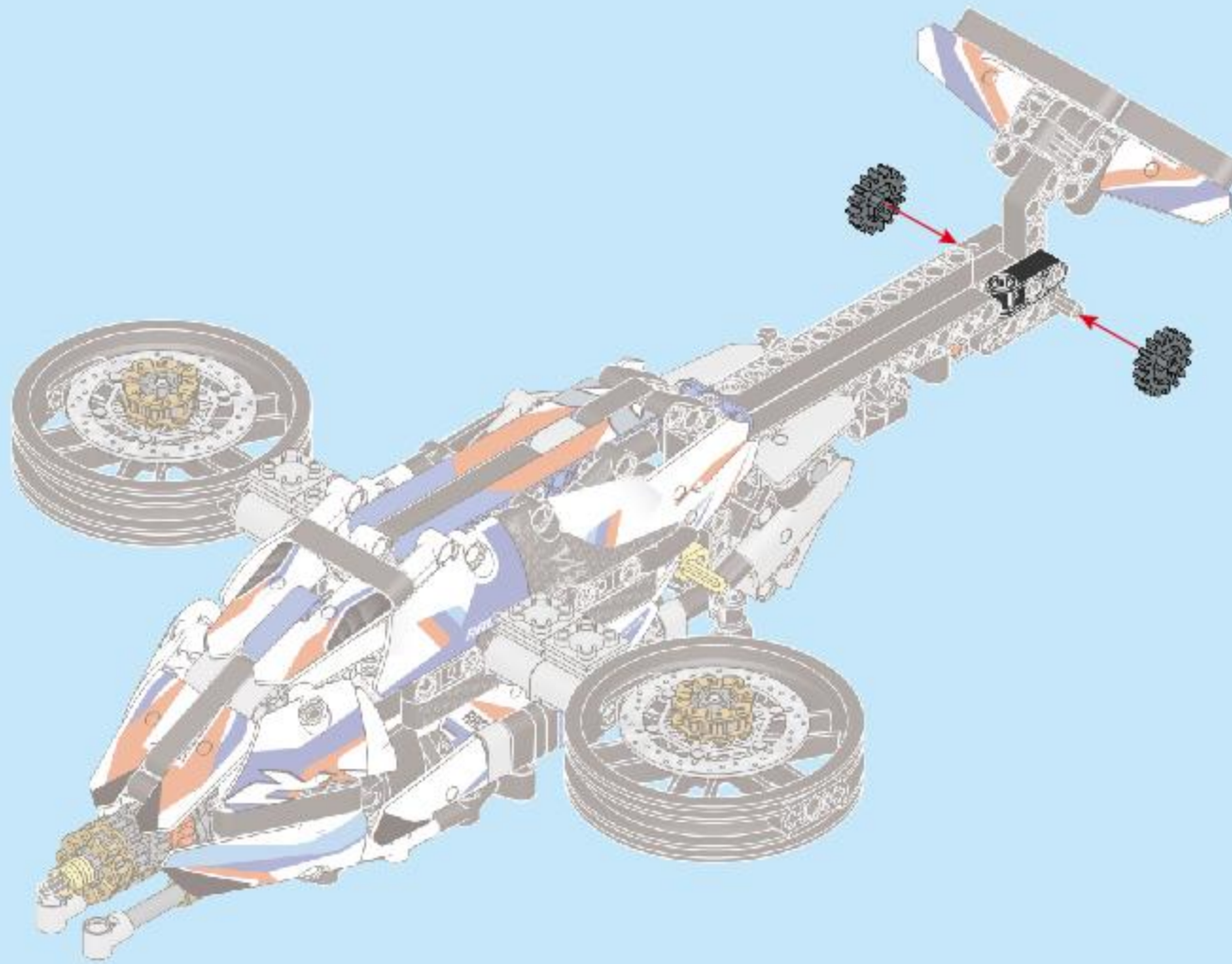

145

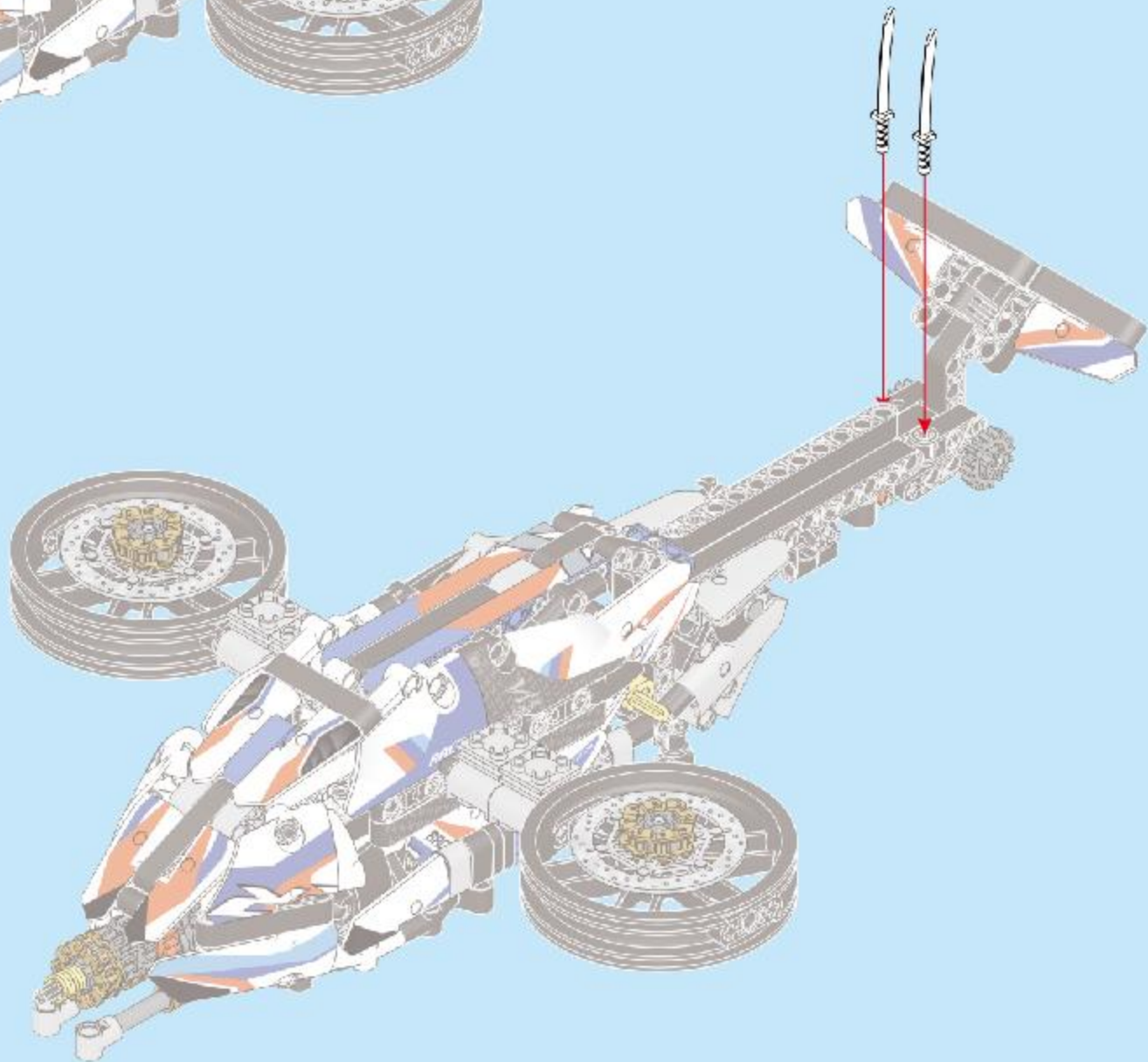



146

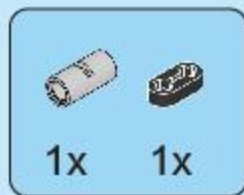

147



148

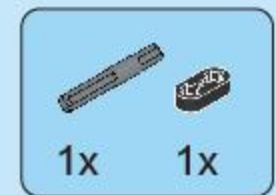

149

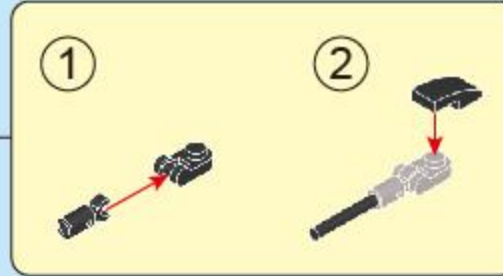

150

151

145

150

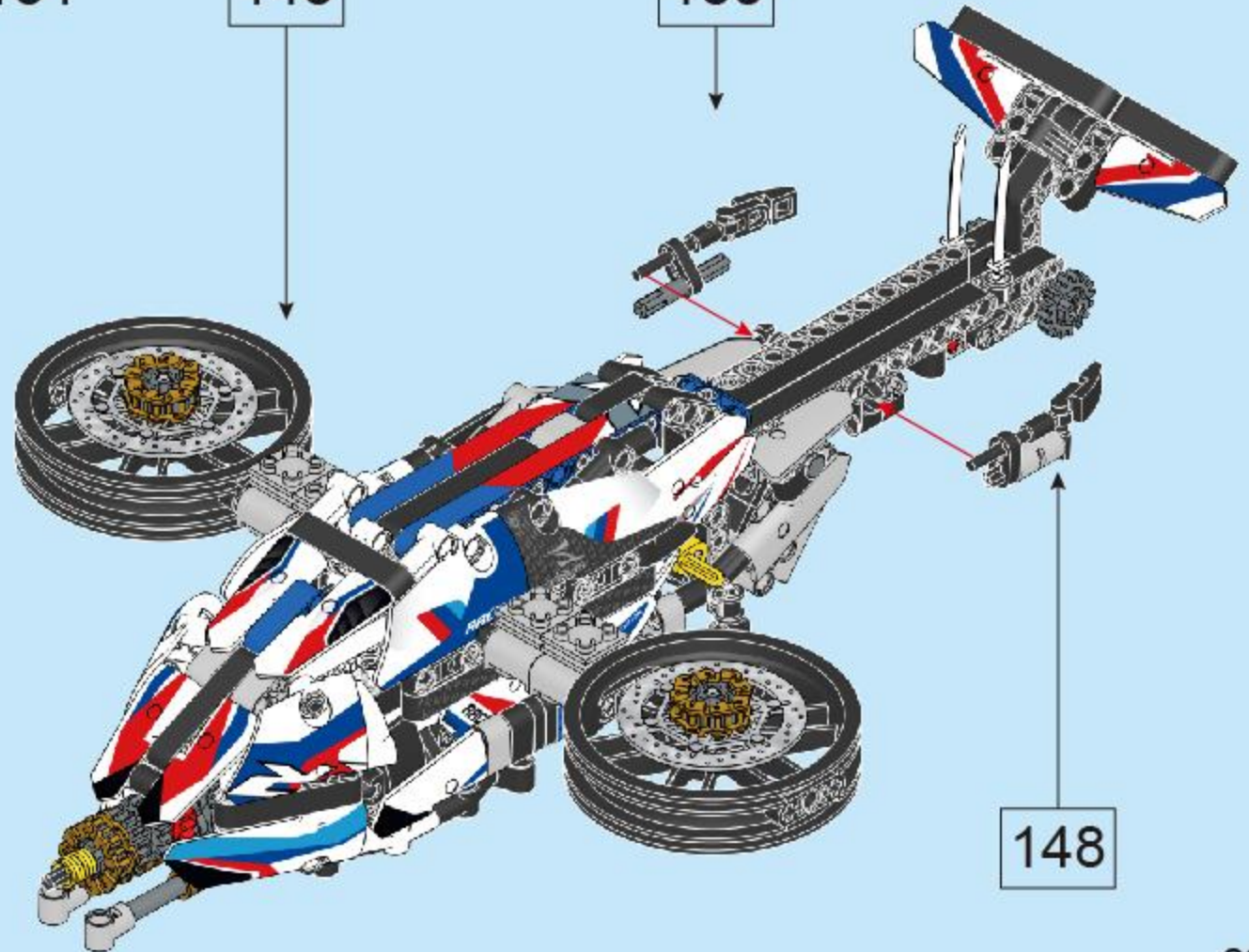
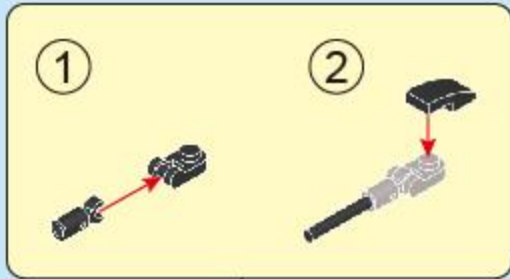

148

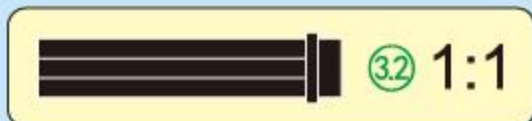



152

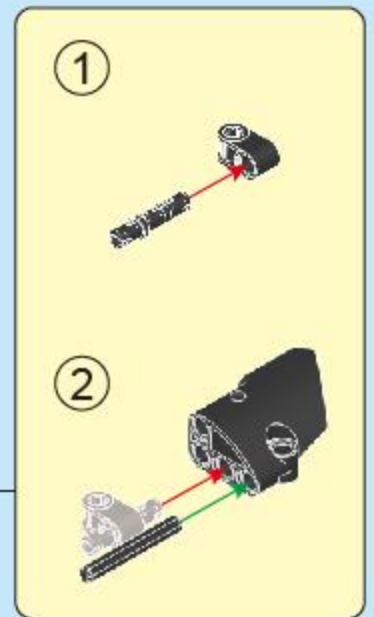
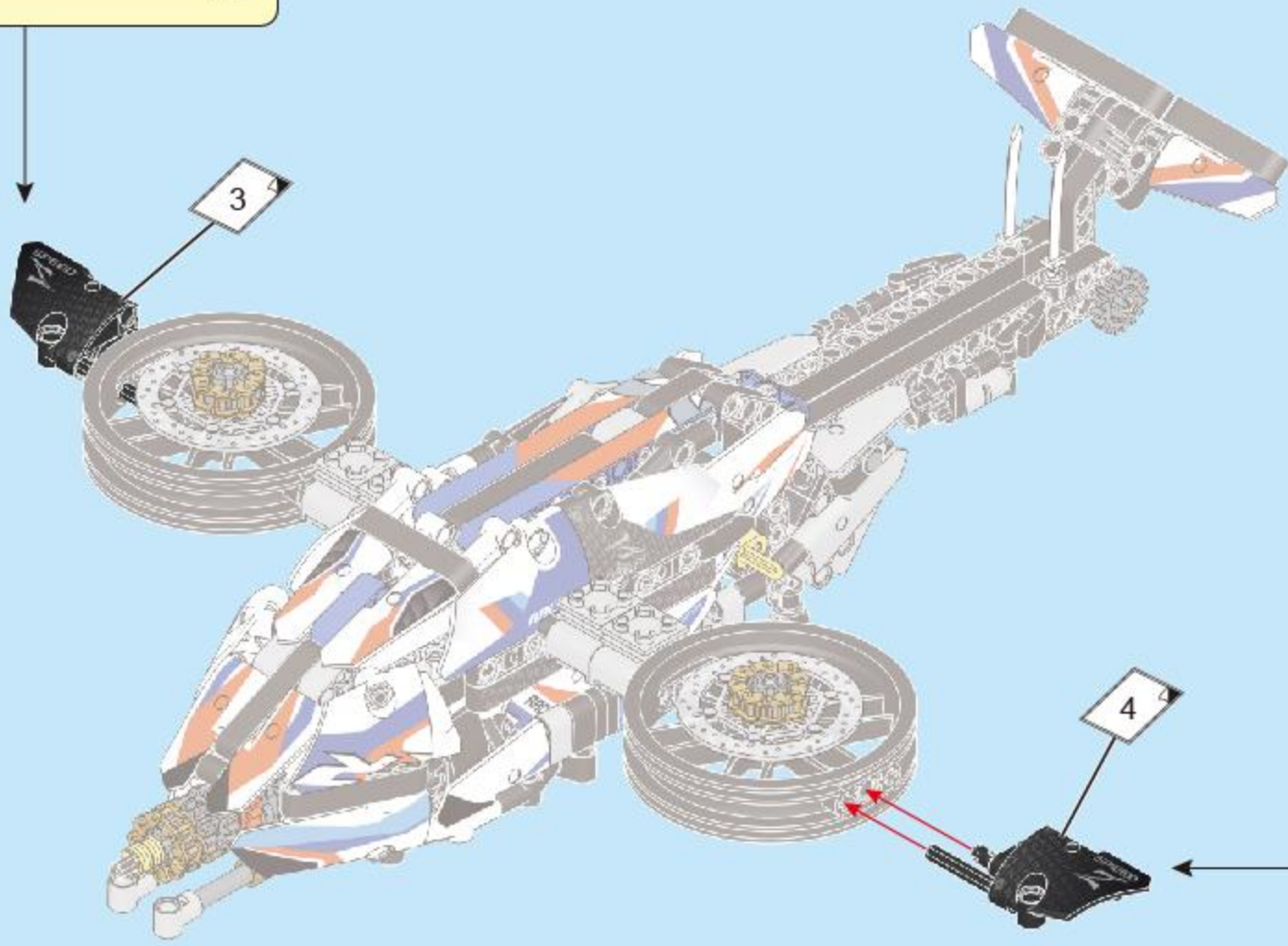
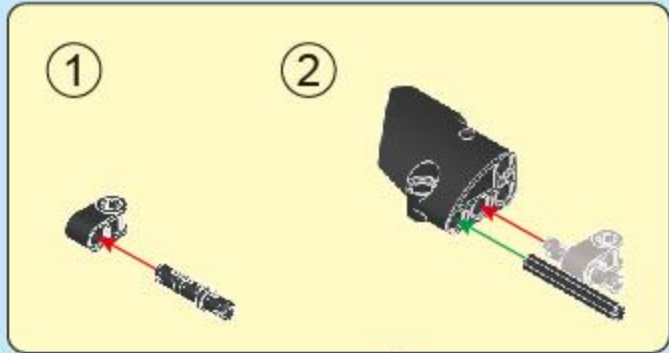

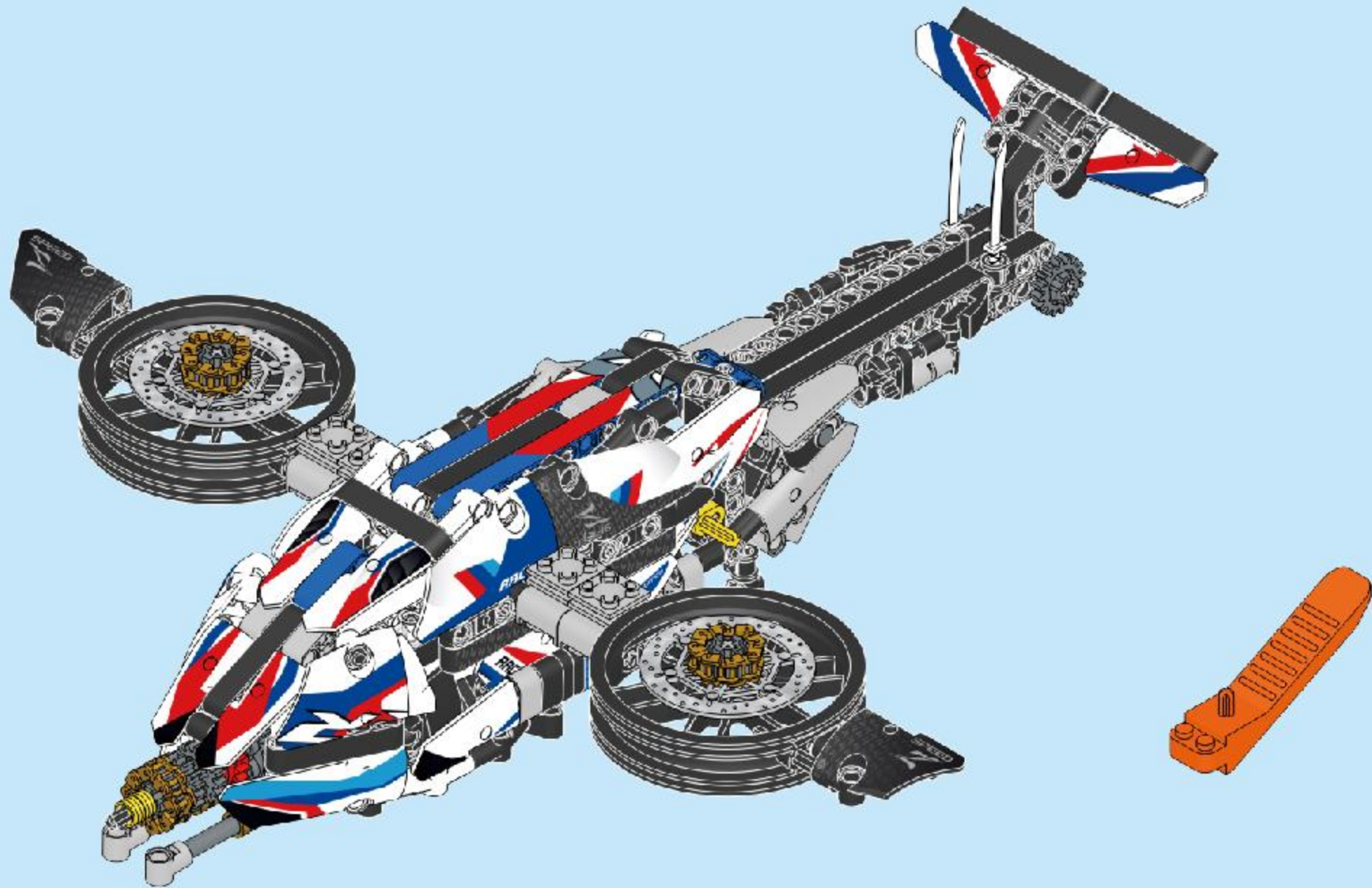

# ENGINE-MORPH



FORM 2

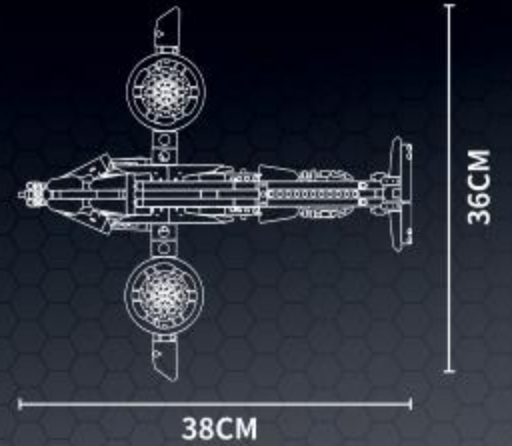

HEADSTOCK STEERING  
ABSORBER 车头转向减震杆



CYLINDER GEAR DRIVE  
汽缸齿轮传动

FORM 1

