

37 22 29 3 36 38 39 40 41

42 43 44 45 46 47 48

49 50 51 52 53 54 55 56 57 58 59

60 61 62 63 64 65 66

67 68 69 70 71 72

73 74 75 76 77 78 79 80 81

82 83 84 85 86

Detailed description of the assembly instructions:

- Step 37:** Assemble the top deck of the chassis using parts 22, 29, 3, and 36. Part 18 is also shown.
- Step 38:** Attach the motor and gear assembly to the chassis. Part 38 is the main sub-assembly.
- Step 39:** Attach a small gear assembly (1x, 2x).
- Step 40:** Attach another gear assembly (1x, 1x).
- Step 41:** Attach a third gear assembly (1x, 1x, 1x).
- Step 42:** Attach a red plate (1x, 2x).
- Step 43:** Attach blue and red pins (2x, 2x).
- Step 44:** Attach various grey and white pins (1x, 1x, 1x, 2x).
- Step 45:** Attach a red plate and grey pins (1x, 3x).
- Step 46:** Attach blue and grey pins (1x, 1x).
- Step 47:** Attach grey pins and a blue pin (1x, 1x, 1x).
- Step 48:** Attach grey pins and a blue pin (1x, 2x, 1x).
- Step 49:** Attach grey pins (3x, 1x).
- Step 50:** Attach grey pins (1x, 1x, 1x).
- Step 51:** Attach a grey pin and a black pin (1x, 1x).
- Step 52:** Attach the motor assembly to the chassis. Parts 45, 51, 4, and 5 are indicated.
- Step 53:** Attach the robot's head and neck assembly. Part 53 is the main sub-assembly.
- Step 54:** Attach a grey box (1x).
- Step 55:** Attach grey pins (2x, 1x).
- Step 56:** Attach a red plate and grey pins (1x, 1x, 1x).
- Step 57:** Attach a red plate and a grey pin (2x, 2x).
- Step 58:** Attach a grey pin and a black pin (1x, 1x).
- Step 59:** Attach grey pins (2x, 2x).
- Step 60:** Attach grey pins (1x, 2x).
- Step 61:** Attach blue and grey pins (1x, 1x, 2x).
- Step 62:** Attach grey pins (1x, 1x, 1x).
- Step 63:** Attach grey pins (1x, 1x, 1x, 1x).
- Step 64:** Attach blue and grey pins (1x, 1x, 1x, 1x).
- Step 65:** Attach grey pins (1x, 2x).
- Step 66:** Attach blue and grey pins (1x, 1x, 2x).
- Step 67:** Attach grey pins (1x, 1x, 1x).
- Step 68:** Attach grey pins (1x, 1x, 1x, 1x).
- Step 69:** Attach blue and grey pins (1x, 1x, 1x, 1x).
- Step 70:** Attach the robot's arm assembly. Parts 59, 64, 16, and 69 are indicated.
- Step 71:** Attach grey pins (1x, 1x).
- Step 72:** Attach a red plate (2x).
- Step 73:** Attach red and grey pins (2x, 2x).
- Step 74:** Attach grey pins (2x, 1x, 1x).
- Step 75:** Attach grey pins (2x, 2x, 2x).
- Step 76:** Attach a grey pin (2x).
- Step 77:** Attach grey pins (1x, 1x, 1x, 1x).
- Step 78:** Attach blue and grey pins (1x, 1x).
- Step 79:** Attach blue and grey pins (2x, 1x).
- Step 80:** Attach a grey pin (1x).
- Step 81:** Attach grey pins (2x, 4x).
- Step 82:** Attach grey pins (2x, 2x).
- Step 83:** Attach grey pins (2x, 2x, 2x).
- Step 84:** Attach grey pins (2x, 2x, 2x).
- Step 85:** Attach the robot's leg assembly. Parts 80 and 70 are indicated.
- Step 86:** Attach the robot's arm assembly. Parts 84, 15, 85, and 17 are indicated.

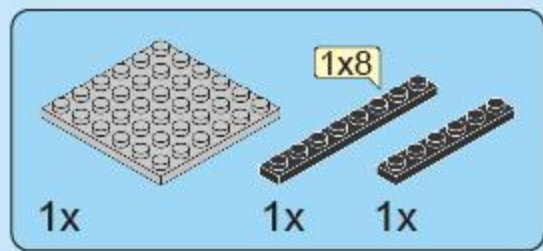

1

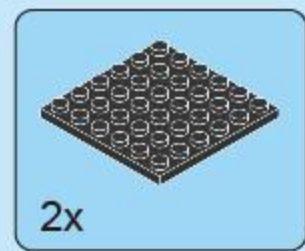
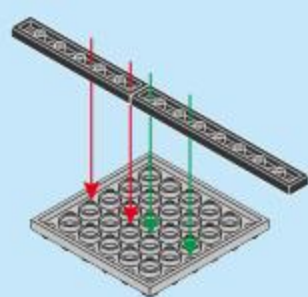

2

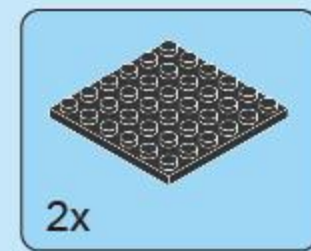
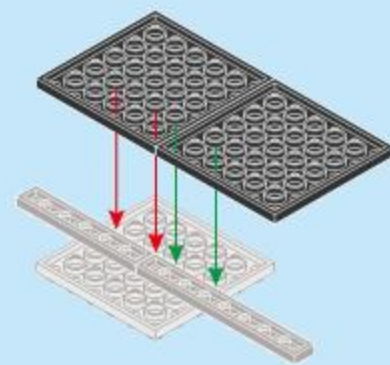

3

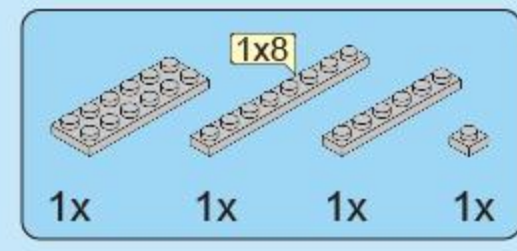
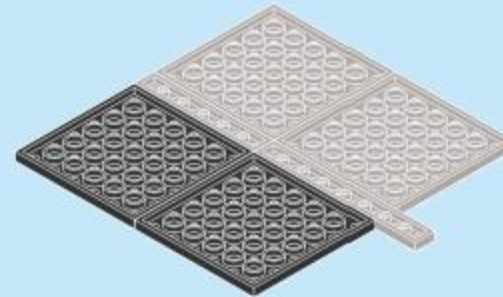

4

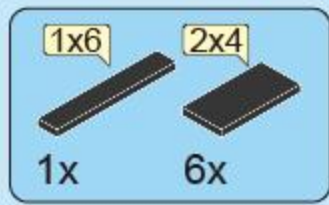
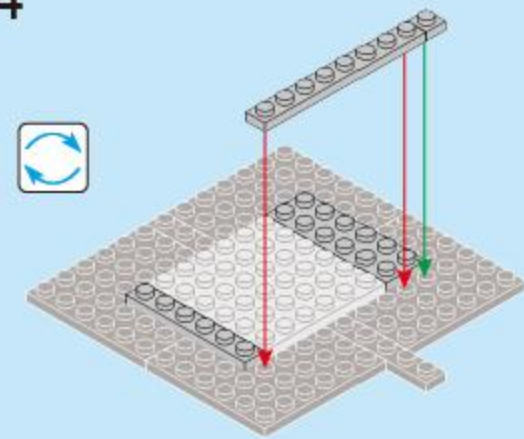

5

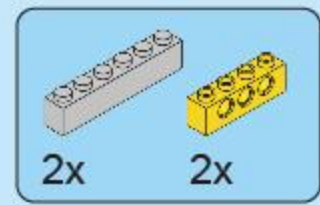
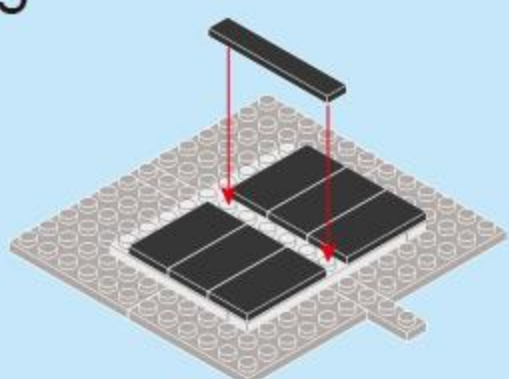

6

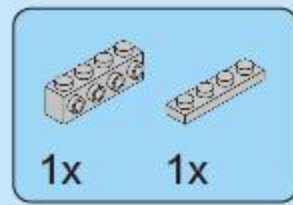
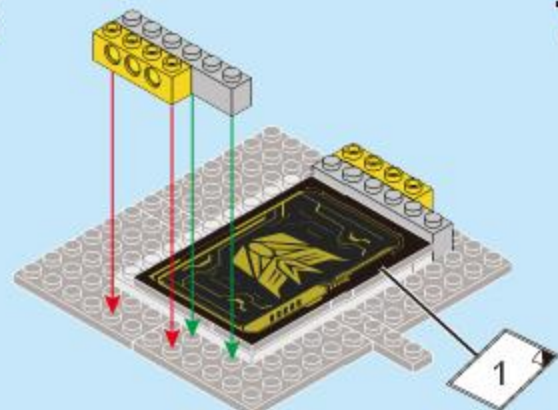

7

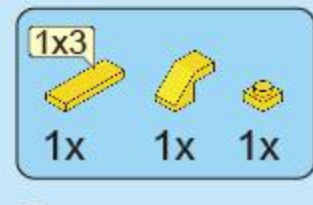
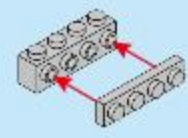

8

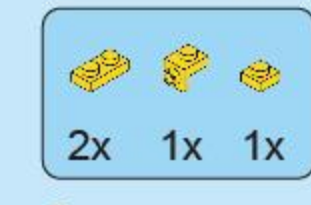
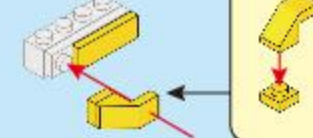

9

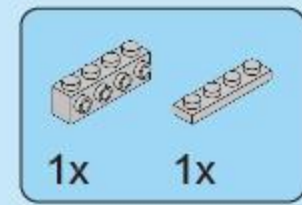
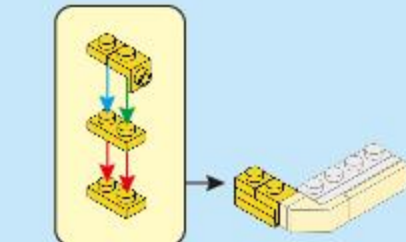

10

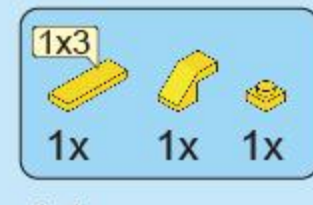
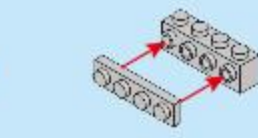

11

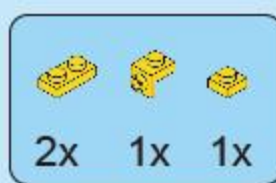
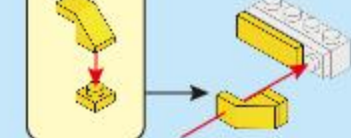

12

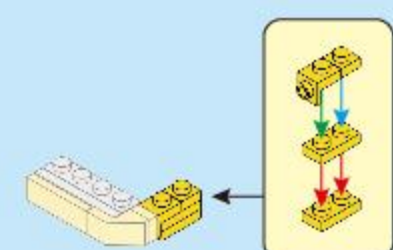

13

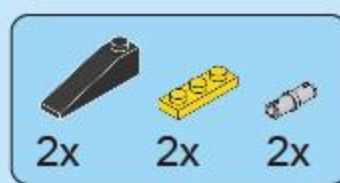
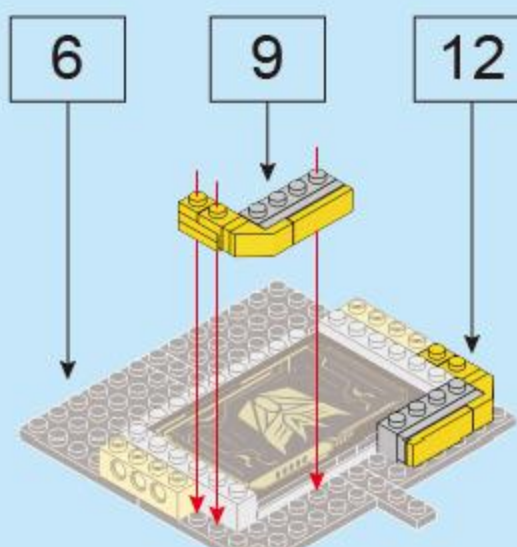

14

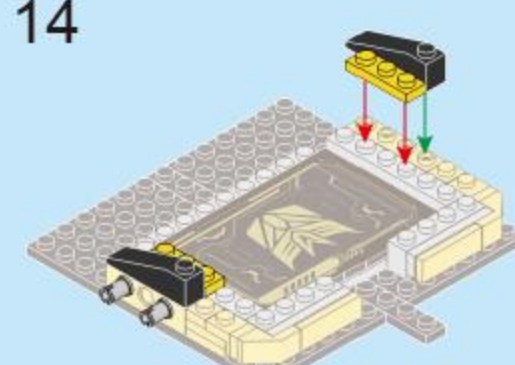

15

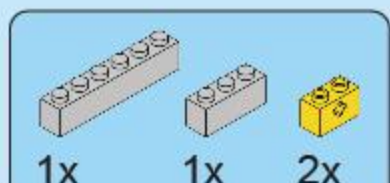
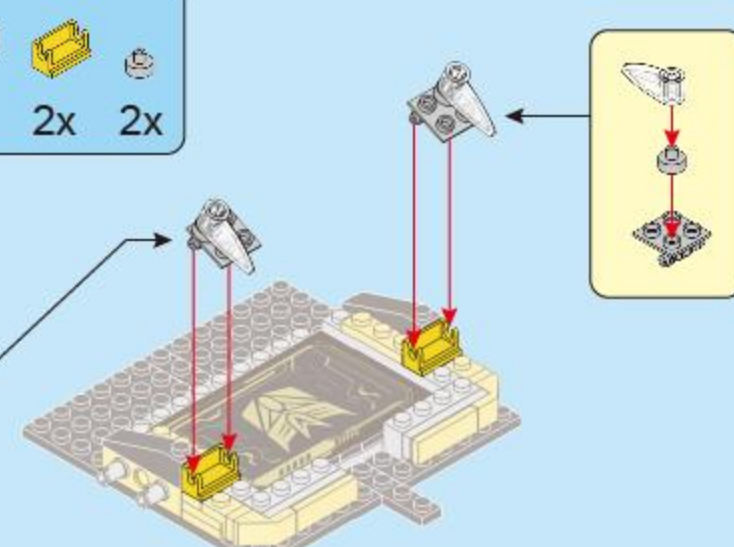
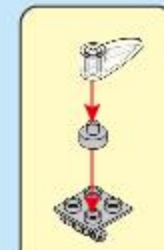

16

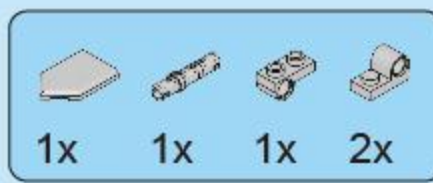
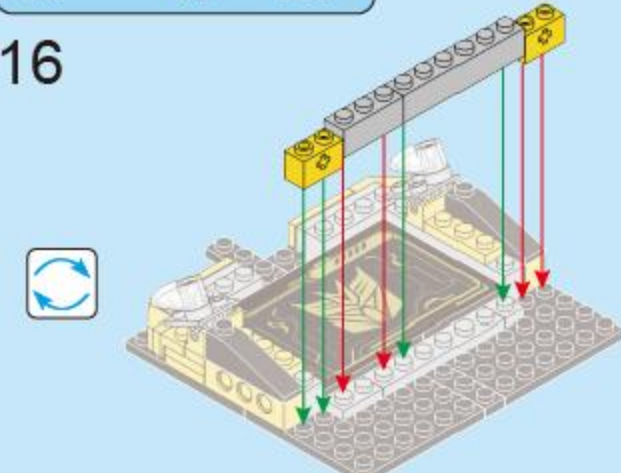

17

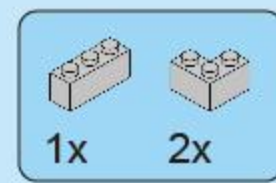
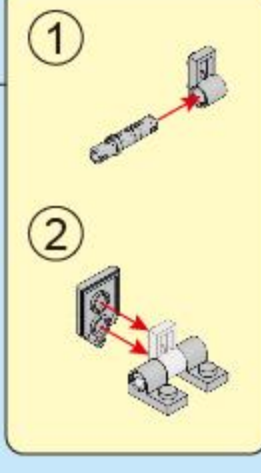
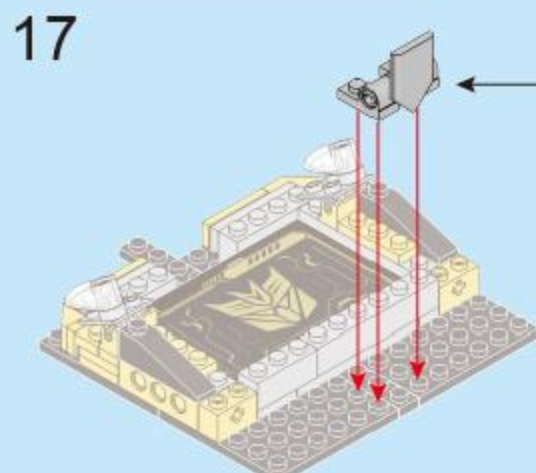

18

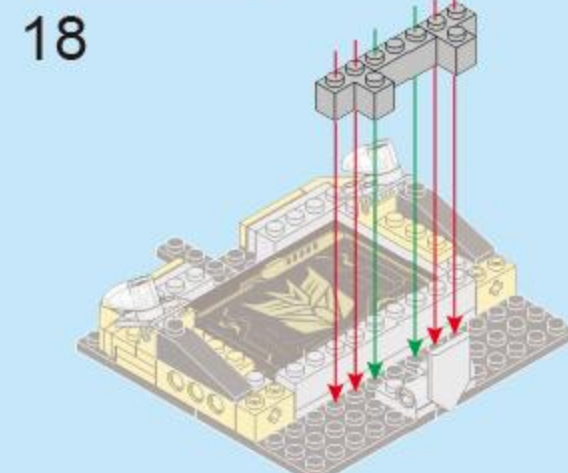

19

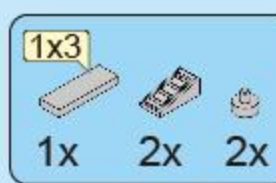
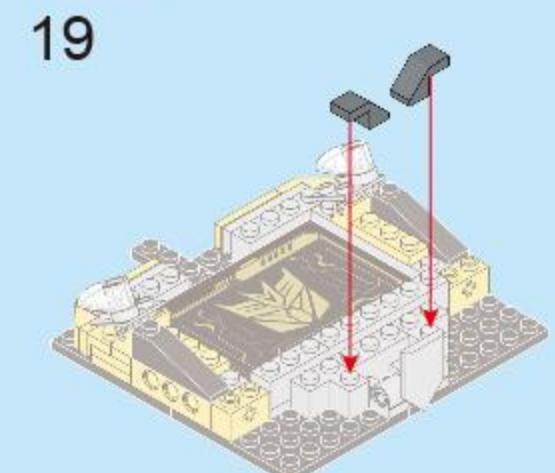

20

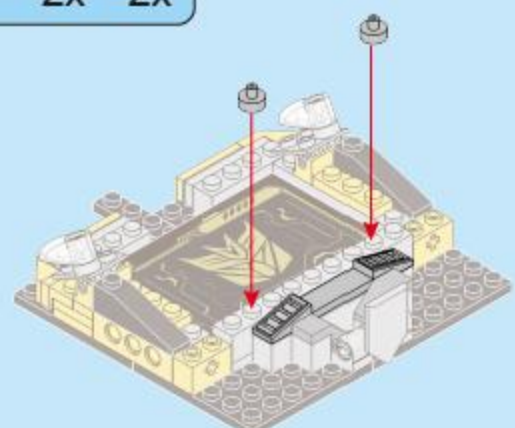

21

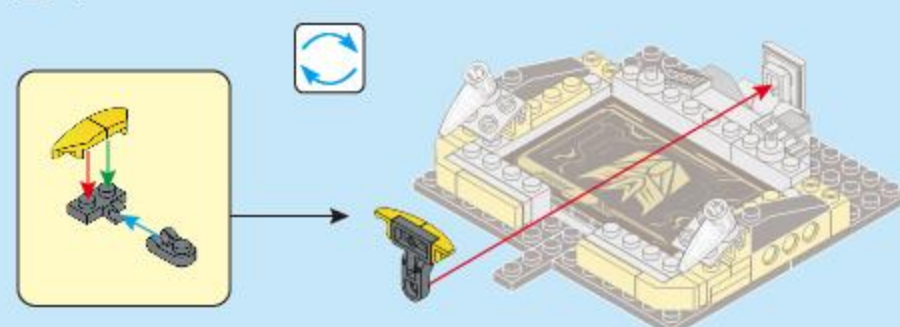

22

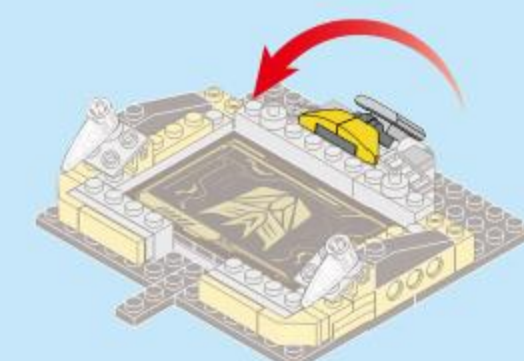

23

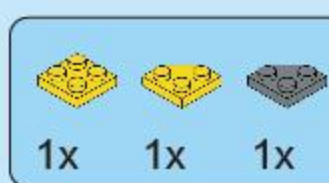
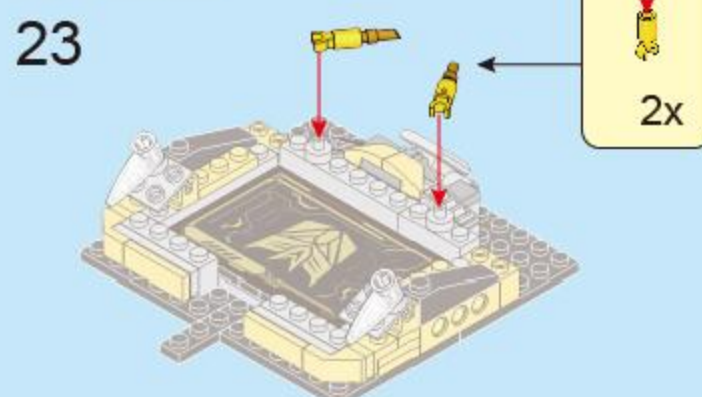

24

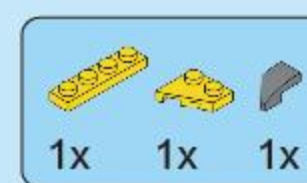
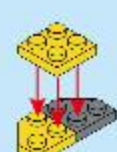

25

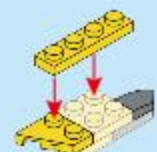

26



27

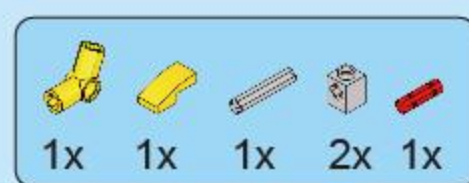

28

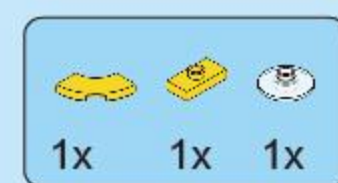
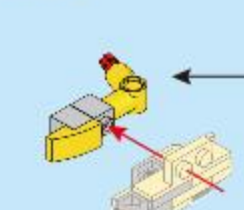

29

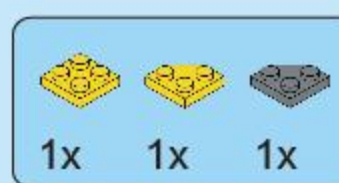
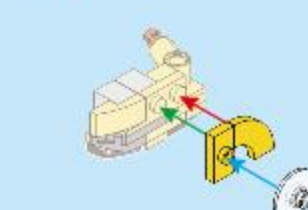

30

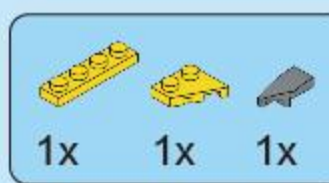

31

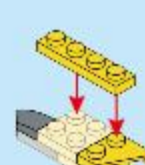

32

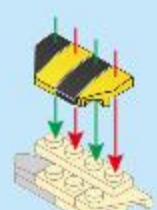

33

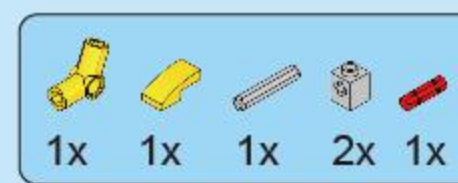
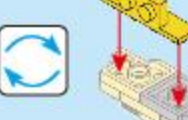

34

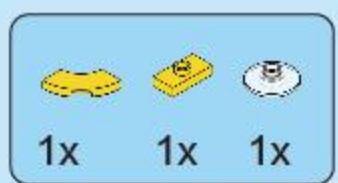
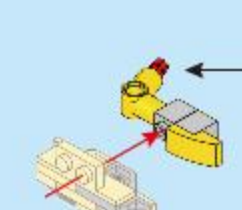

35

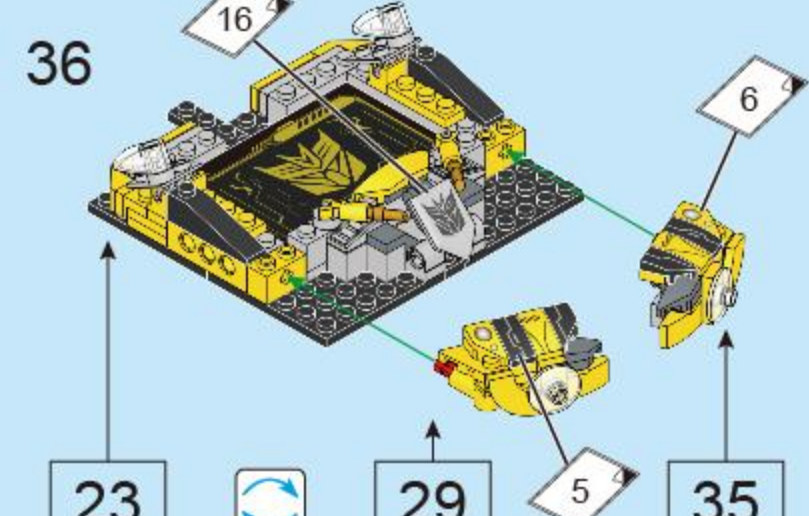
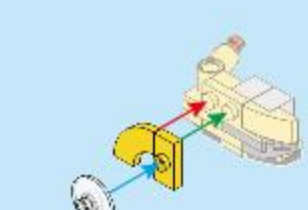

36

37 1x 1x 1x 1x

38 1x 1x 1x 1x

39 2x 2x

40 1x 2x

41 1x 1x

42 1x 1x 1x

43 2x3 1x 2x

44 1x 1x 1x

45 1x 1x 1x

46 1x 1x 1x 2x

47 2x3 1x 3x

48 1x 1x 1x

49 1x 4x

50 3x

51 2 3 50 47 39

52 1x

53 2x 1x

54 1x 1x 1x

55 2x 1x 2x

56 1x 1x

57 2x 2x

58 1x 2x

59 1x 1x 2x

60 1x 1x 1x

61 1x 1x 1x 1x

62 1x 1x 1x 1x

63 1x 2x

64 1x 1x 2x

65 1x 1x 1x

66 1x 1x 1x 1x

67 1x 1x 1x 1x

68 4 62 57 67

69 1x 1x 1x

70 1x 1x

71 2x

72 2x 2x

73 1x 1x 1x

74 1x 1x 1x

75 1x 1x 2x 2x 1x

76 75 68

77 1x

78 2x 2x 2x

79 2x 4x

80 2x 2x 2x

81 80 77

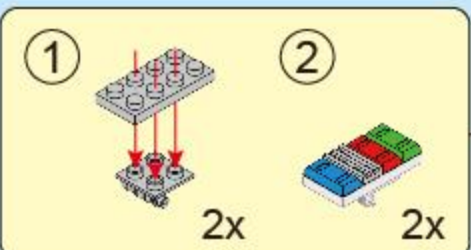
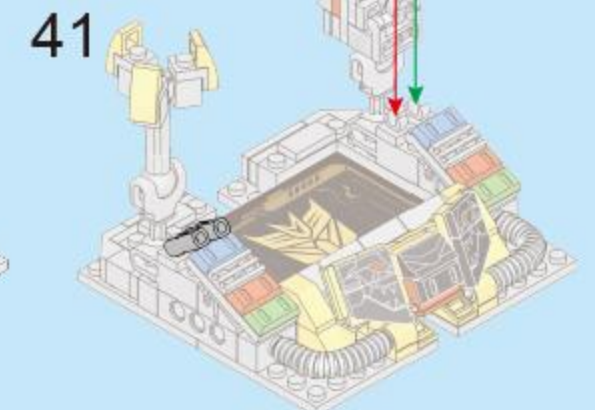
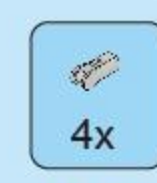
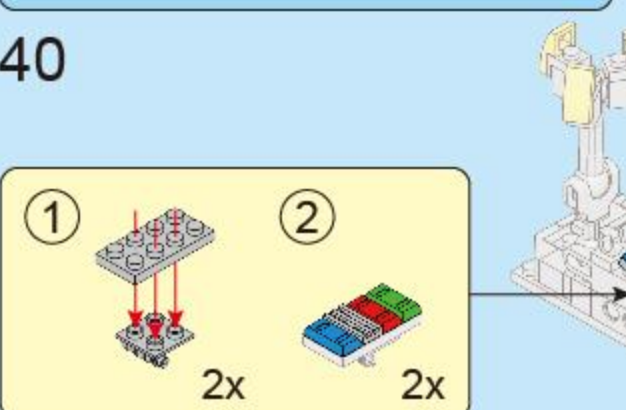
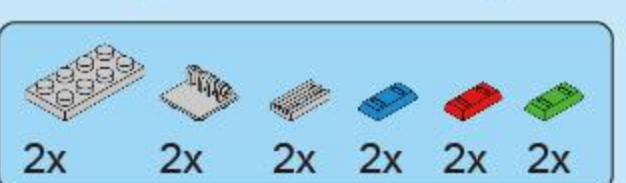
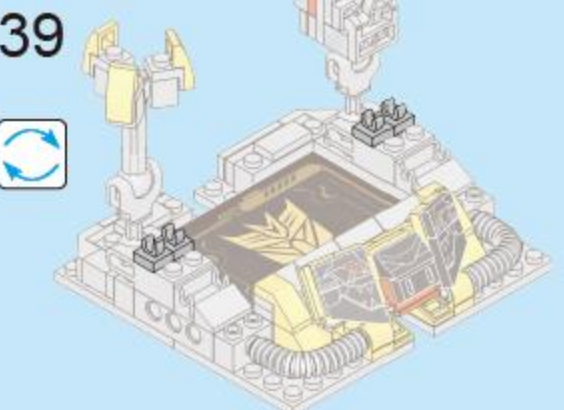
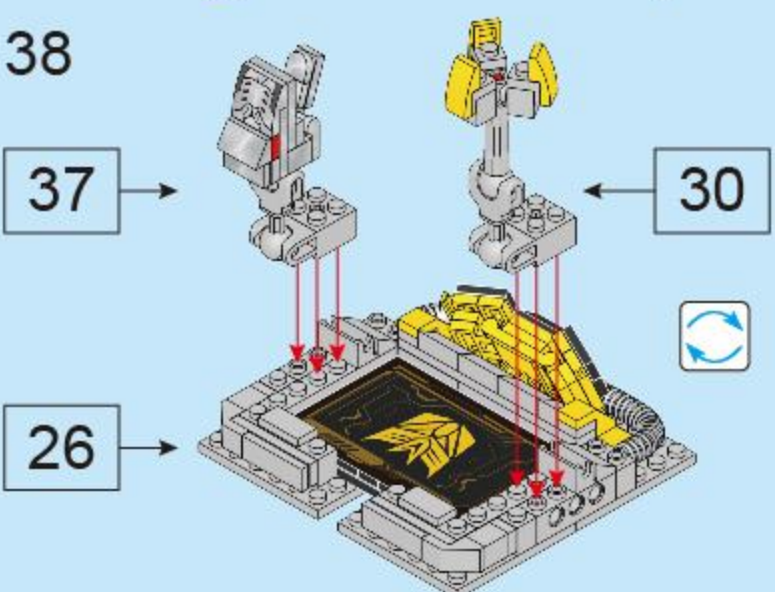
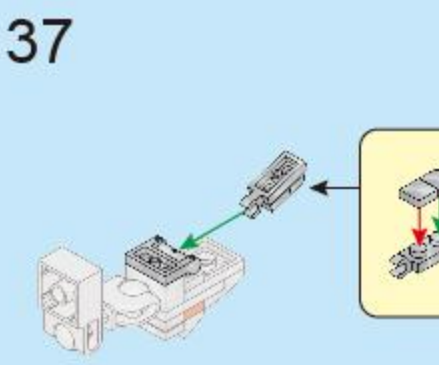
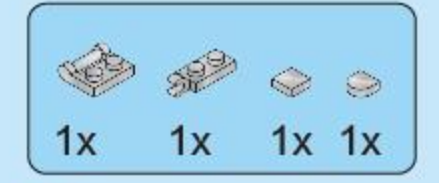
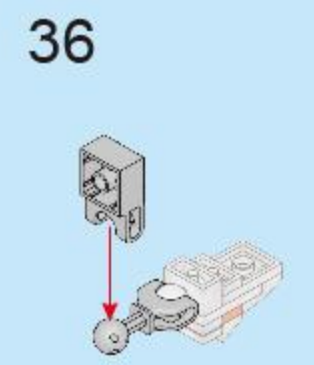
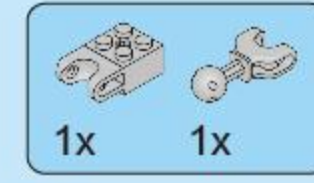
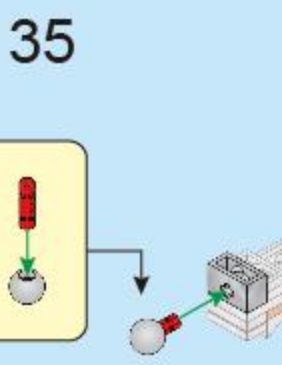
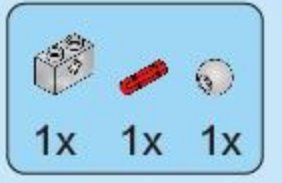
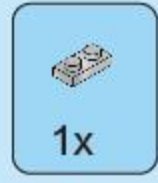
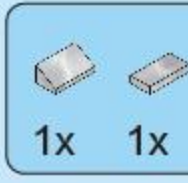
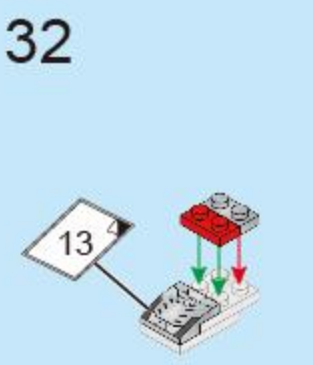
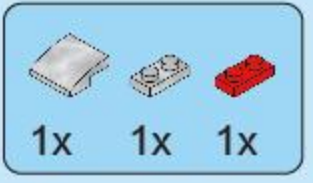
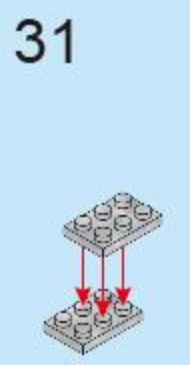
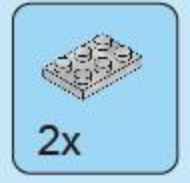
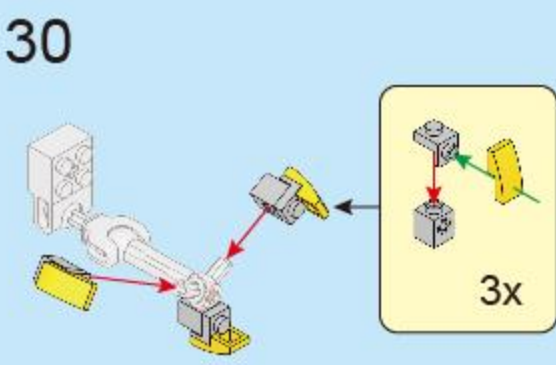
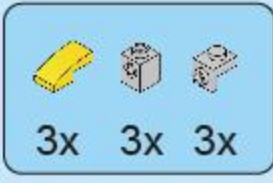
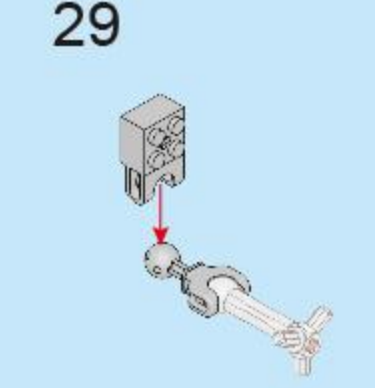
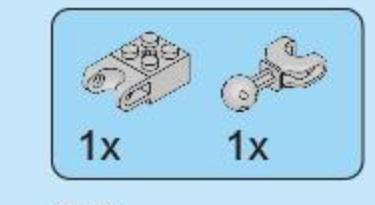
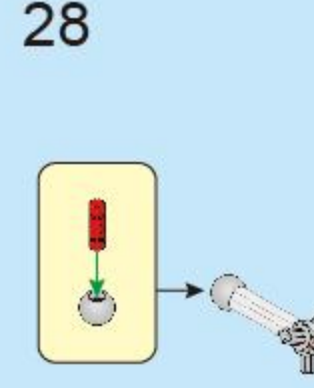
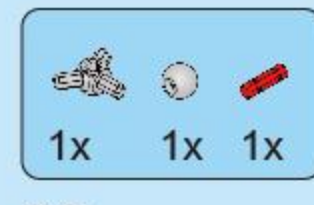
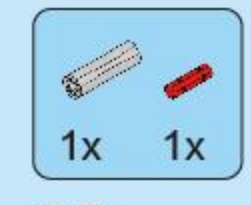
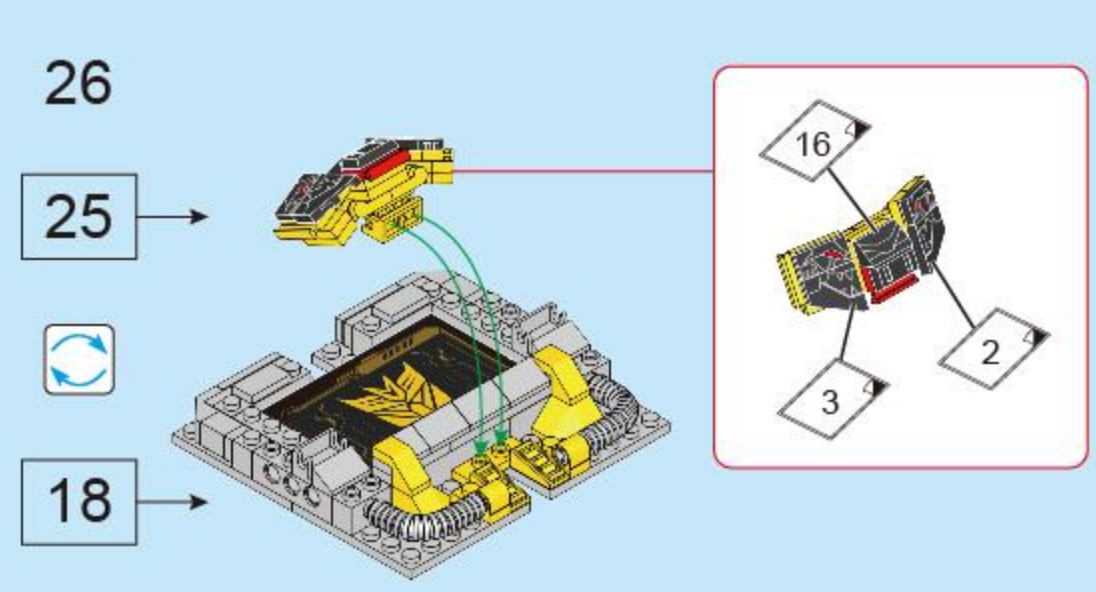
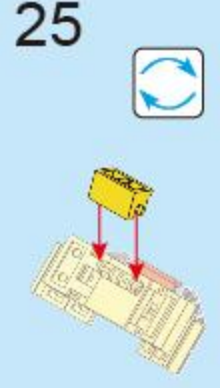
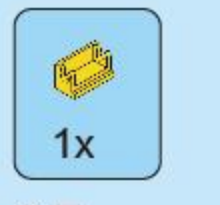
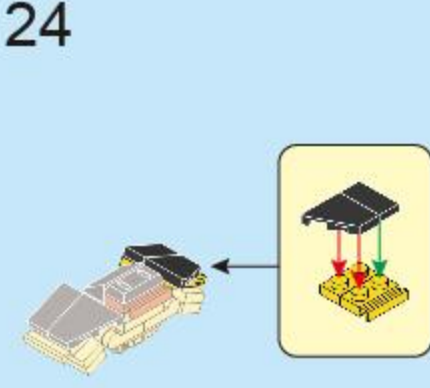
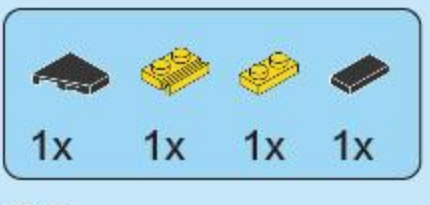
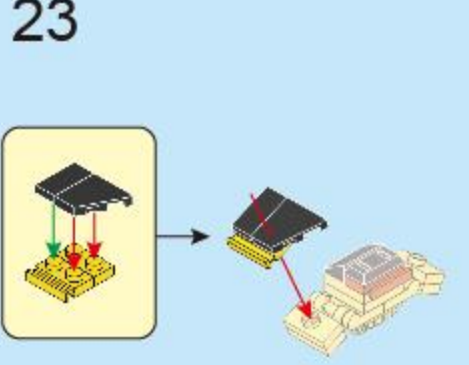
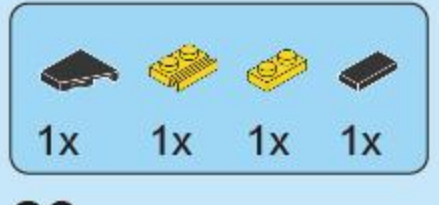
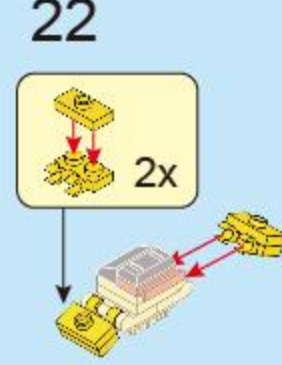
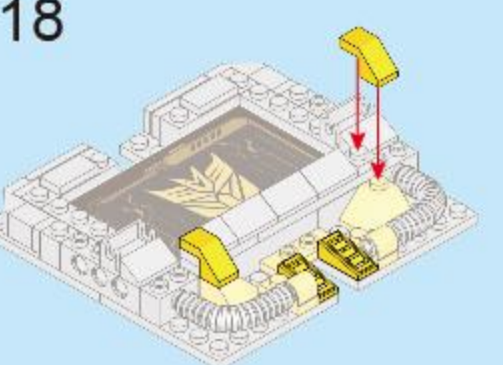
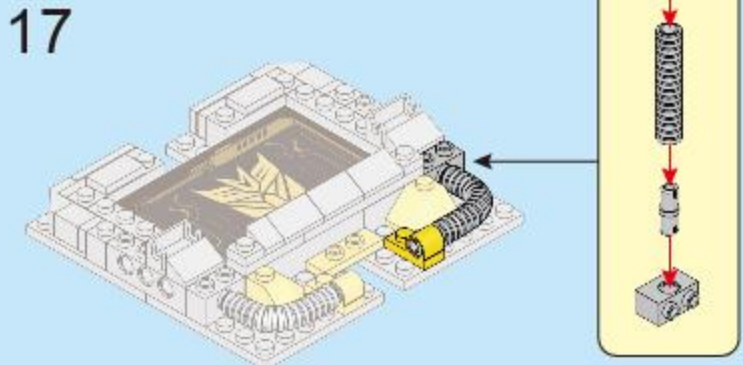
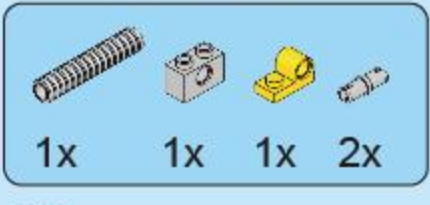
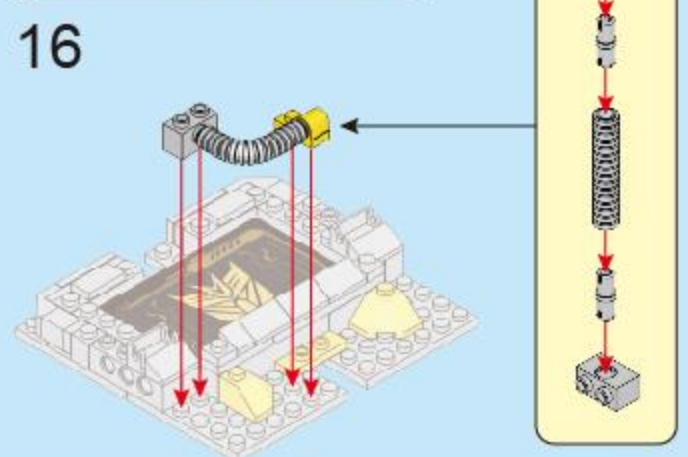
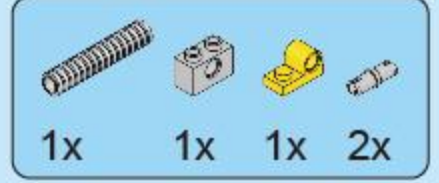
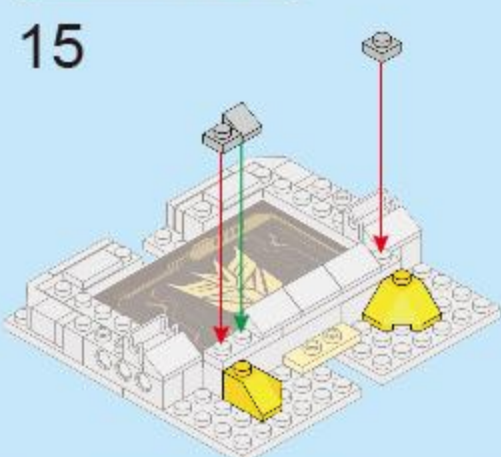
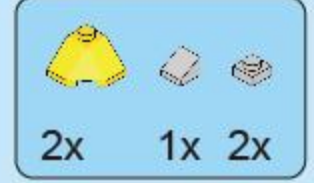
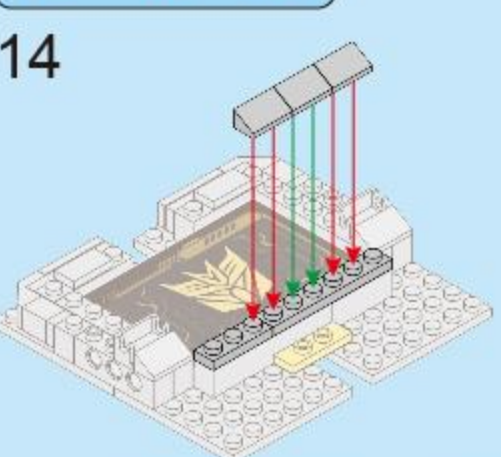
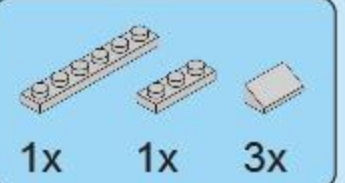
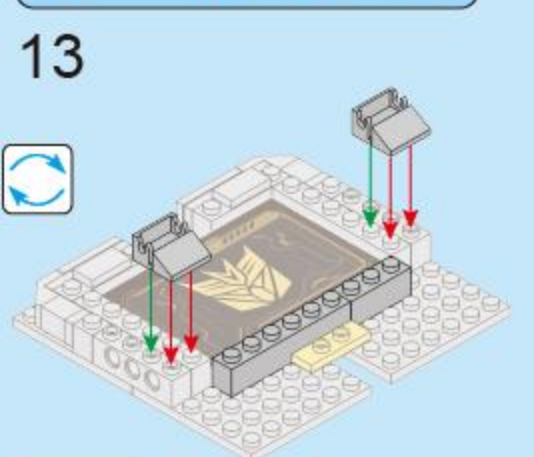
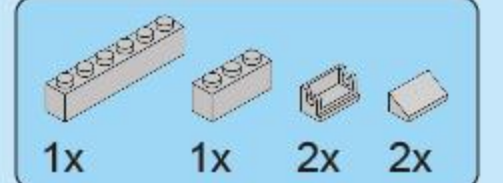
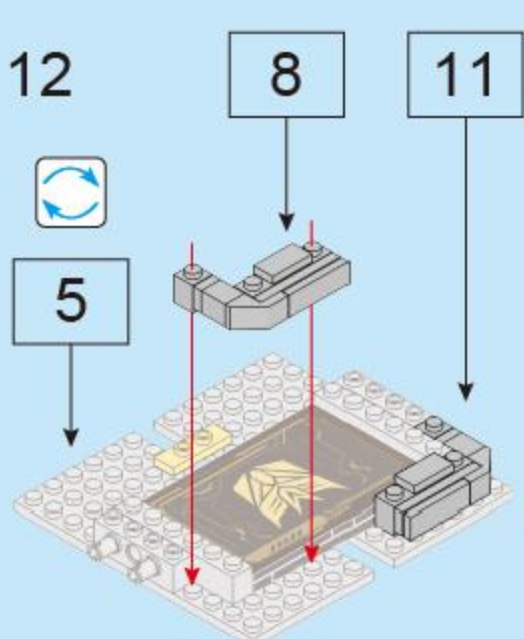
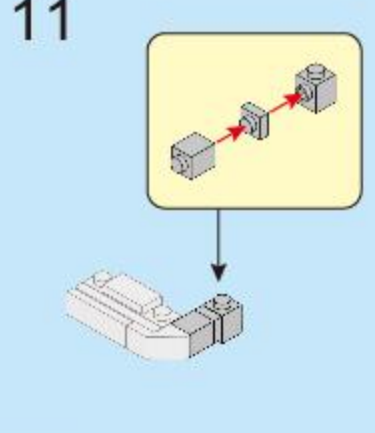
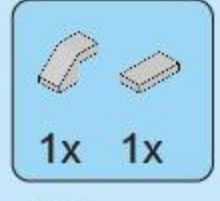
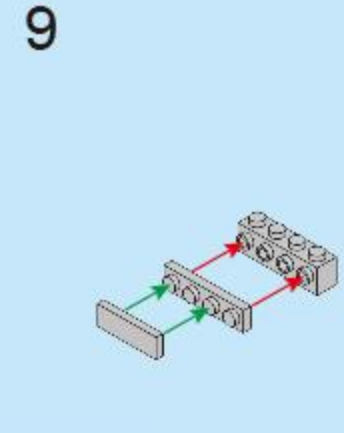
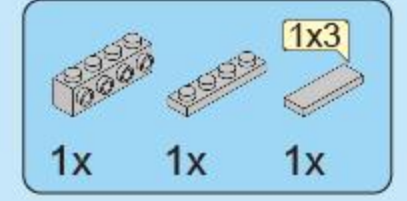
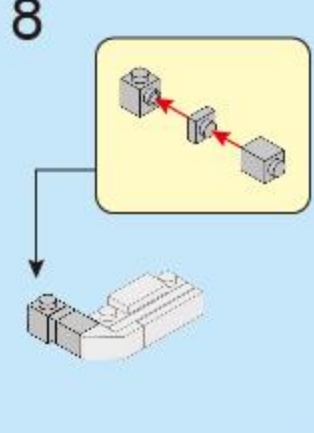
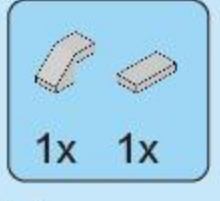
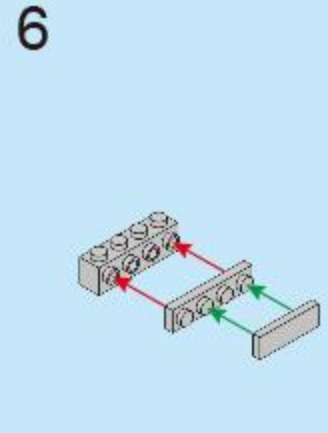
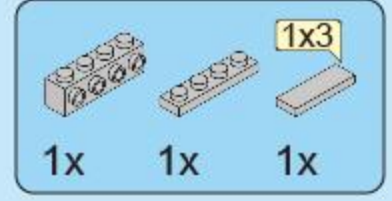
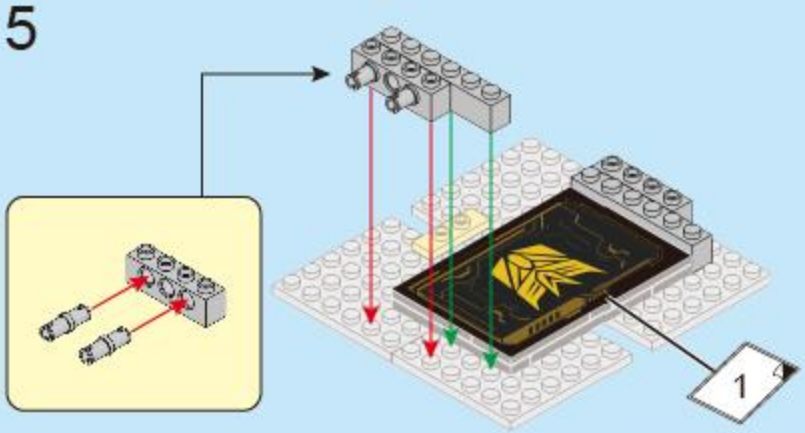
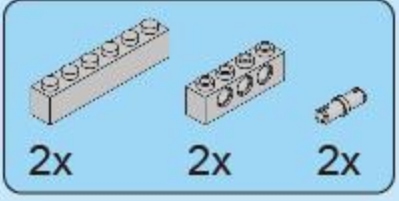
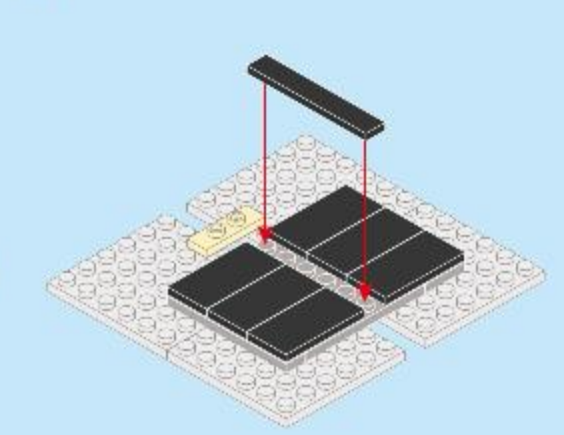
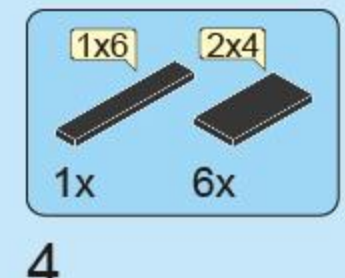
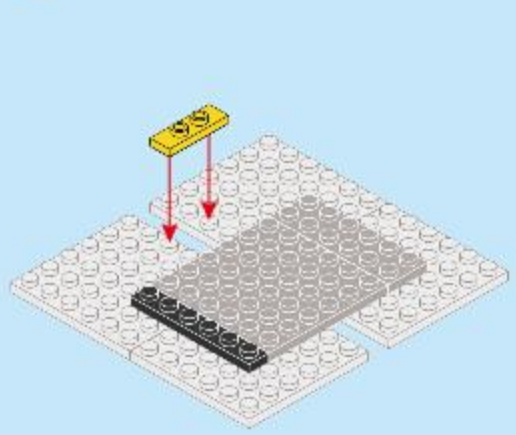
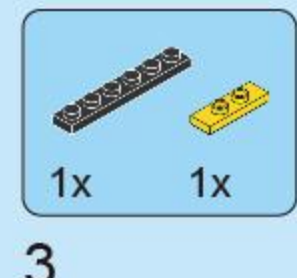
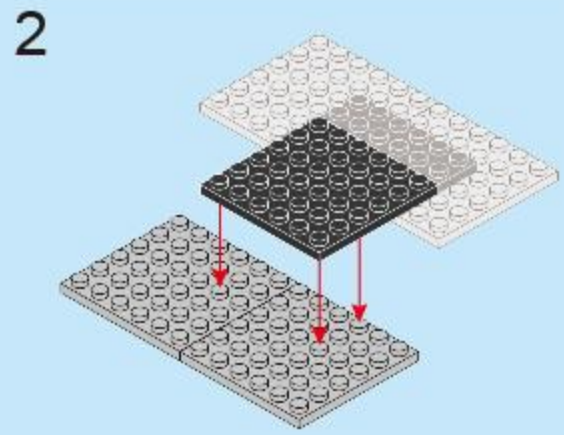
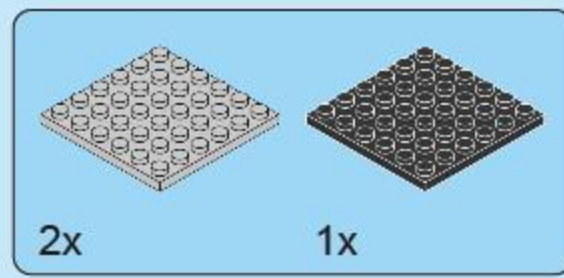
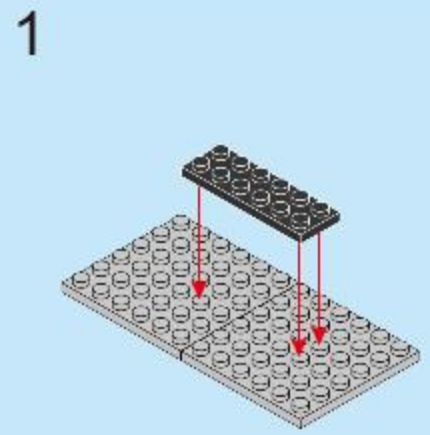
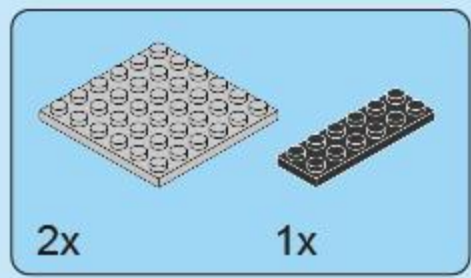

1x 2x 42
 1x 1x 43
 1x 1x 1x 44
 2x3 1x 2x 45
 2x 2x 46
 2x 47
 2x3 1x 3x 48
 49
 2x 2x 2x 50
 2x 51
 1x3 1x 1x 1x 52
 1x 3x 53
 1x3 1x 1x 1x 54
 1x 1x 1x 1x
 55
 1x 1x 1x 56
 1x 1x 1x 57
 2x 2x 58
 1x 1x 59
 2x 2x 60
 1x 2x 61
 1x 1x 2x 62
 1x 1x 1x 63
 1x 1x 1x 1x 64
 1x 1x 1x 1x 65
 1x 2x 66
 1x 1x 2x 67
 1x 1x 1x 68
 1x 1x 1x 1x 69
 70
 1x 1x 1x 1x 71
 1x 1x 72
 2x 2x 73
 2x 2x 2x 74
 1x 1x 1x 75
 1x 1x 1x 76
 1x 1x 1x 77
 78
 2x 2x 79
 2x 2x 80
 81
 1x 1x 1x 82
 1x 2x 83
 1x 1x 84
 2x 1x 1x 85
 86
 1x 1x 1x 87
 1x 2x 88
 1x 1x 89
 1x 90
 85 81 89

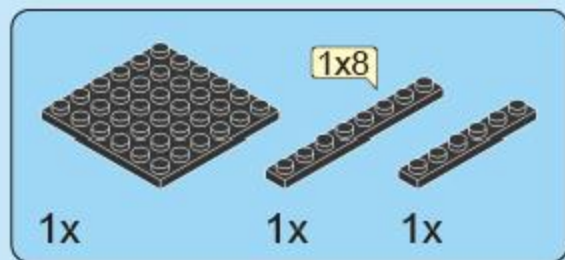

1

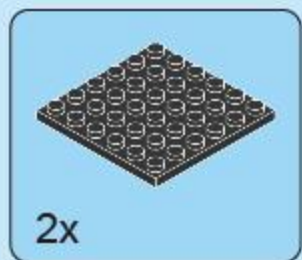

2

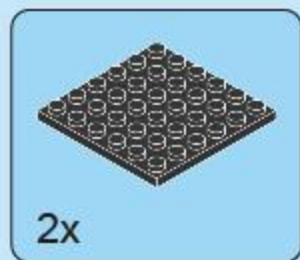

3

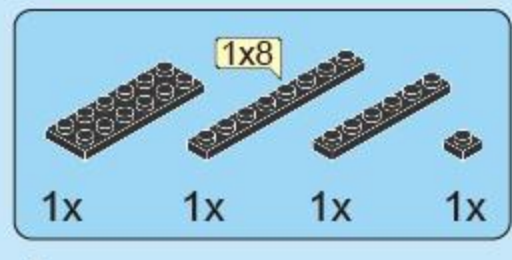

4

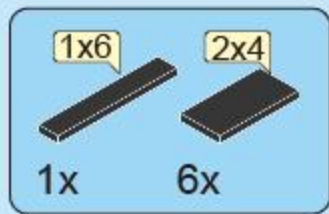
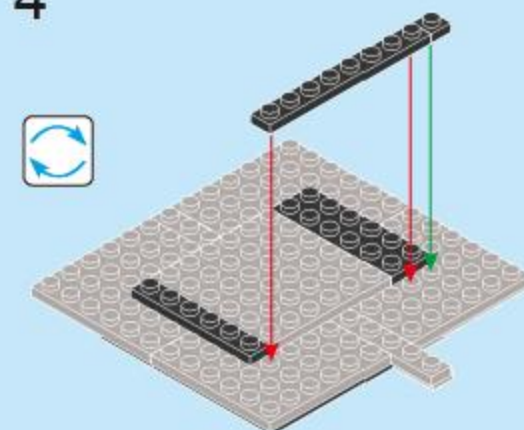
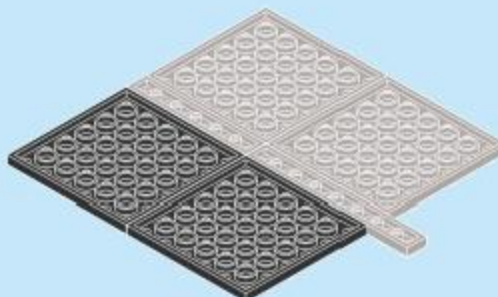
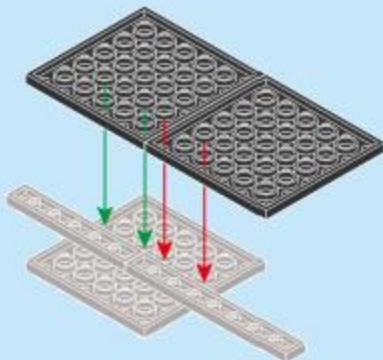
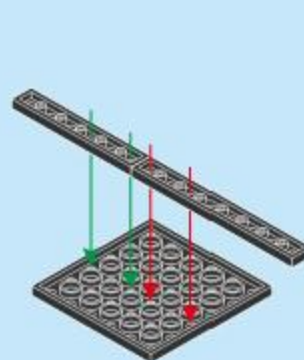

5

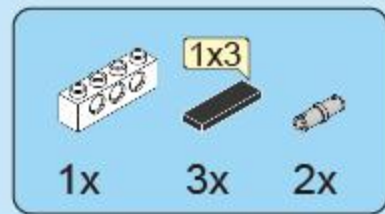

6

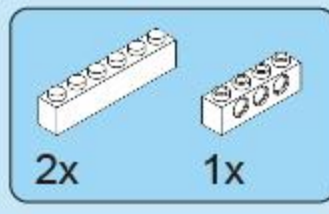

7

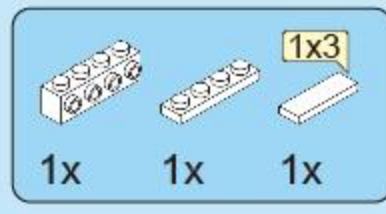

8

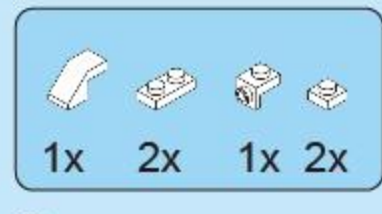

9

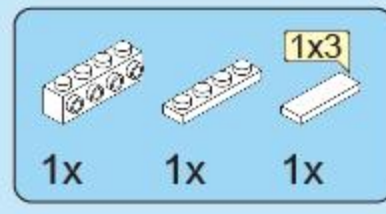

10

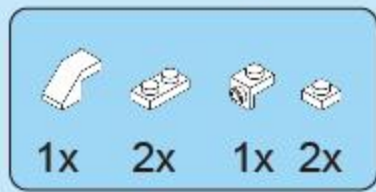
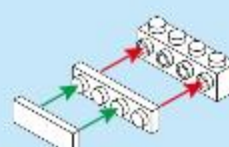
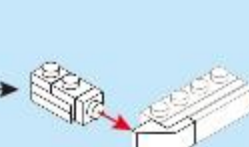
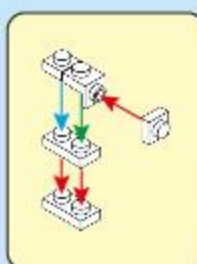
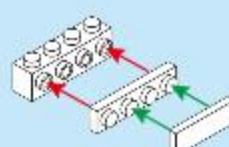
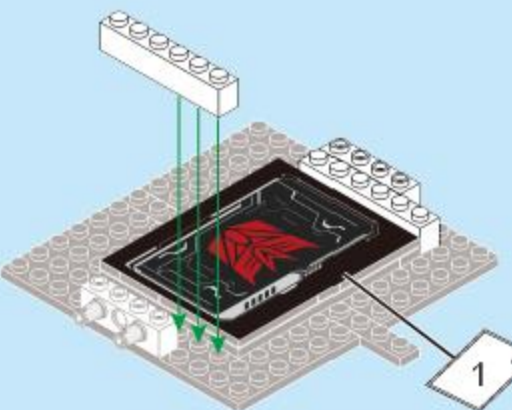
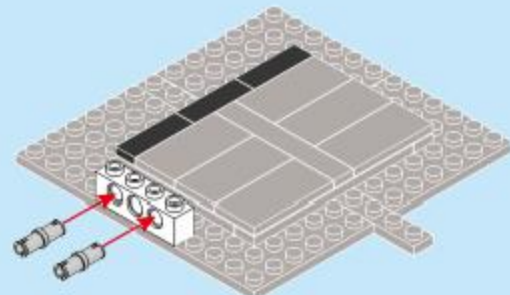
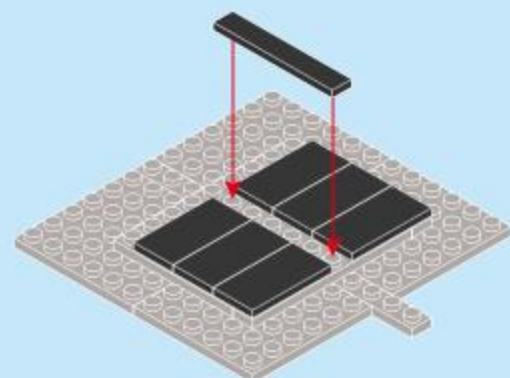

11

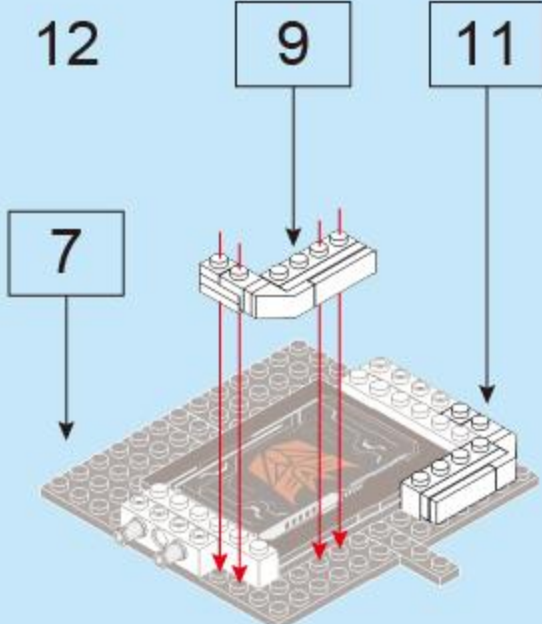

12

9

11

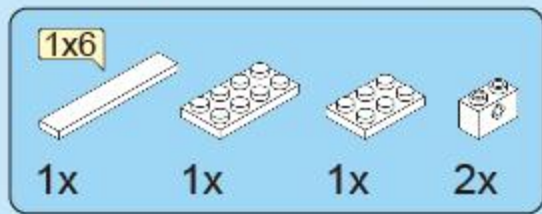

13

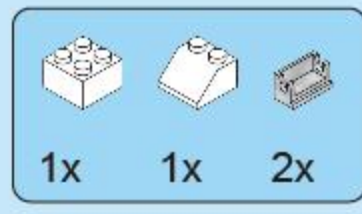

14

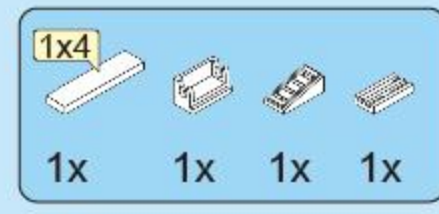

15

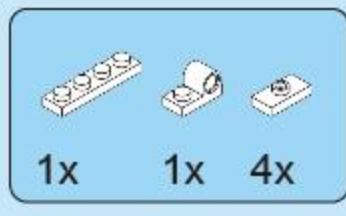
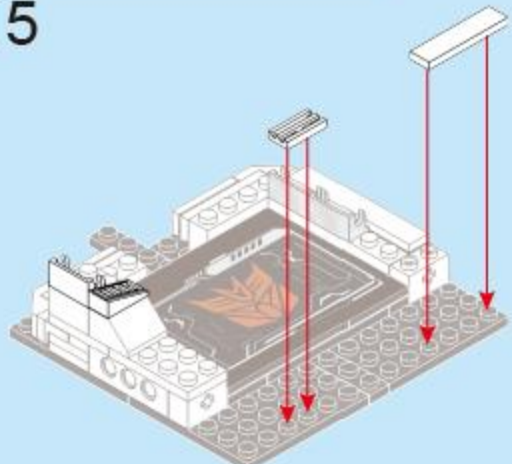
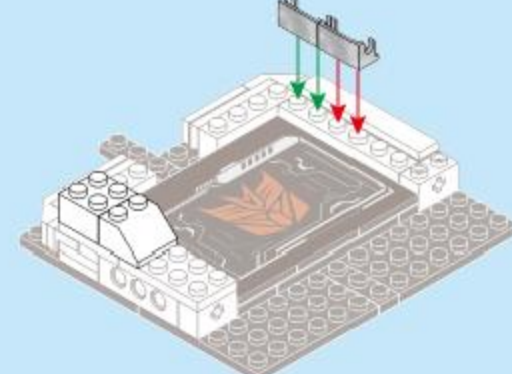
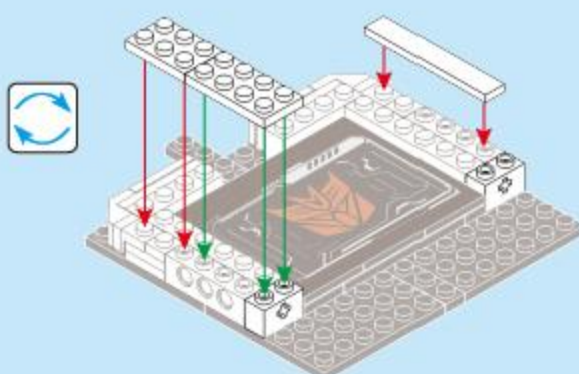
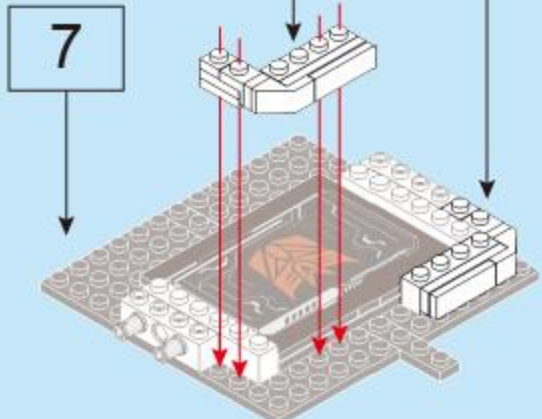
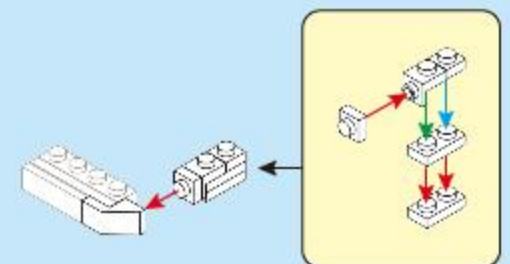

16

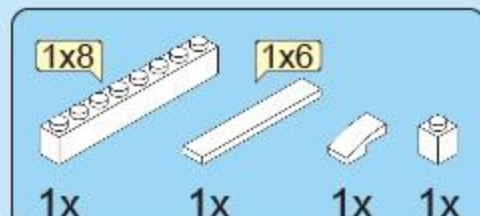

17

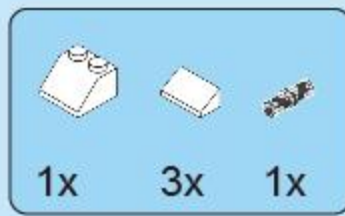

18



19

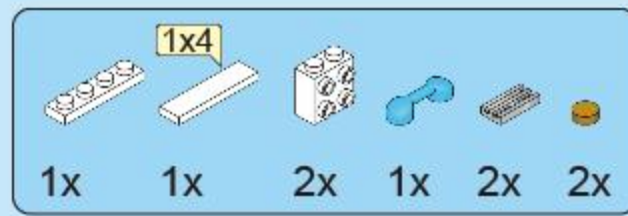

20

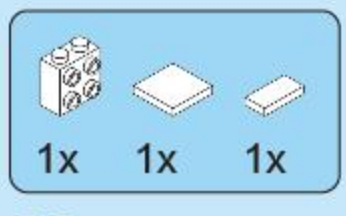
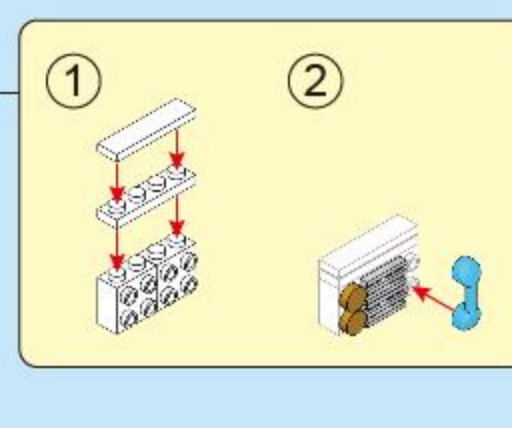
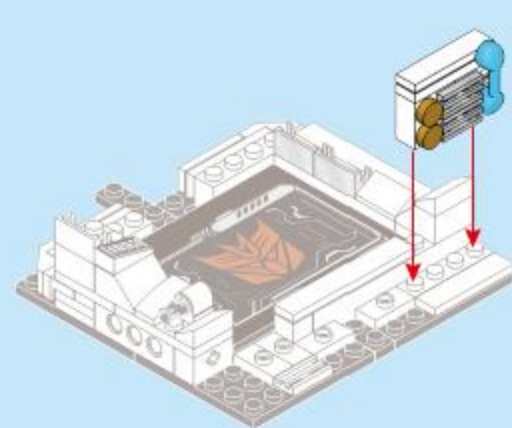
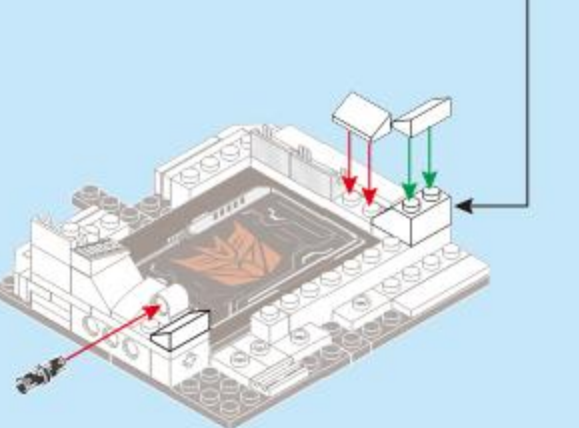
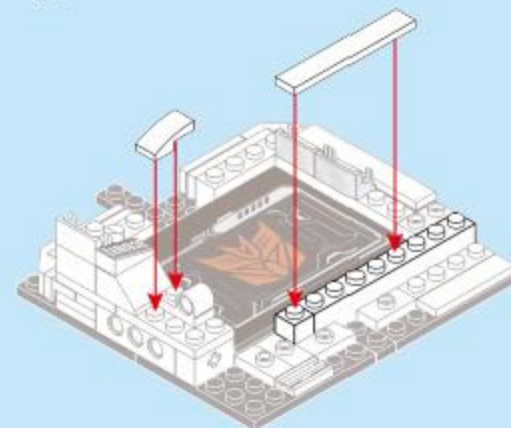
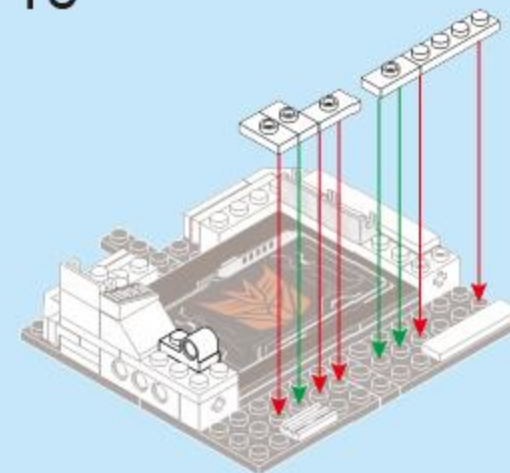

21

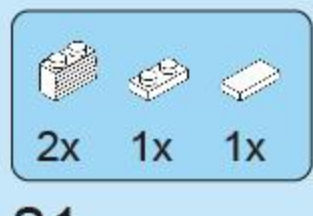

22



23



24

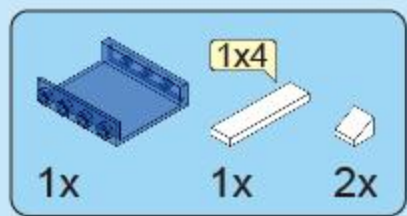

25

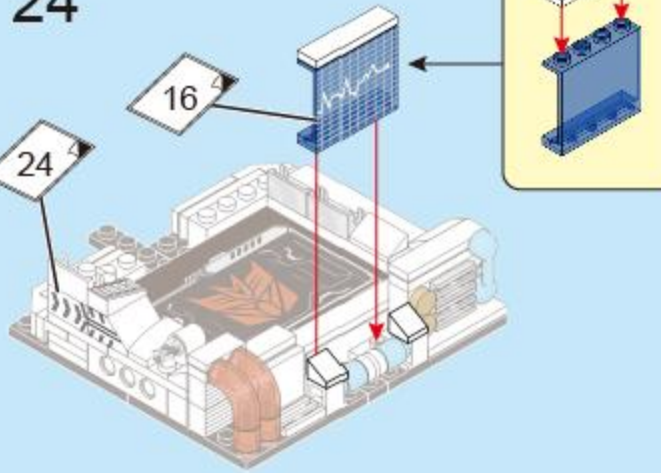
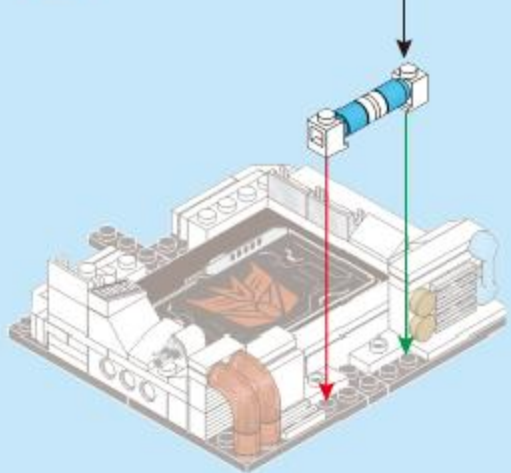
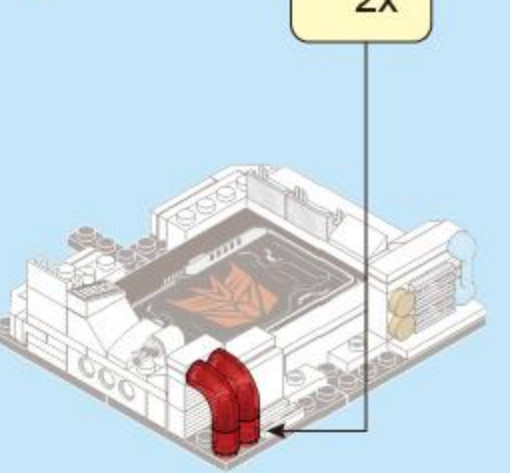
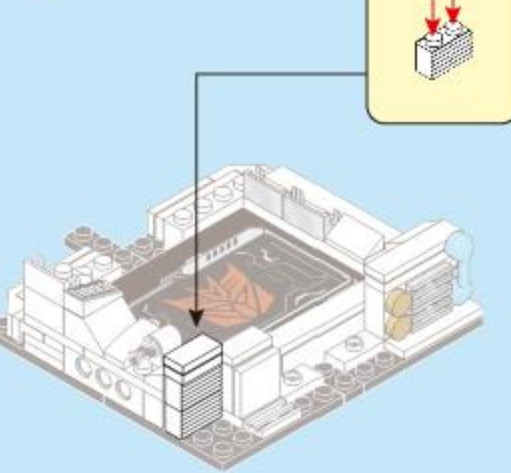
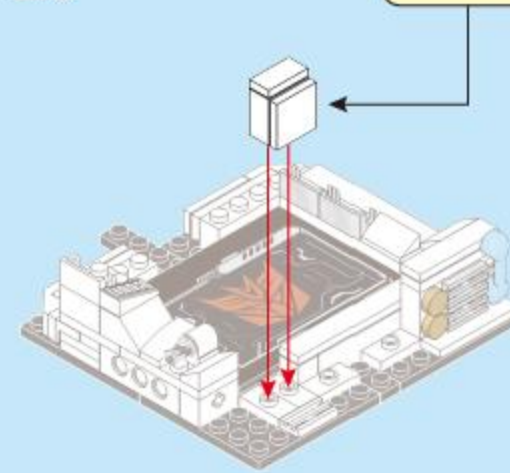

26



27



28

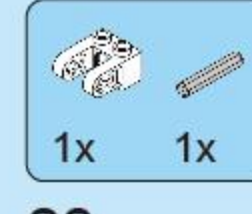

29

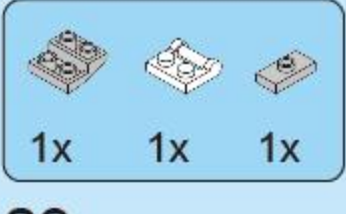

30

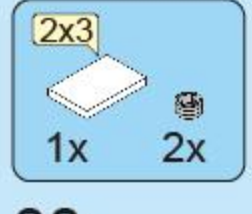

31

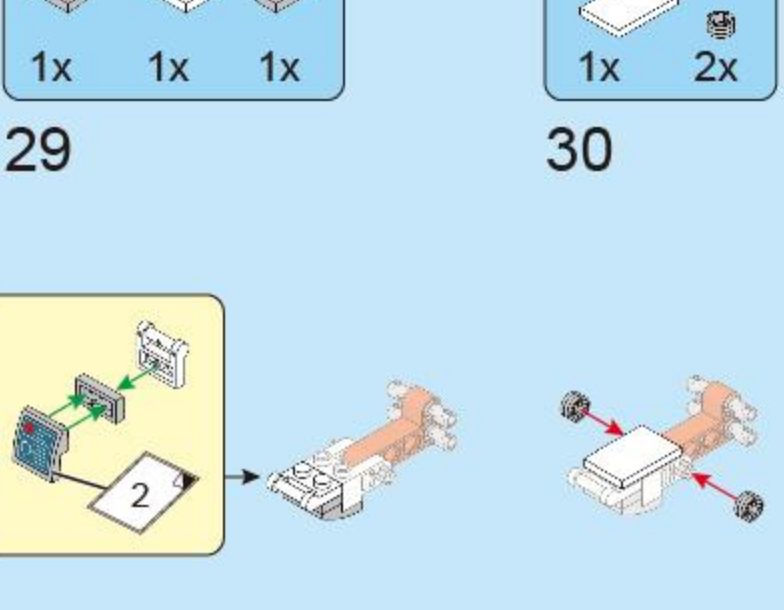
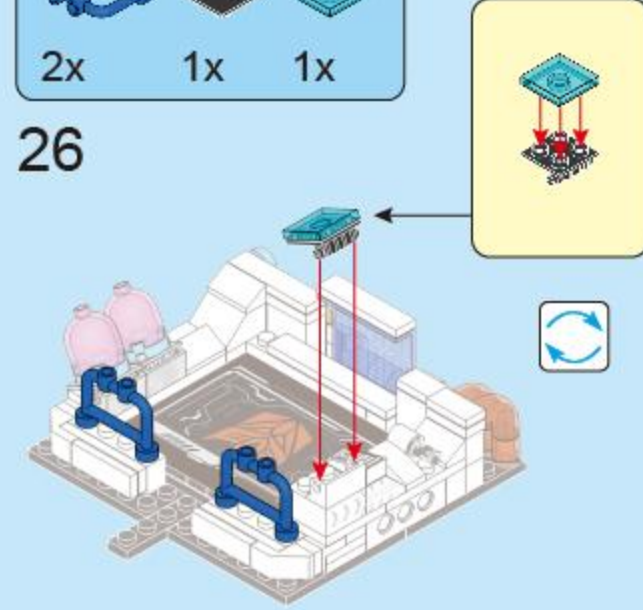
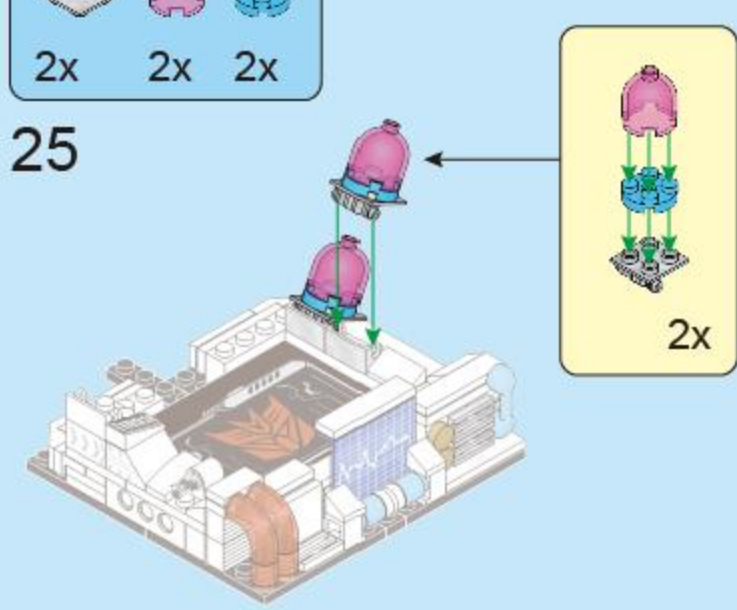

31
1x 1x 1x

32
1x 1x 1x

33
1x 1x 1x 2x

34
2x3
1x 3x

35
34
26
3

1 2

36
1x 1x 1x

37
1x 1x 1x

38
1x 1x

39
2x 2x

40
1x 1x 1x

41
1x 2x 1x 1x

42
1x 1x 2x 1x 2x

43
35
42
40
44
45
46
47
48
49

43
35
42
40
44

45
46
47
48
49

50
1x 2x

51
1x 1x 2x

52
1x 1x 1x

53
1x 1x 1x 1x

54
1x 1x 1x 1x

55
1x 2x

56
1x 1x 2x

57
1x 1x 1x

58
1x 1x 1x 1x

59
1x 1x 1x 1x

60
17
17
54
49
59

61
1x 1x

62
2x 2x

63
2x 2x

64
2x 2x

65
1x3
1x 1x 2x

66
1x 1x 2x 1x

67
1x 1x

68
1x 1x 1x

69
7
9
10
68
65
60

70
69
60

71
1x

72
1x 1x 1x

73
1x 1x 2x

74
1x 1x 1x

75
2x

76
1x 1x 1x

77
1x 1x 2x

78
1x 1x 1x

79
2x

80
75
71
79