

FC3327-1



4 IN 1
ENGINEERING
CONSTRUCTION TEAM



CITY
CITY

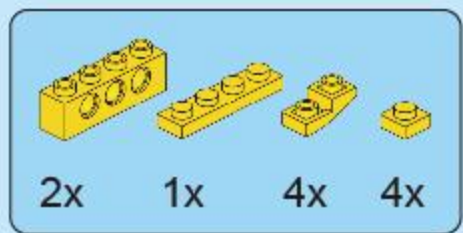

A1

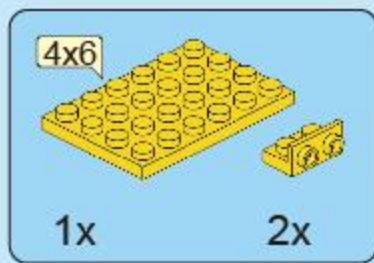
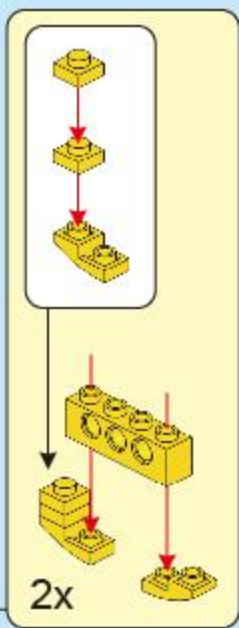
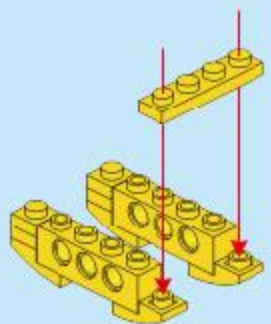

A2

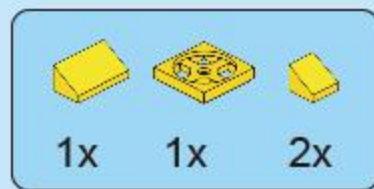
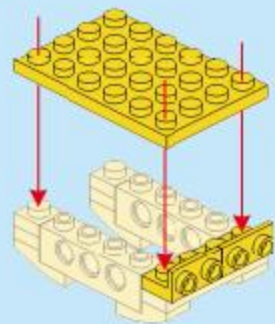

A3

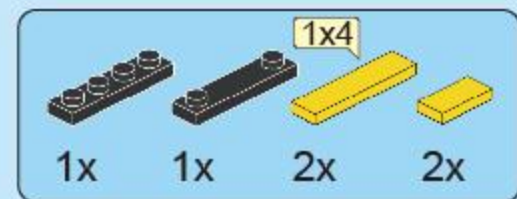
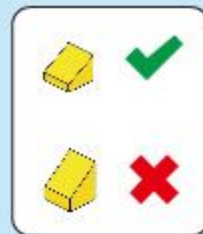

A4

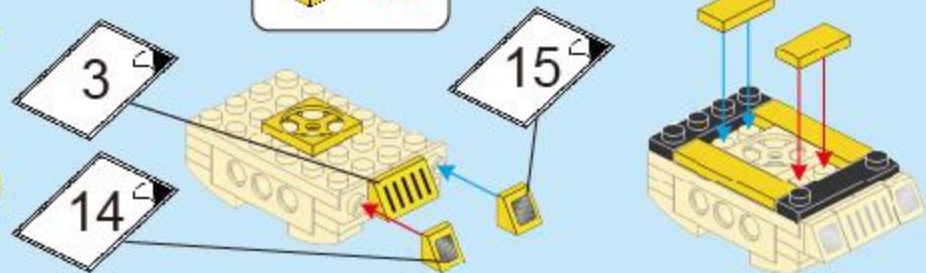

A5

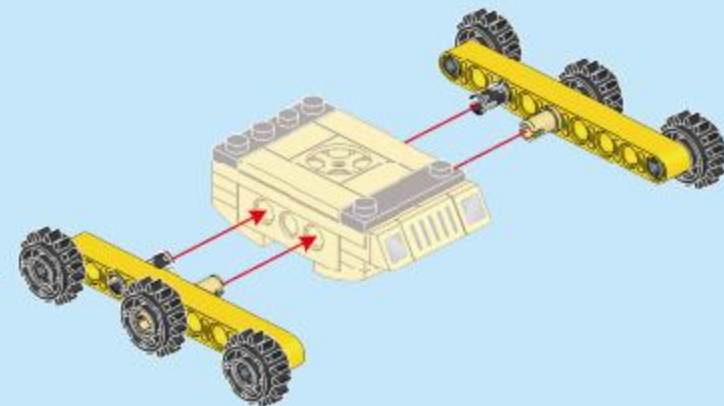
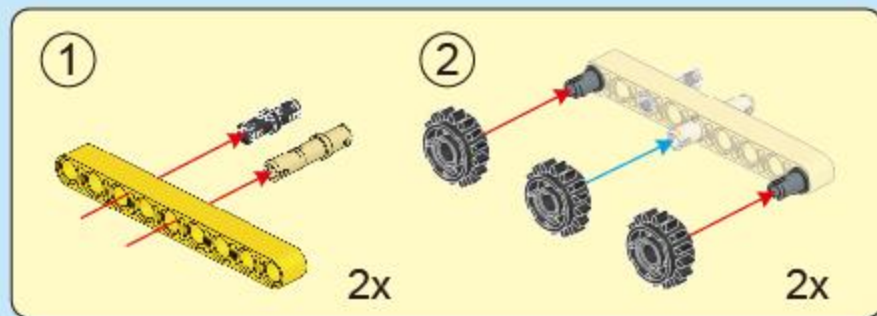



A6

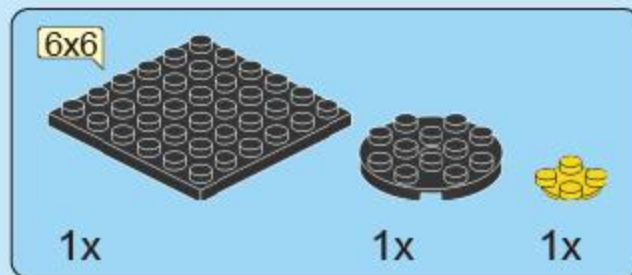
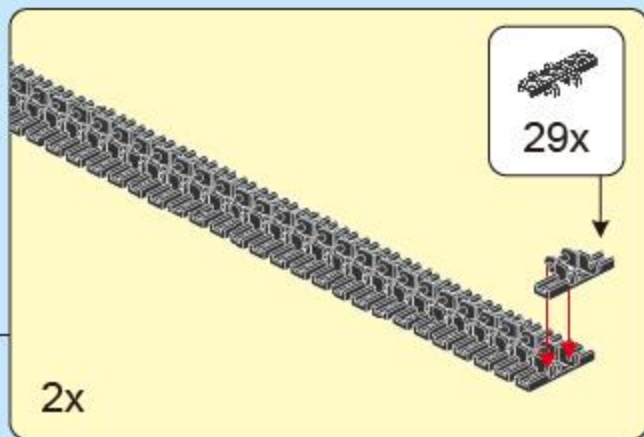
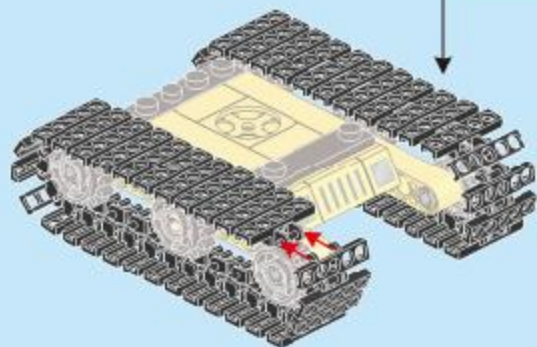

A7

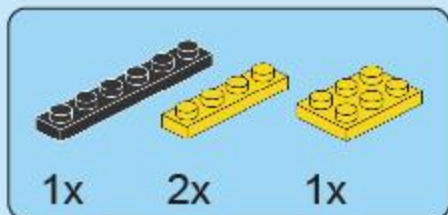
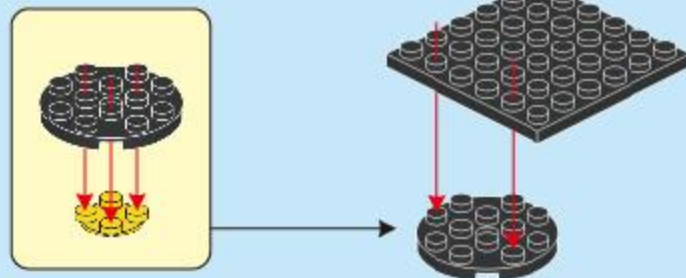

A8

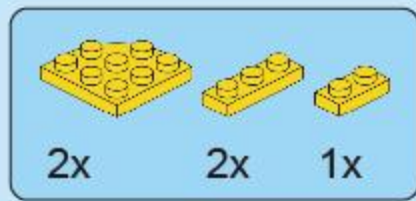

A9

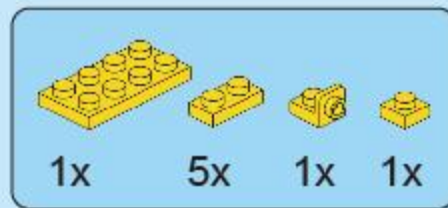
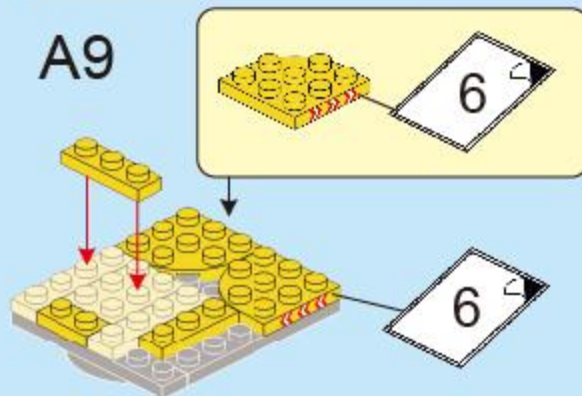

A10

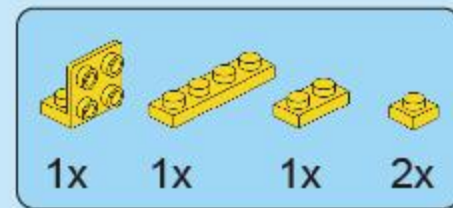
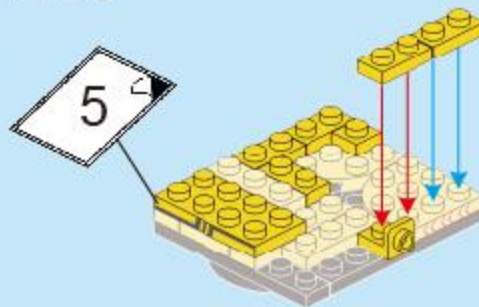

A11



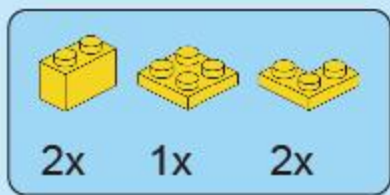

A12

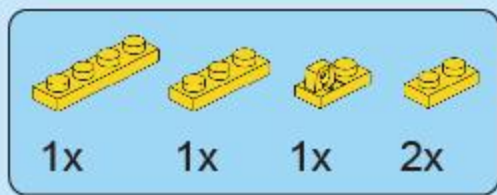
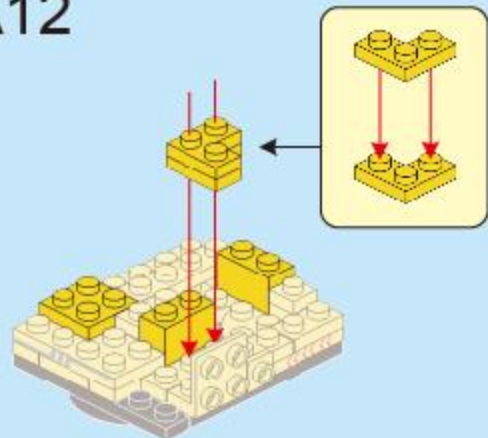

A13

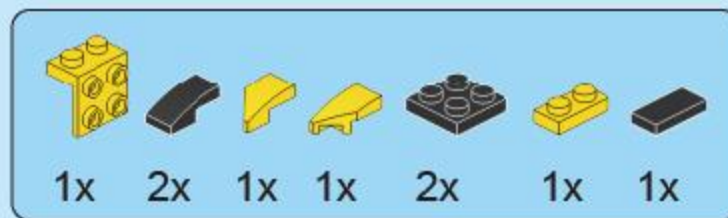

A14

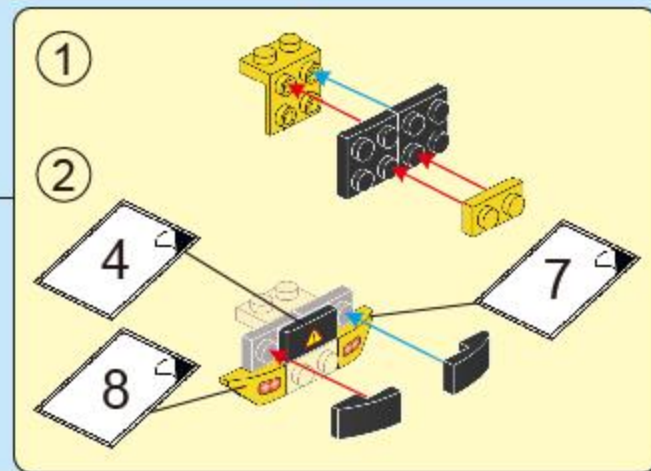
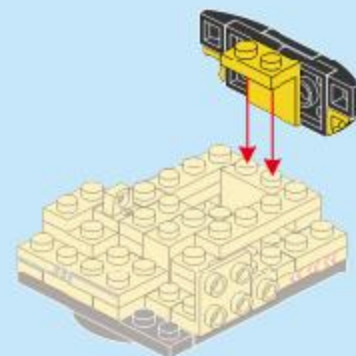

A15

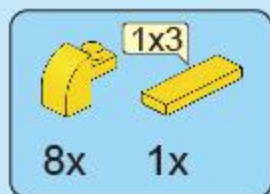
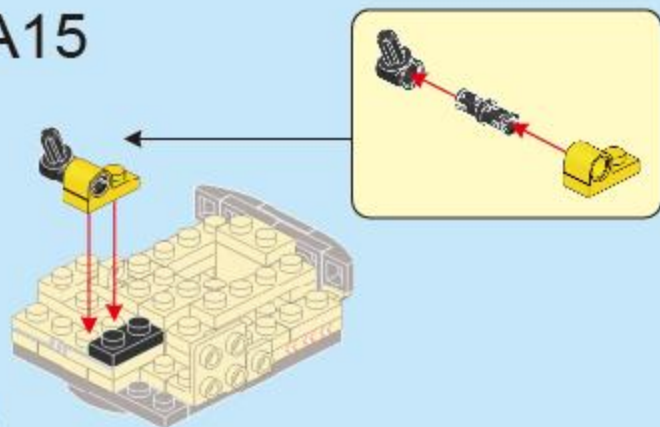

A16

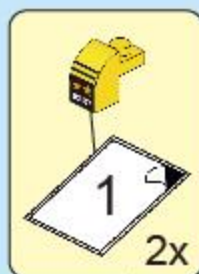
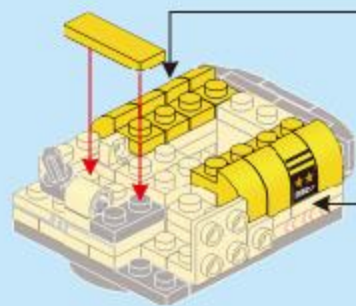

A17

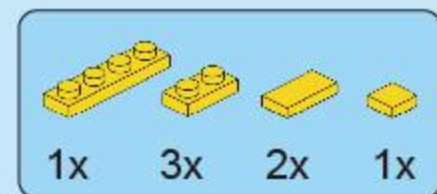
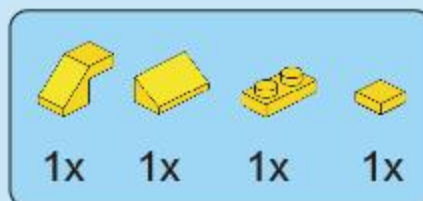
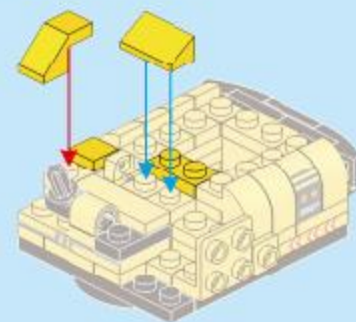

A18



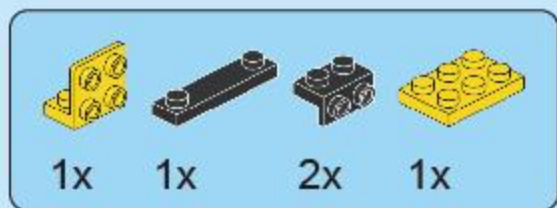

A19

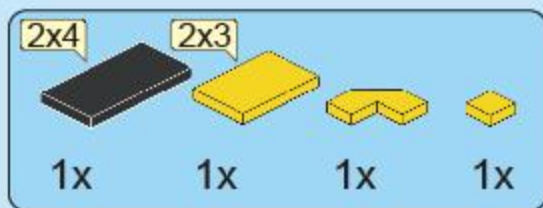
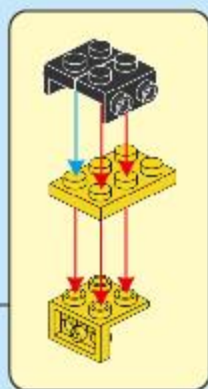
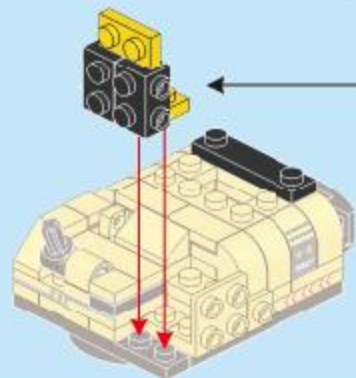

A20

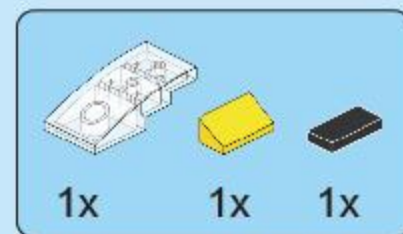
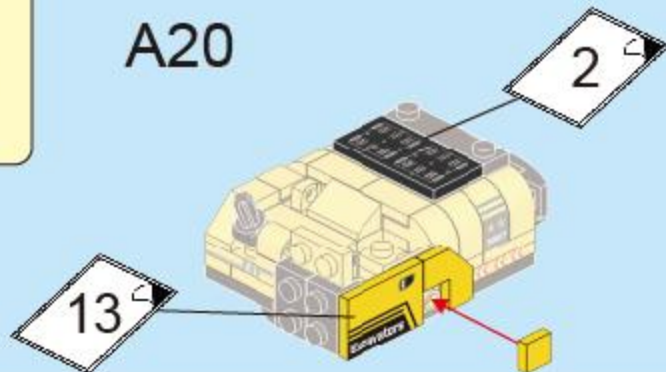

A21

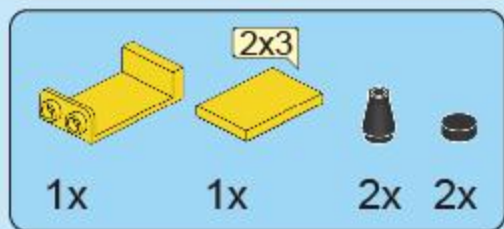

A22

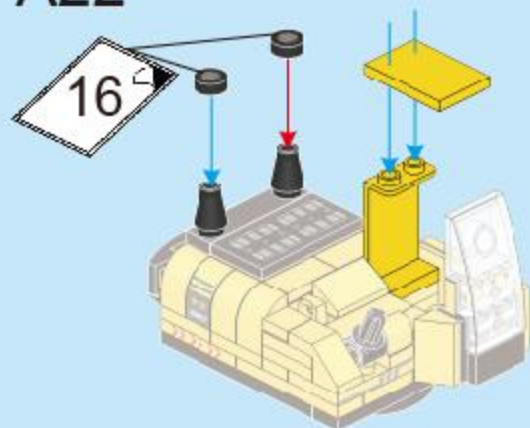

A23

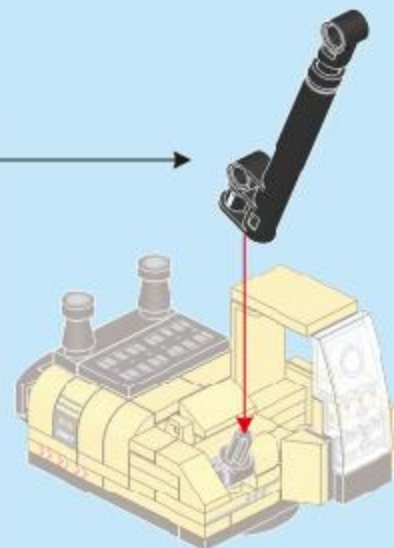
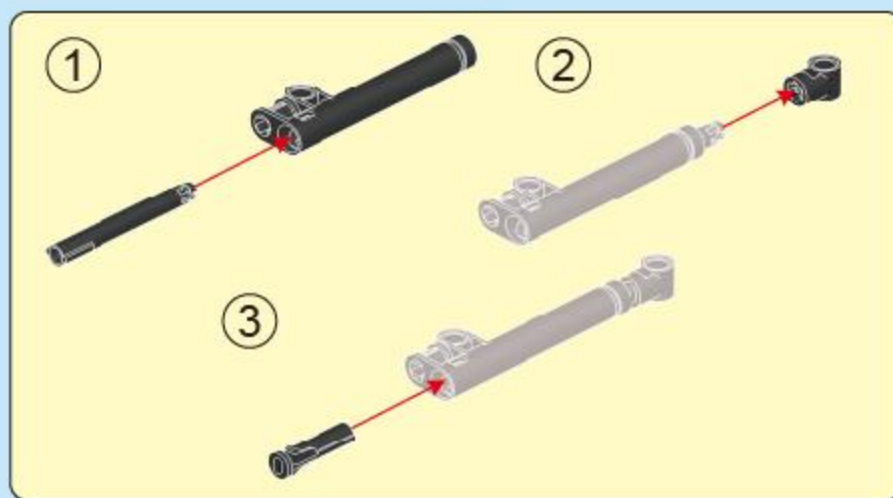

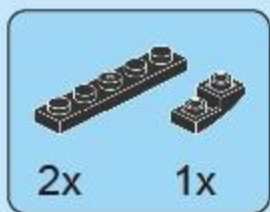

A24

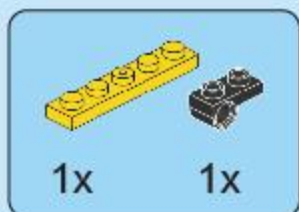
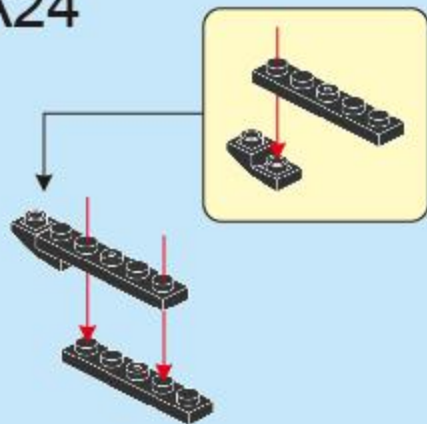

A25

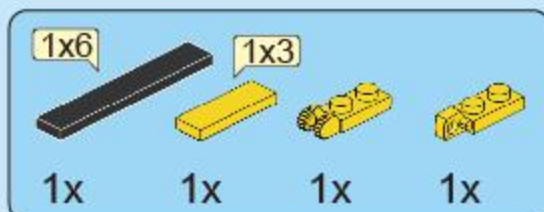
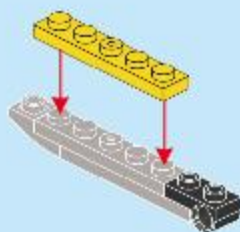

A26

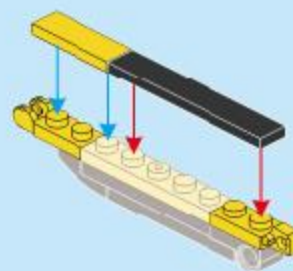

A27

A26



A23

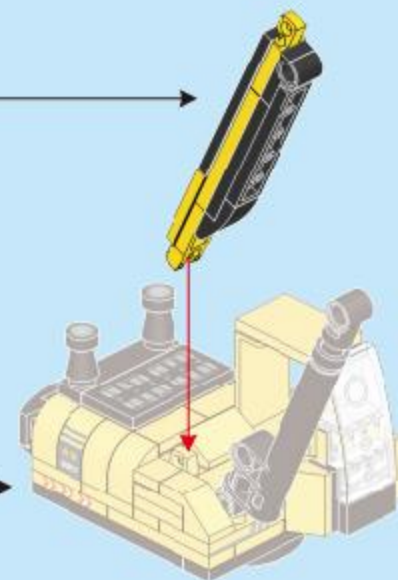

A28

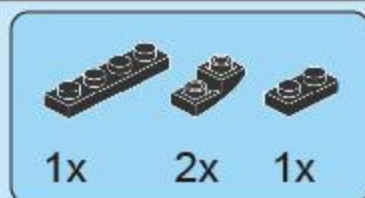
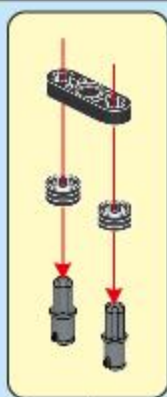
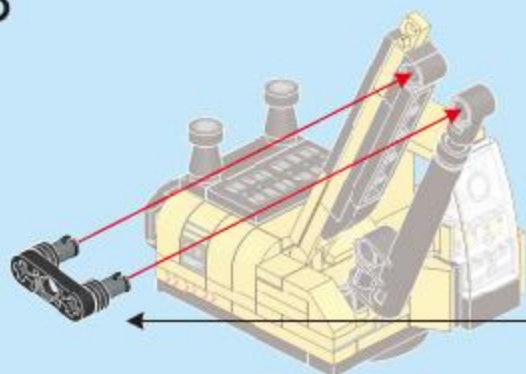

A29

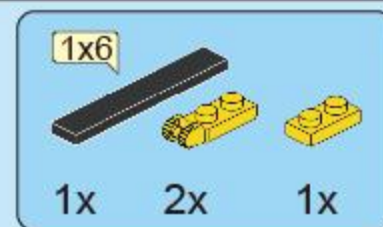
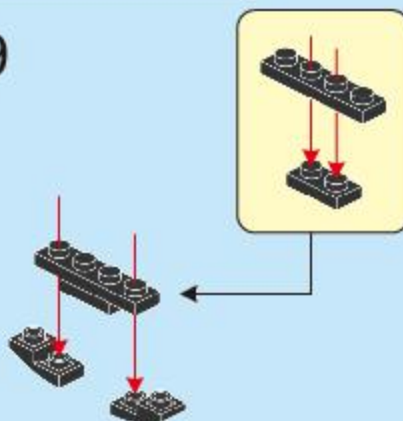

A30

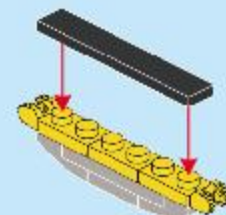

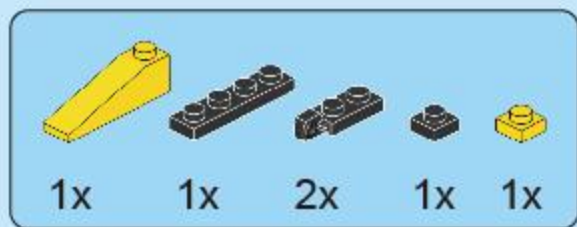

A31

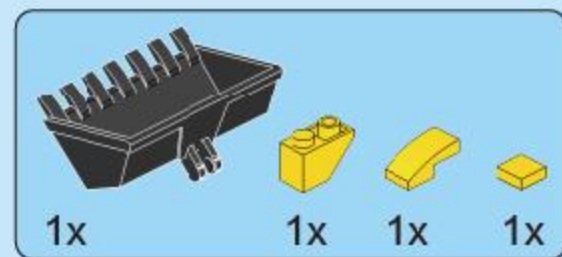
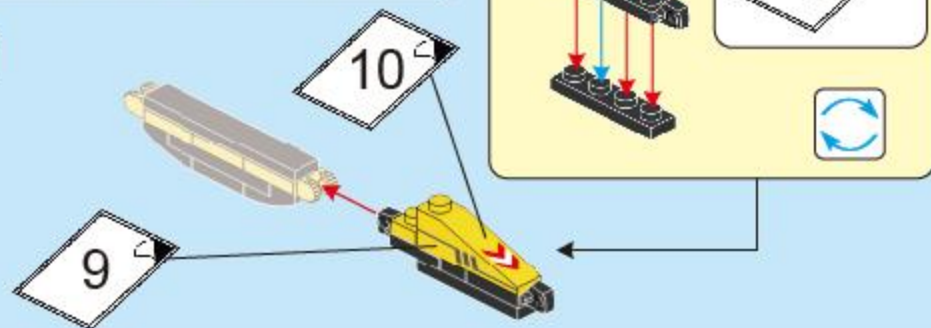

A32

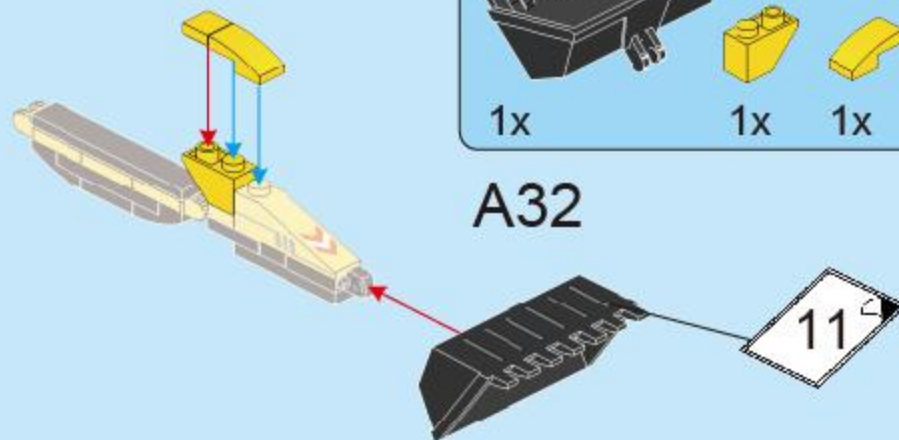

A33

A28



A32

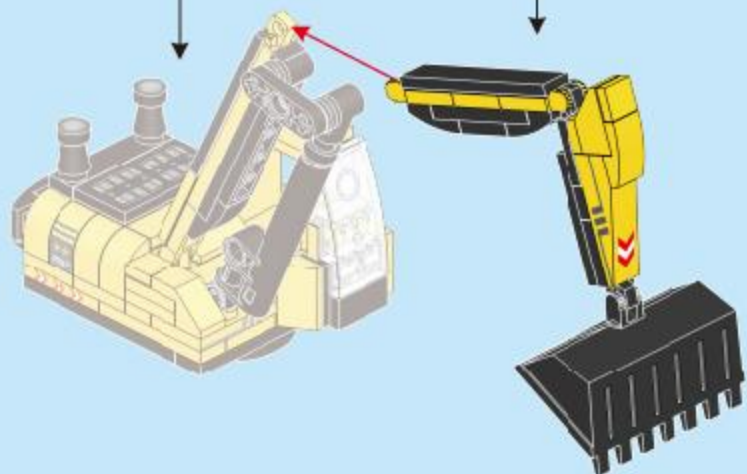

A34

A33

A6

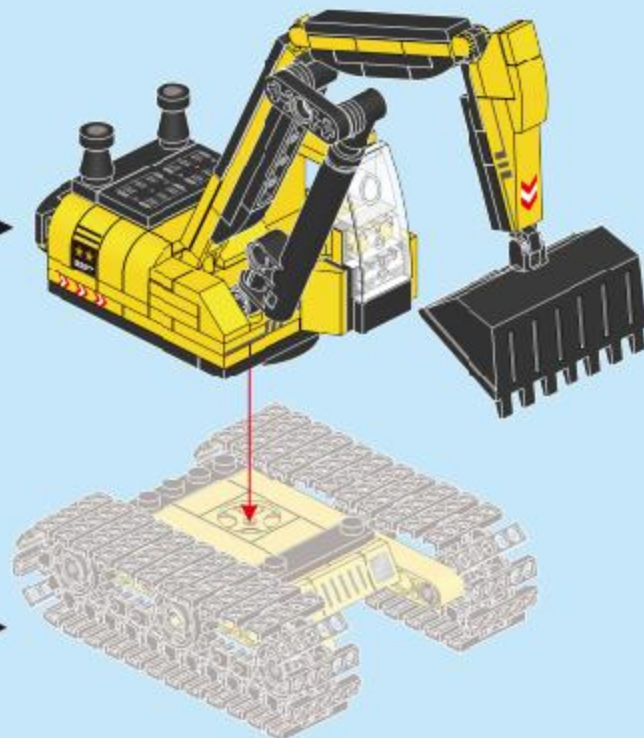

A

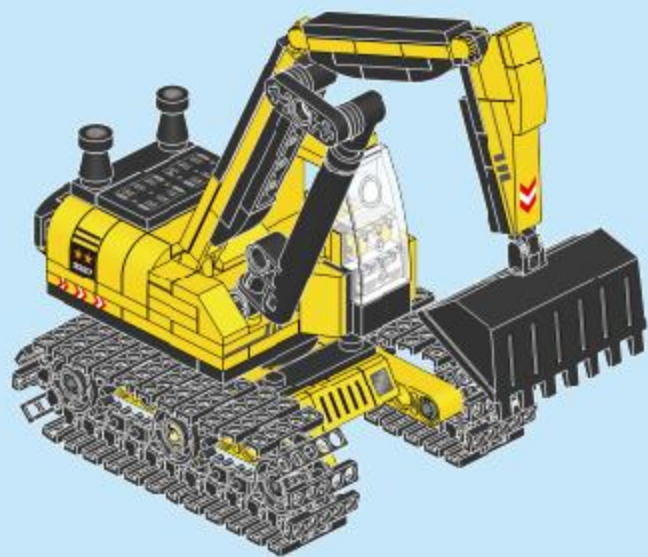

4IN1



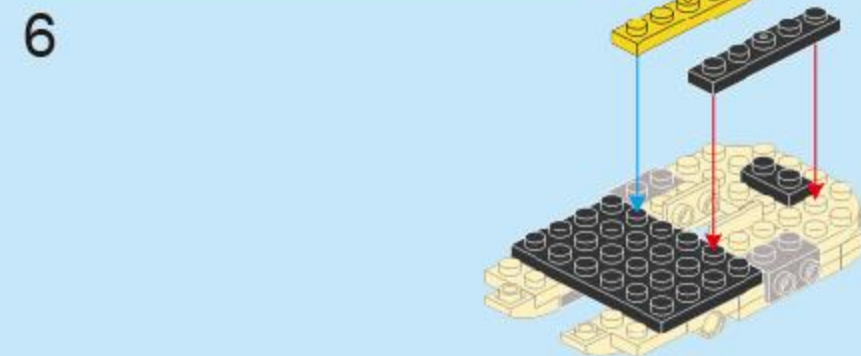
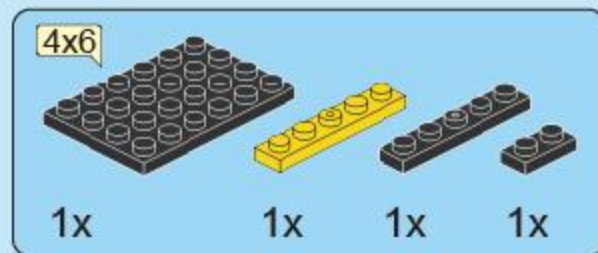
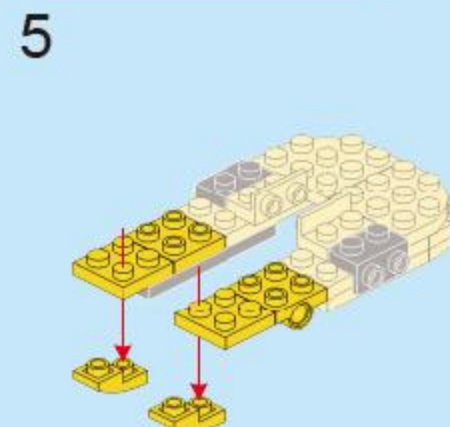
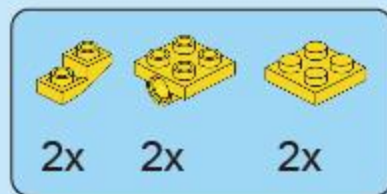
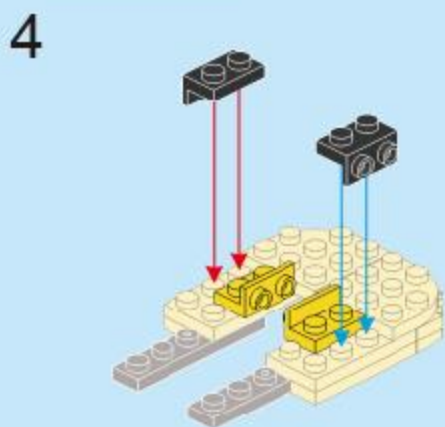
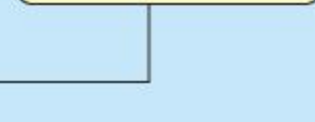
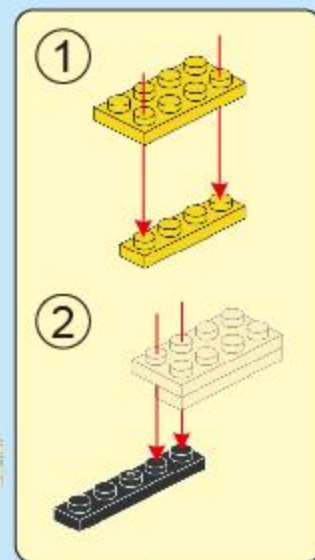
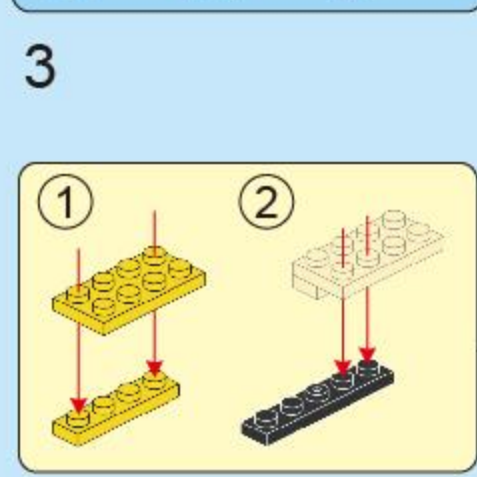
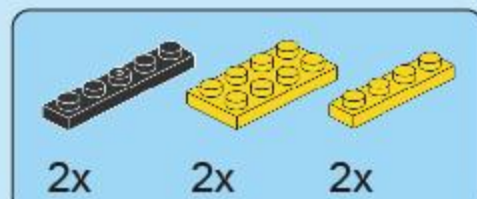
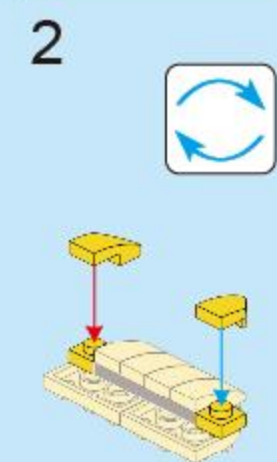
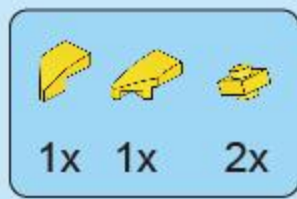
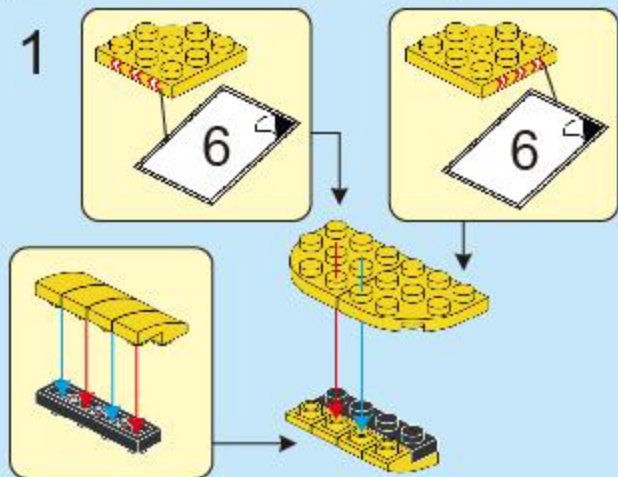
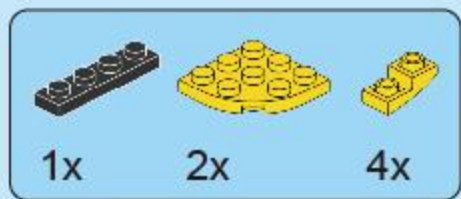

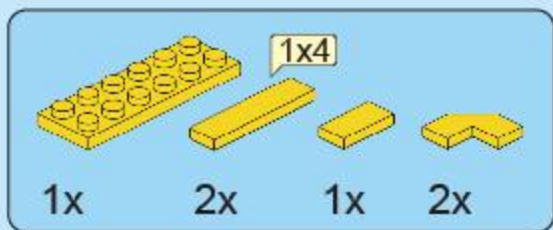

7

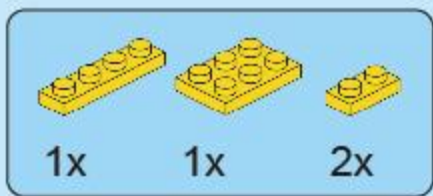
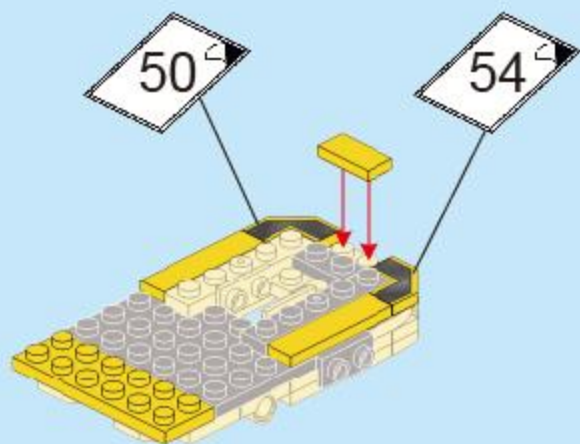

8

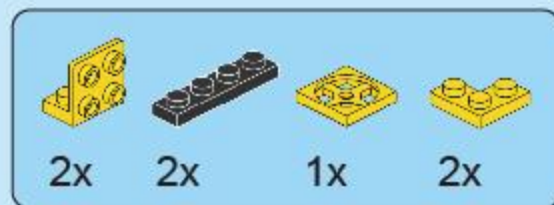
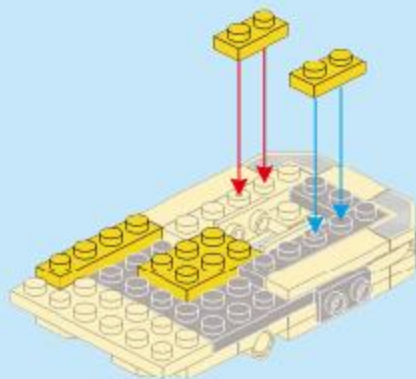

9

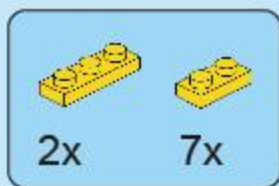
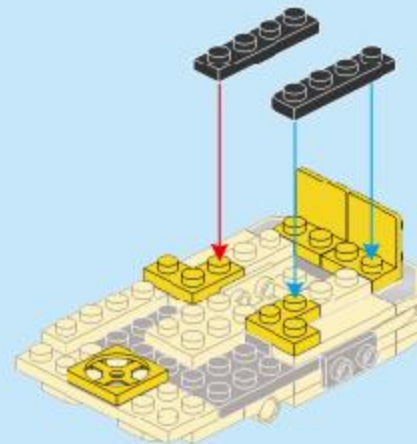

10

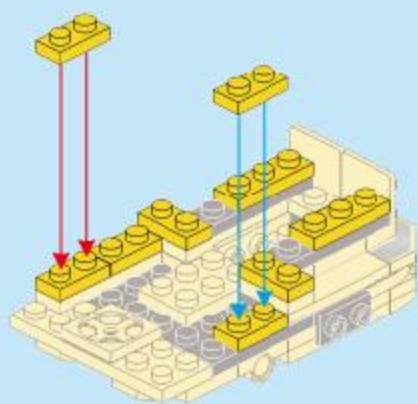

10

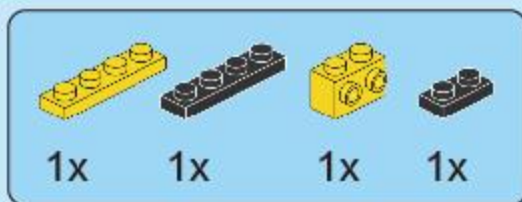

11

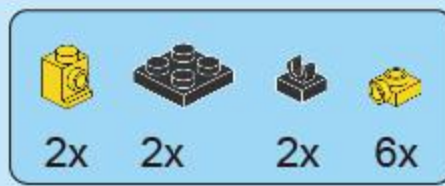
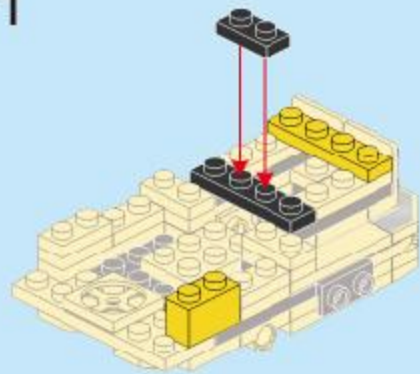

12

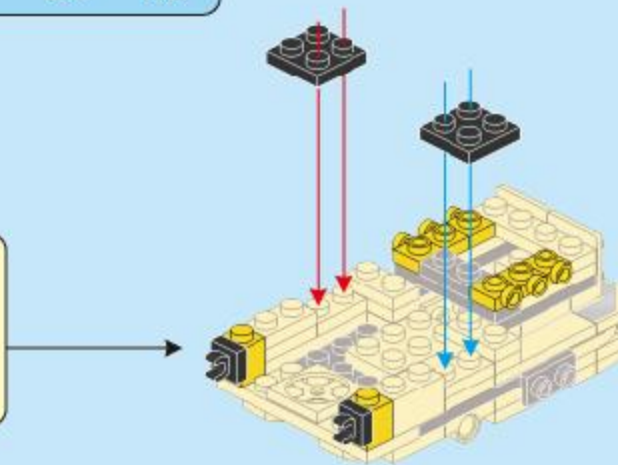
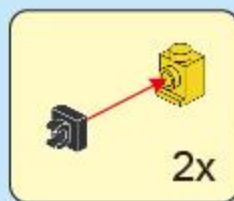

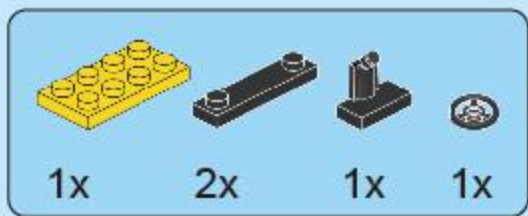

13

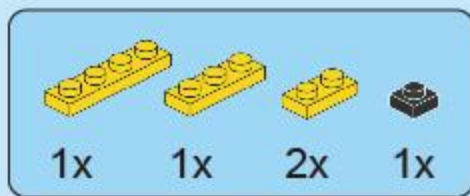
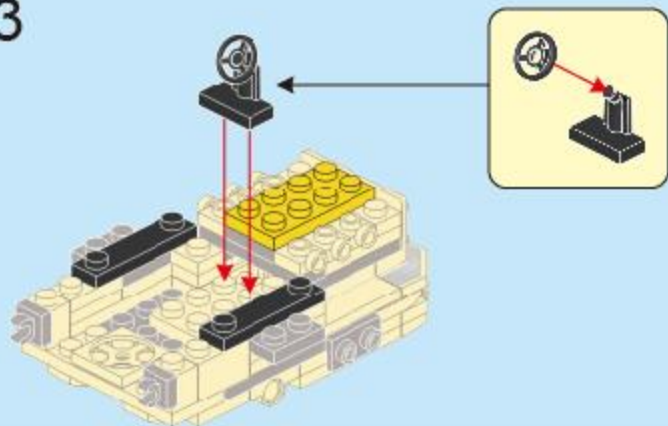

14

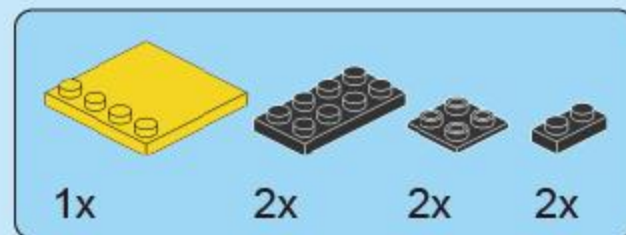
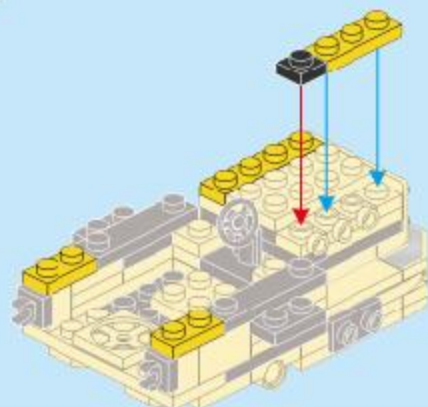

15

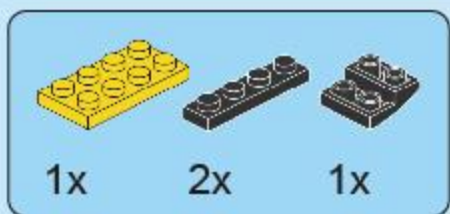
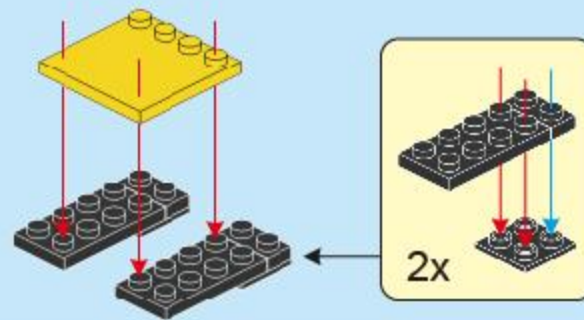

16

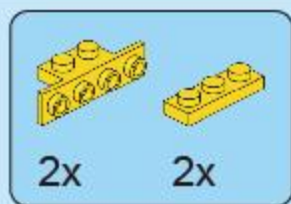
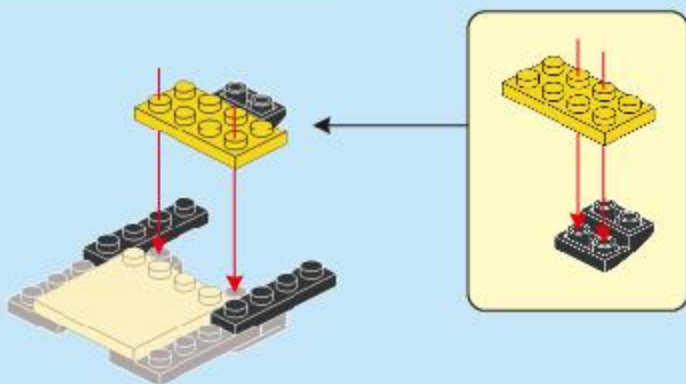

17

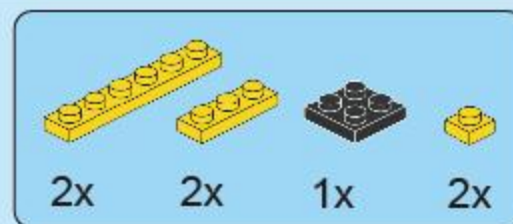
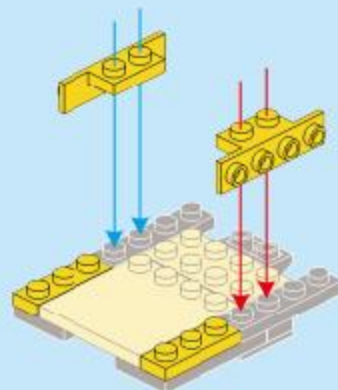

18



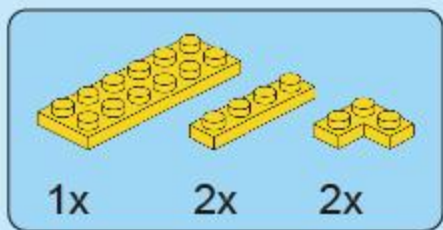

19

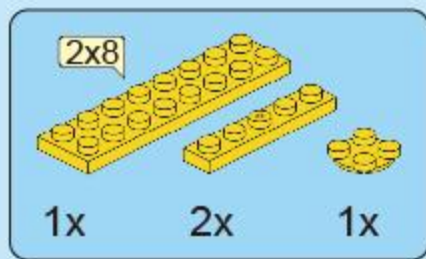
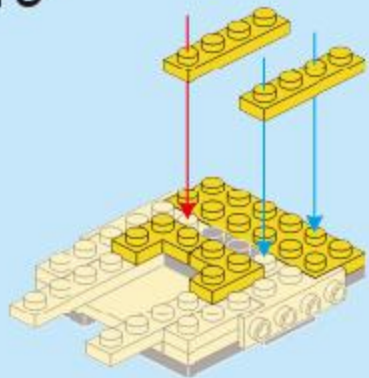

20

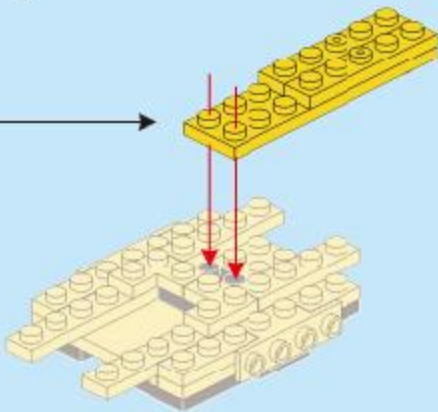
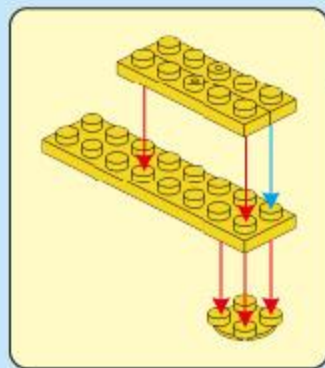

21

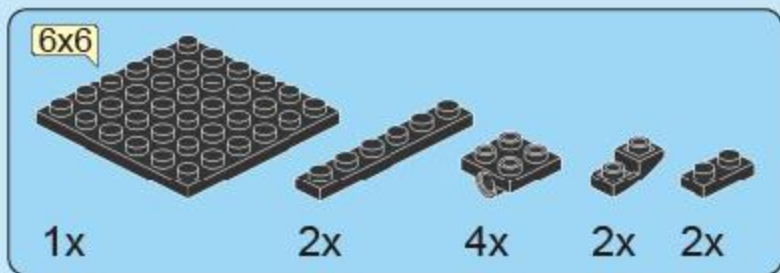
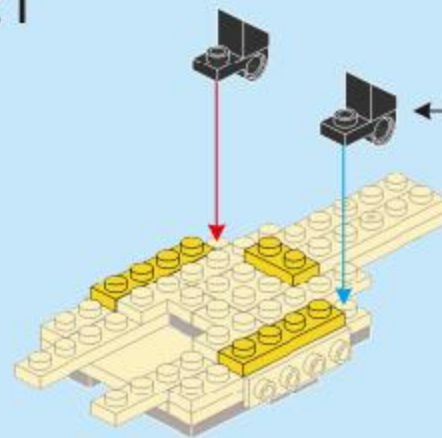

22

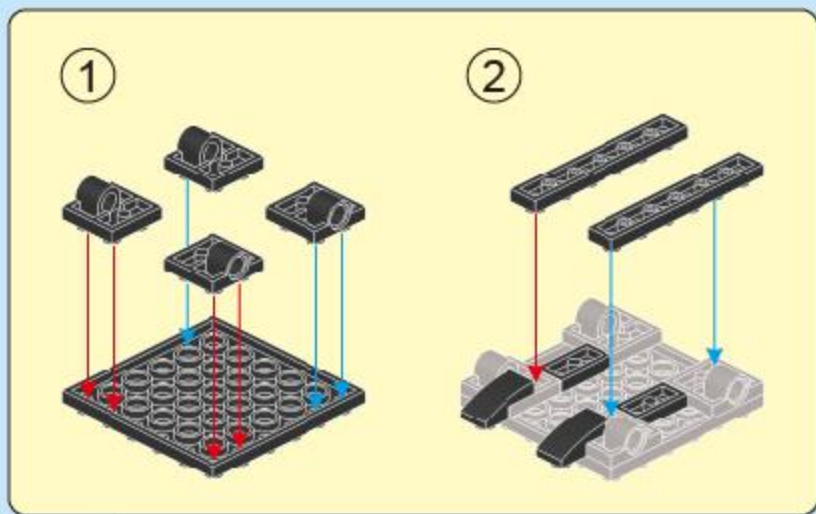
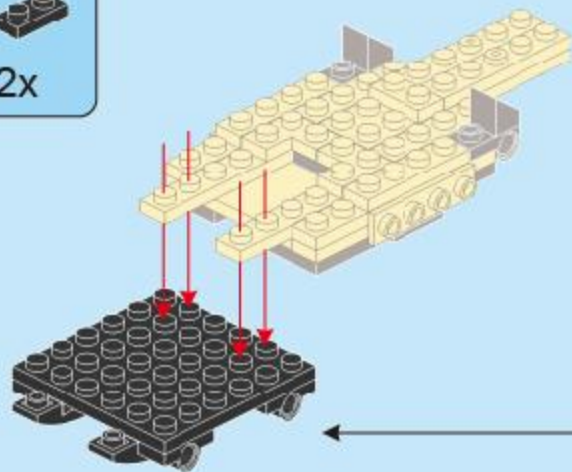

12

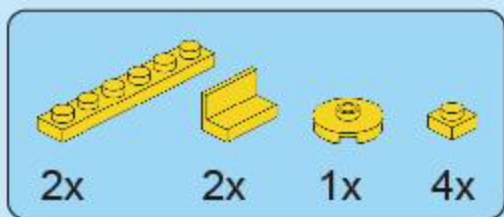

23

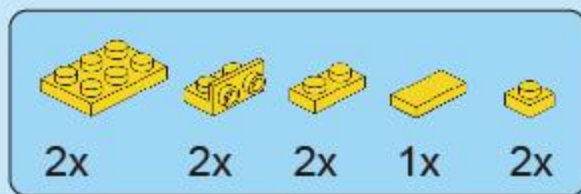
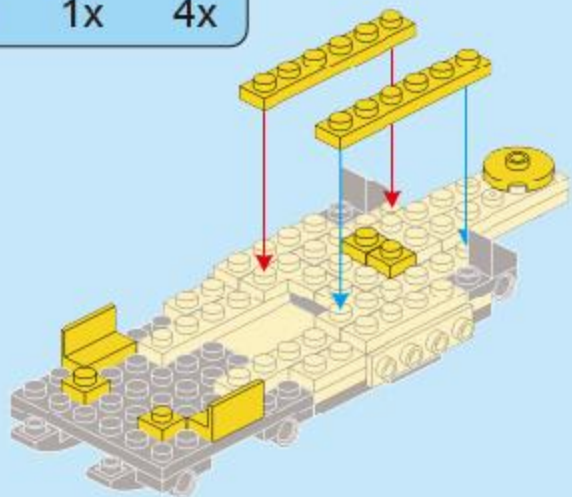

24

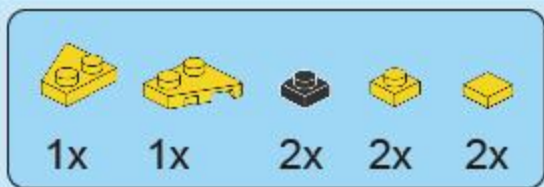
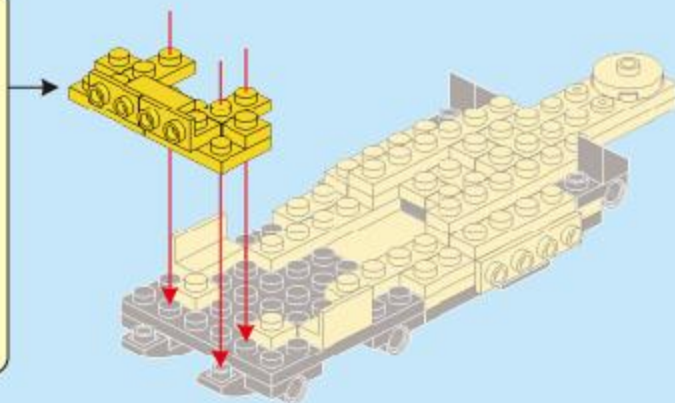
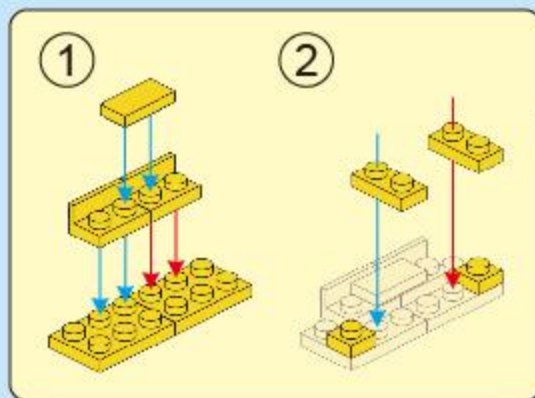

25

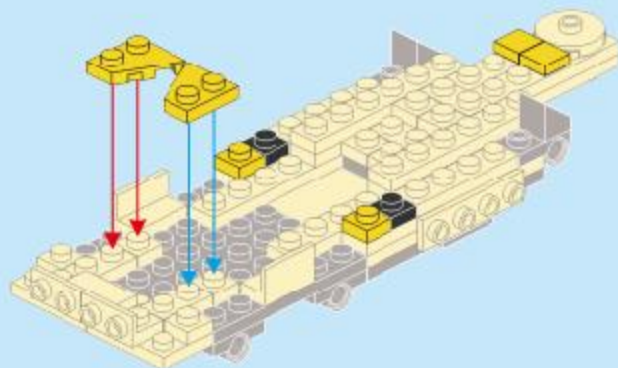

26

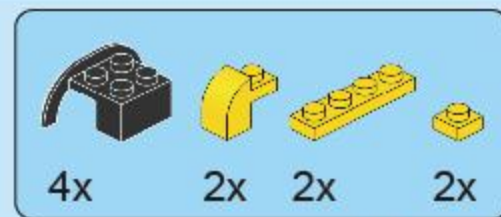
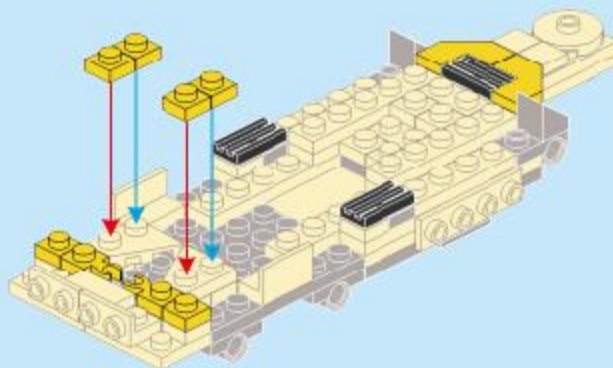

27

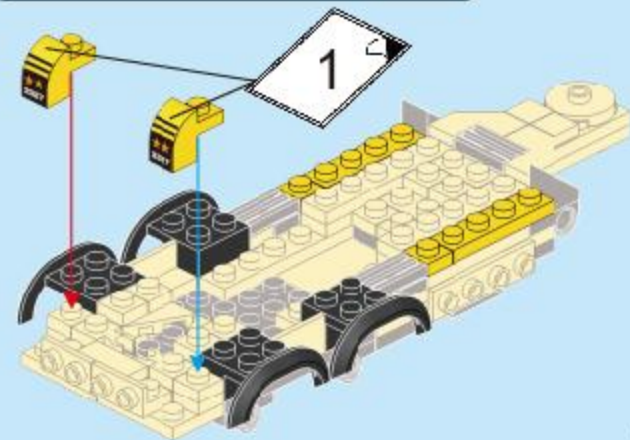

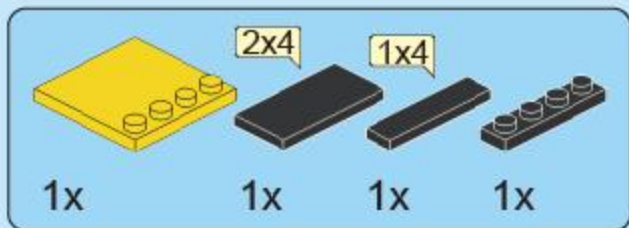

28

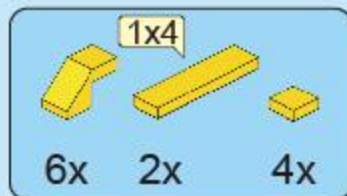
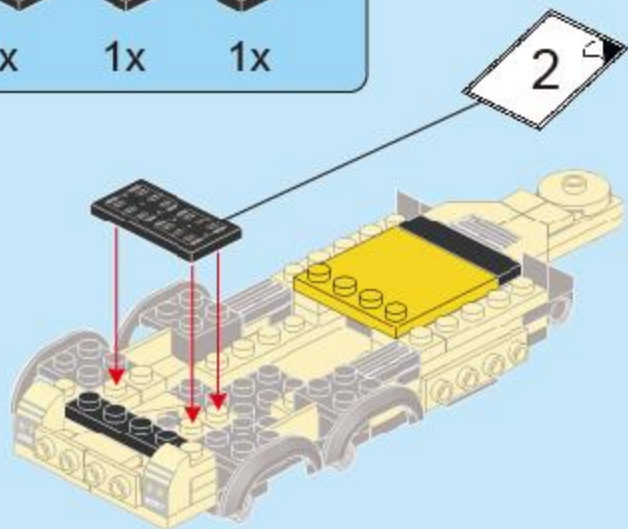

29

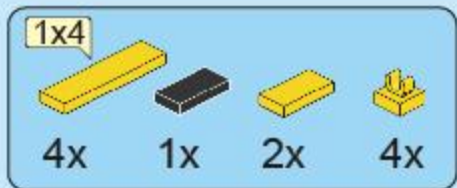
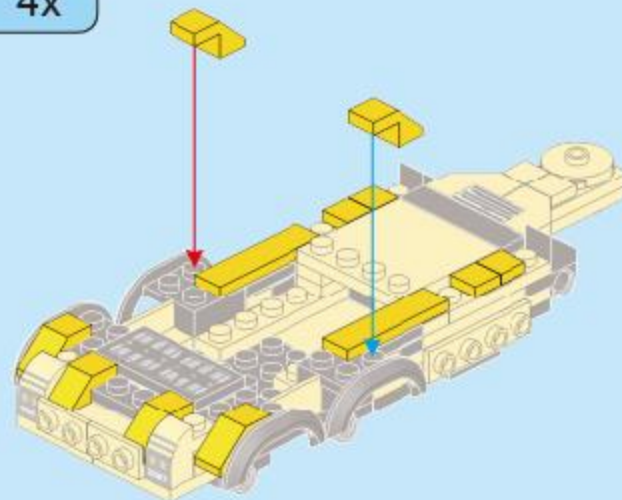

30

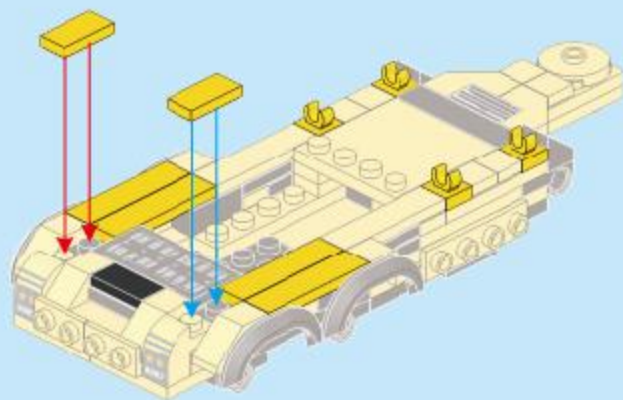

14

31

30

14

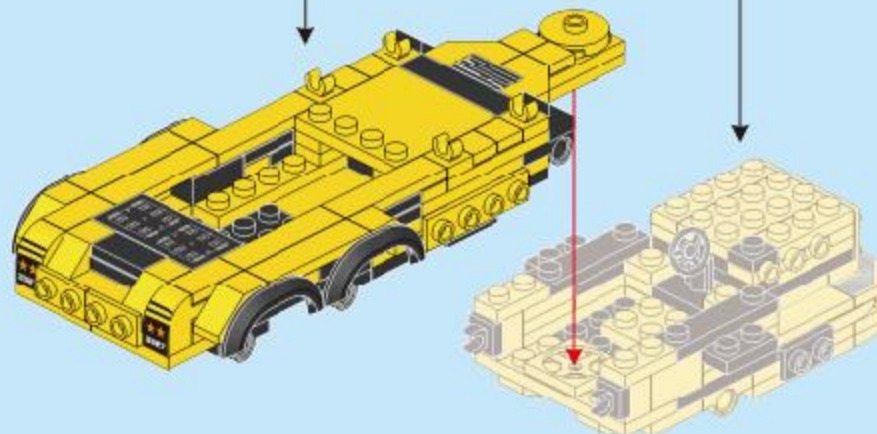

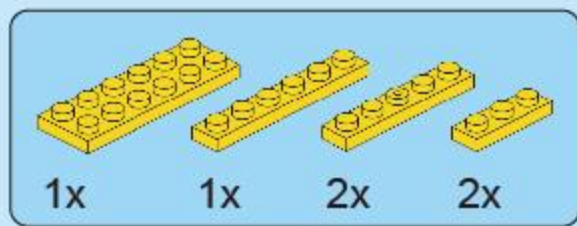

32

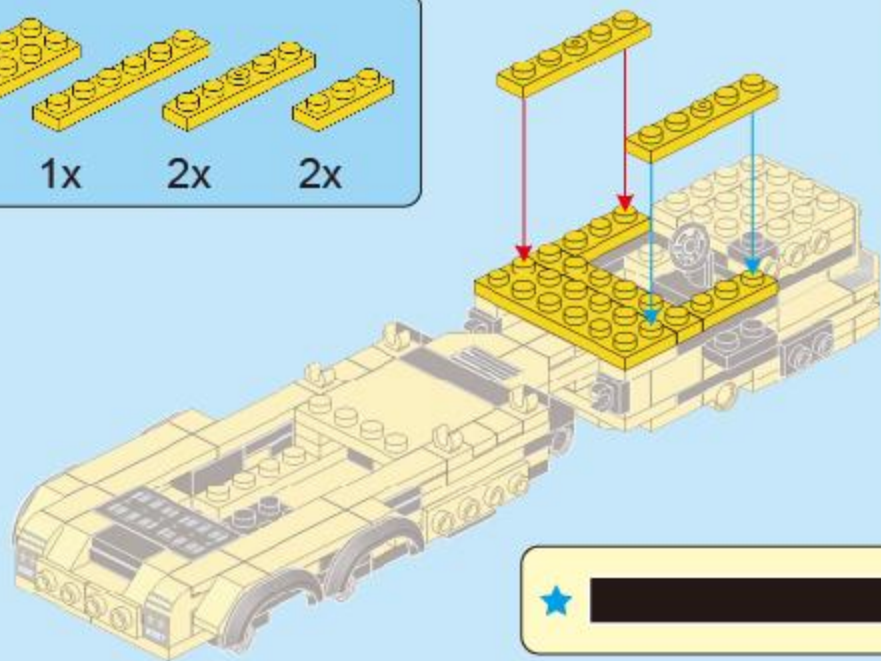

33

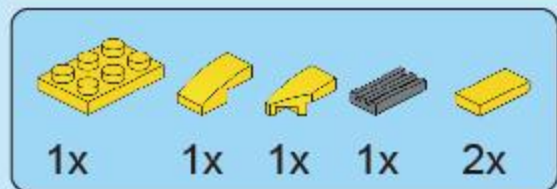
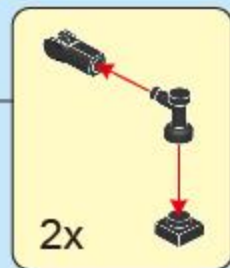
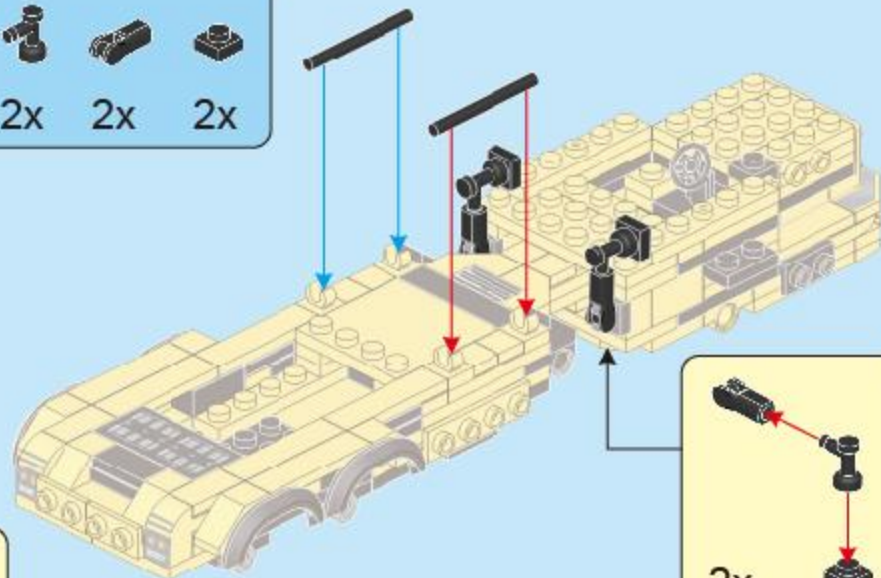

34

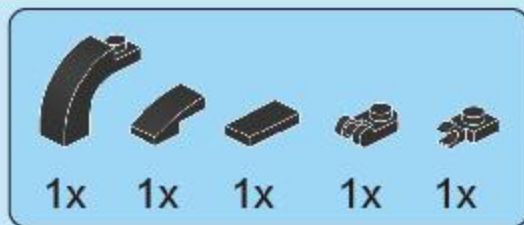
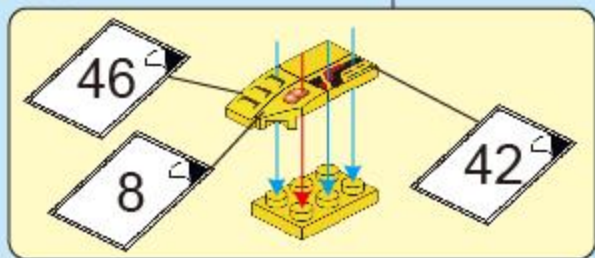
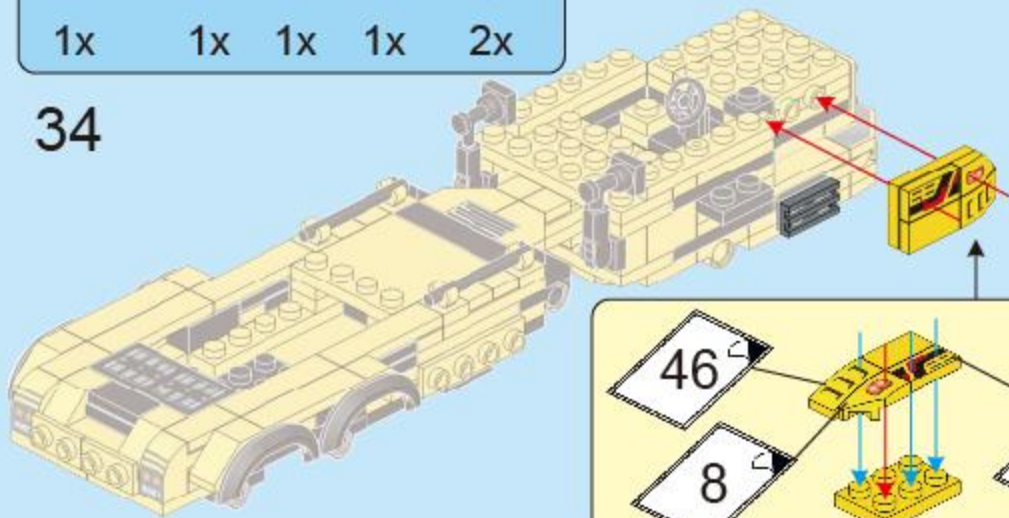

35

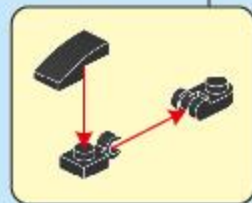
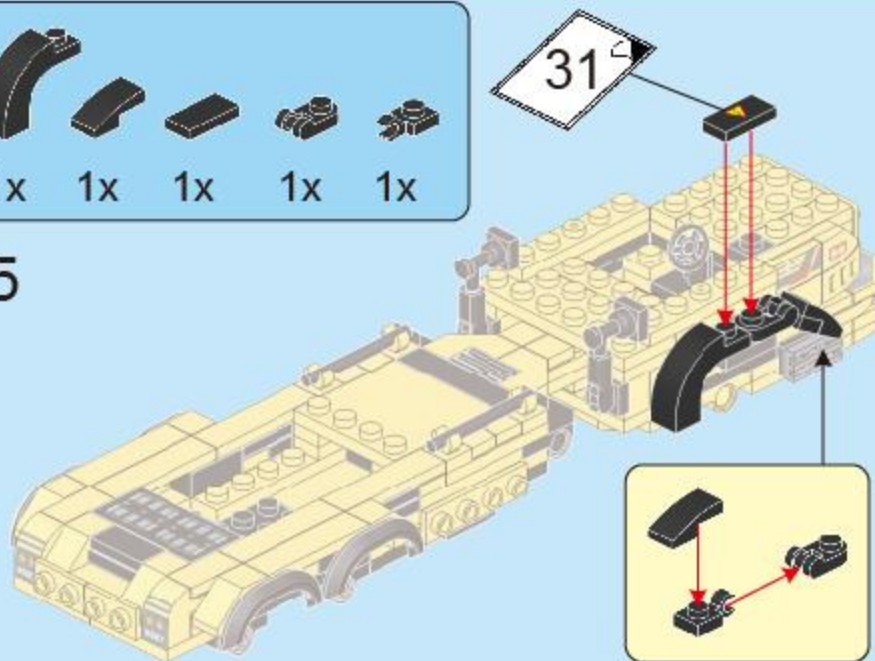

CITY

4 IN 1

